

 **HL IB Biology**

Protein Synthesis

Contents

- * Transcription in Protein Synthesis
- * Translation in Protein Synthesis
- * The Genetic Code
- * Protein Structure & Mutations
- * Mechanism of Transcription (HL)
- * Post-Transcriptional Modification (HL)
- * Translation & the Proteome (HL)



Your notes

Transcription in Protein Synthesis

Synthesis of RNA

- This process of protein synthesis occurs in **two stages**:
 - **Transcription** – DNA is transcribed and an **mRNA** molecule is produced
 - mRNA is a single stranded RNA molecule that transfers the information in DNA from the nucleus into the cytoplasm
 - mRNA production requires the enzyme RNA polymerase
 - **Translation** – **mRNA** (messenger RNA) is translated and an **amino acid sequence** is produced

The process of transcription

- This stage of protein synthesis occurs **in the nucleus** of the cell
- Part of a DNA molecule **unwinds** (the **hydrogen bonds** between the complementary base pairs **break**)
- This exposes the **gene** to be transcribed (the gene from which a particular polypeptide will be produced)
- A complementary copy of the code from the gene is made by building a **single-stranded nucleic acid molecule known as mRNA** (messenger RNA)
- **Free RNA nucleotides** pair up (via hydrogen bonds) with their complementary (now exposed) bases on one strand (the template strand) of the 'unzipped' DNA molecule
- The sugar-phosphate groups of these RNA nucleotides are then **bonded** together by the enzyme **RNA polymerase** to form the sugar-phosphate backbone of the mRNA molecule
- When the gene has been transcribed (when the mRNA molecule is complete), the hydrogen bonds between the mRNA and DNA strands break and the **double-stranded DNA molecule re-forms**
- The mRNA molecule then **leaves the nucleus** via a pore in the nuclear envelope
 - This is where the term *messenger* comes from – the mRNA is despatched, **carrying a message**, to another part of the cell
 - DNA can't make this journey; **it's too big to fit** through the pores in the nuclear envelope

Transcription in the nucleus diagram



Your notes

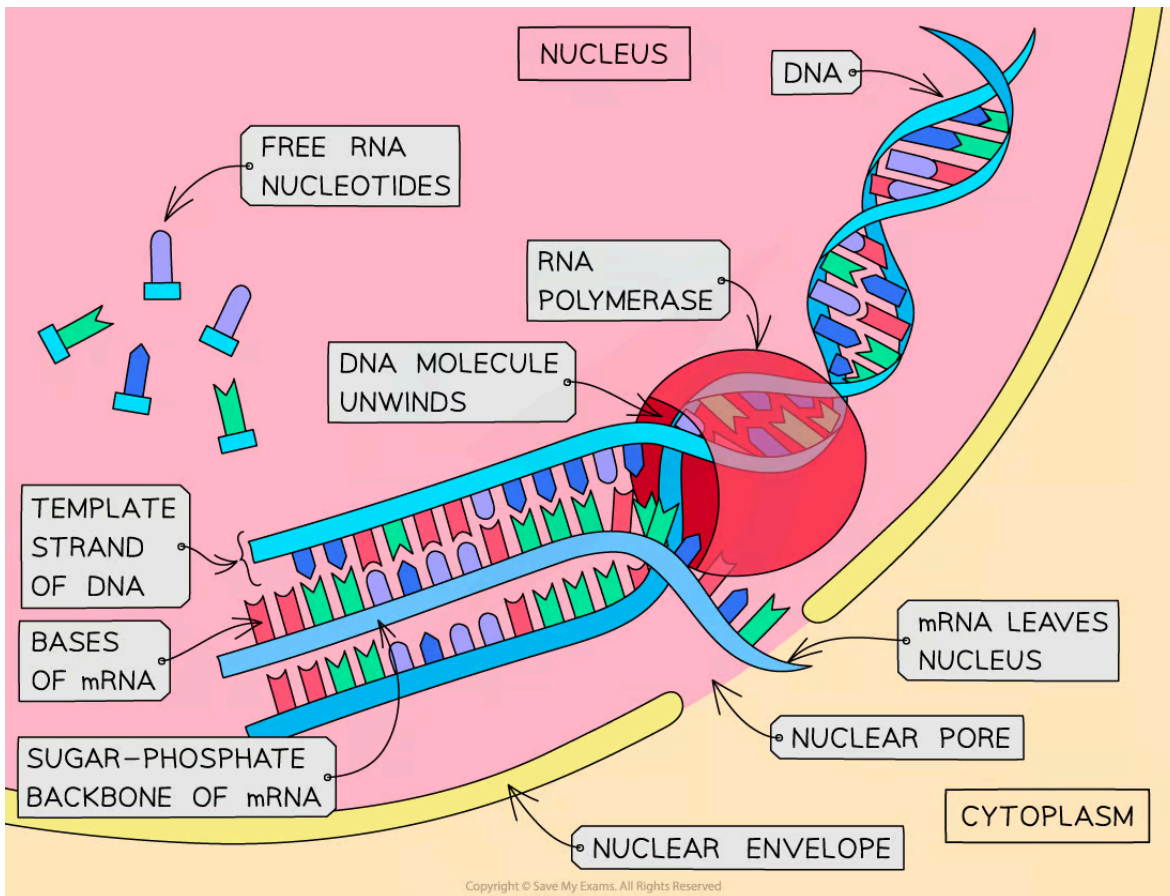

DNA is transcribed and an mRNA molecule is produced

 **Examiner Tip**

Be careful - DNA polymerase is the enzyme involved in DNA replication; RNA polymerase is the enzyme involved in transcription - don't get these confused.



Your notes

Hydrogen bonding & Complementary Base Pairing

- In the **transcription** stage of protein synthesis, free RNA nucleotides pair up with the exposed bases on the DNA molecule but **only with those bases on one strand of the DNA molecule**
- The RNA will have a complementary base sequence to the DNA strand and will bind to the DNA using **hydrogen bonds**
- The **adenine of the DNA is complementary to uracil on the new RNA strand**, because a thymine RNA nucleotide does not exist

Complementary base pairing between the DNA and the RNA transcript table

DNA template strand code	TAC	GGA	AGA	CTT	GGG
RNA transcript	AUG	CCU	UCU	GAA	CCC

- The strand of the DNA molecule that carries the genetic code is called the **coding strand**
- The opposite DNA strand is called the **template strand**
- To get an **RNA transcript of the coding strand**, the **template strand is the one that is transcribed** to form the mRNA molecule
 - This mRNA molecule will later be translated into an amino acid chain

DNA coding and template strand during transcription diagram

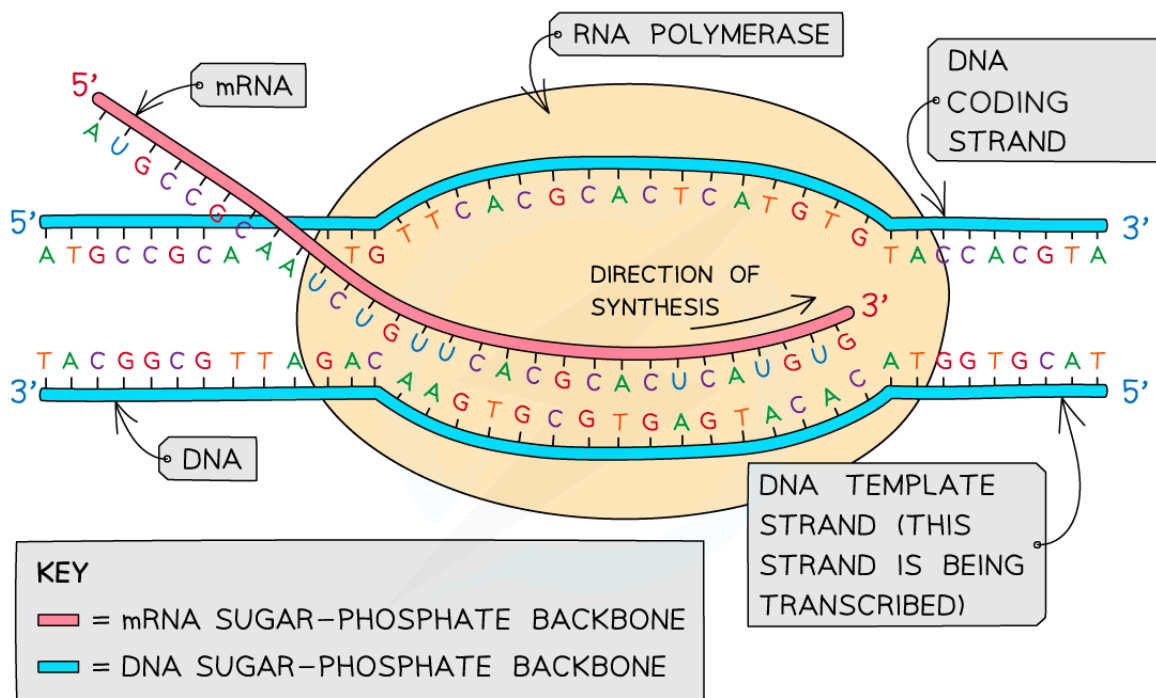

The template strand of the DNA molecule is the one that is transcribed



Your notes

DNA Templates

- DNA is a **very stable** molecule due to the **hydrogen bonding** between the DNA bases of the two strands and the strong phosphodiester bonds between adjacent nucleotides in each strand
 - This means that the genetic code is **not prone to spontaneously breaking or changing**
- This feature allows single DNA strands to act as **reliable templates for transcription** over several generations of cell replication
- In certain types of somatic cells that do not divide during their lifetimes, such as neurones and some types of muscle cells, the genetic sequence is **conserved** due to this stability and **does not degrade over time**

Transcription & Gene Expression

- There are approximately **20,000 protein-coding genes** in the human genome
- Not every protein is needed in every cell
 - For example, the insulin protein is not needed in cardiac muscles of the heart
- As a result, our specialised cells have a way of **switching certain genes off or on** to match the requirements of the cell. This is called **gene expression**
 - Genes that are expressed are 'switched on' and **undergo the process of transcription and translation**
 - Genes that are not expressed are 'switched off' or silenced, and do not go through the process of transcription and/or translation
- There are **various different mechanisms** in the cell involved in controlling gene expression
- **Transcription is the first stage of gene expression** and so this is a key stage at which gene expression can be switched on or off

Translation in Protein Synthesis



Your notes

Synthesis of Polypeptides

- **Translation** involves taking the genetic code from the mRNA and **synthesising a polypeptide**
 - A polypeptide is a sequence of amino acids covalently bonded together
 - The order of the amino acids is based on the information stored in the genetic code of the mRNA
- This stage of protein synthesis occurs **in the cytoplasm** of the cell
- The **mRNA template** comes from the process of **transcription**, and so translation always takes place following these events
 - After transcription the mRNA moves out of the nuclear pore and diffuses into the cytoplasm towards the ribosome for translation

Examiner Tip

Make sure you learn both stages of protein synthesis fully. Don't forget WHERE these reactions take place – transcription occurs in the nucleus but translation occurs in the cytoplasm!



Your notes

Roles of RNA & Ribosomes in Translation

- After leaving the nucleus, the **mRNA molecule attaches to a ribosome**
- A ribosome is a complex structure that is made of a large and small subunit
 - Ribosomes are themselves made of **proteins** and **RNA** (called ribosomal RNA or **rRNA**)
- There are **binding sites on the subunits** for the various other molecules involved in translation
 - The **mRNA** binds to the **small subunit**
 - **Two tRNA** molecules are able to bind to the **large subunit simultaneously**

mRNA in the ribosome diagram

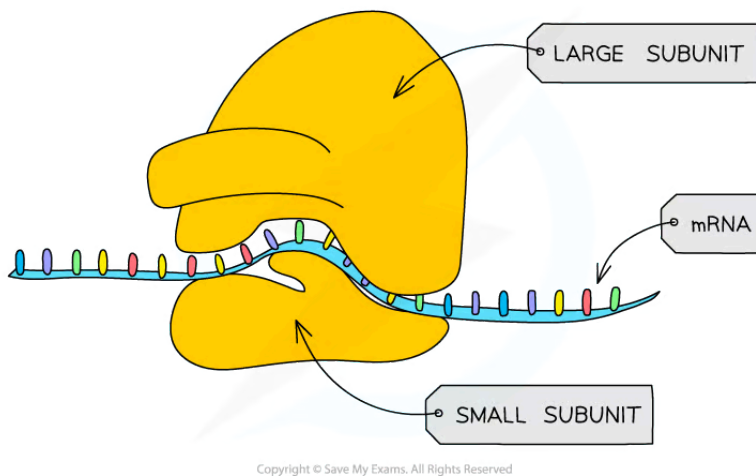

A ribosome is built of large and small subunits, ribosomal RNA and an area on the surface that catalyses the formation of peptide bonds in a newly-synthesised protein

- Translation depends on complementary base pairing between codons on mRNA and anticodons on tRNA
- In the cytoplasm, there are **free molecules of tRNA** (transfer RNA)
- The **tRNA molecules bind with their specific amino acids** (also in the cytoplasm) and bring them to the mRNA molecule on the **ribosome**
- The triplet of bases (anticodon) on each tRNA molecule pairs with a complementary triplet (codon) on the mRNA molecule

tRNA and mRNA before translation diagram



Your notes

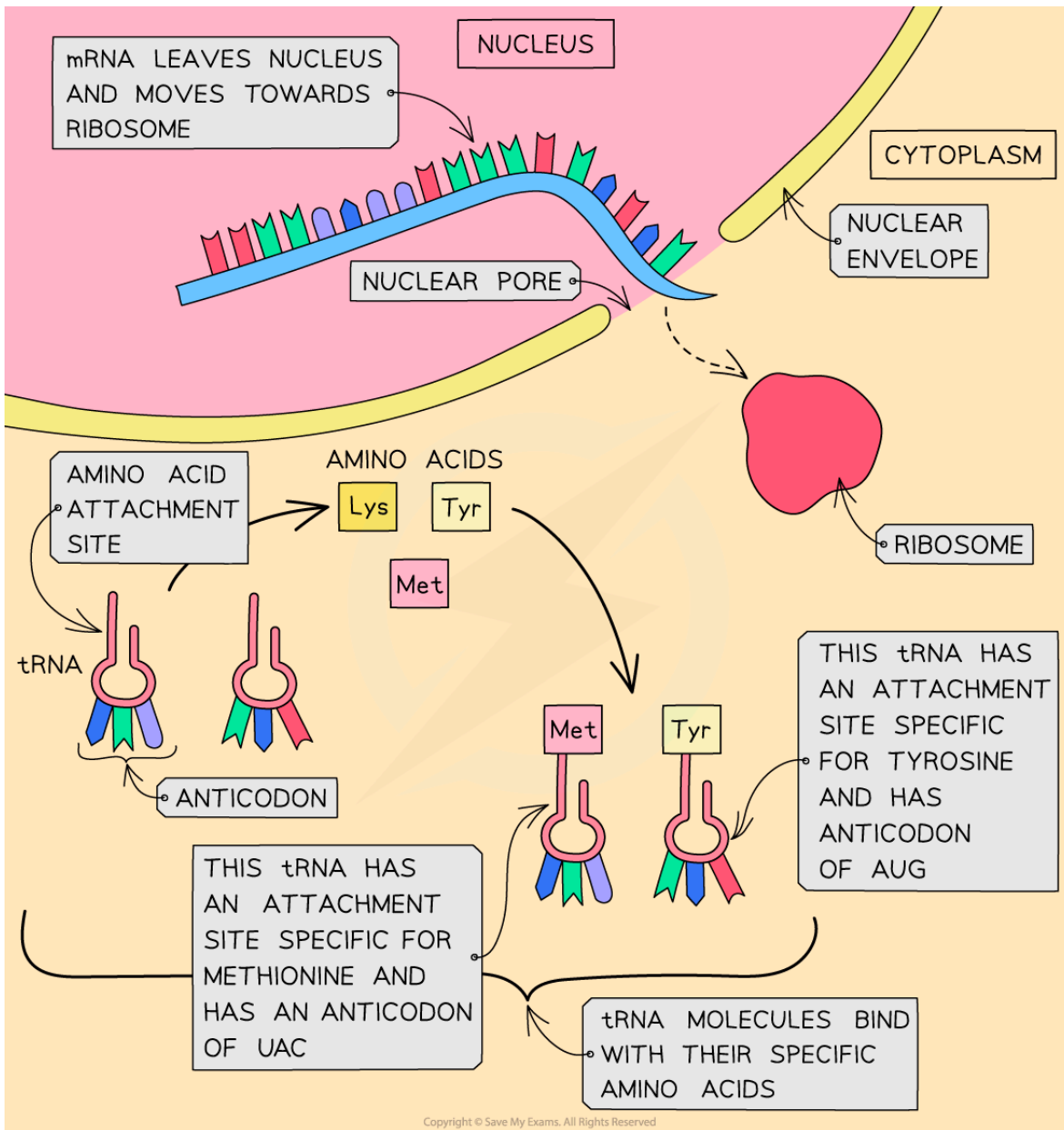

The translation stage of protein synthesis – tRNA molecules bind with their specific amino acids



Your notes

Codons & Anticodons

- Codons of **three bases** on mRNA correspond to **one amino acid** in a polypeptide
 - A **triplet** is a sequence of three DNA bases that codes for a specific amino acid
 - A **codon** is a sequence of three **mRNA** bases that codes for a specific amino acid
 - A codon is transcribed from the triplet and is complementary to it
- An **anticodon** is a sequence of three **transfer RNA (tRNA)** bases that are complementary to a codon
 - The transfer RNA **carries the appropriate amino acid** to the ribosome
 - The amino acid can then be condensed **onto the growing polypeptide chain**
- Certain codons carry the command to **stop translation** when the polypeptide chain is complete. These are called **stop codons**

Structure of tRNA diagram

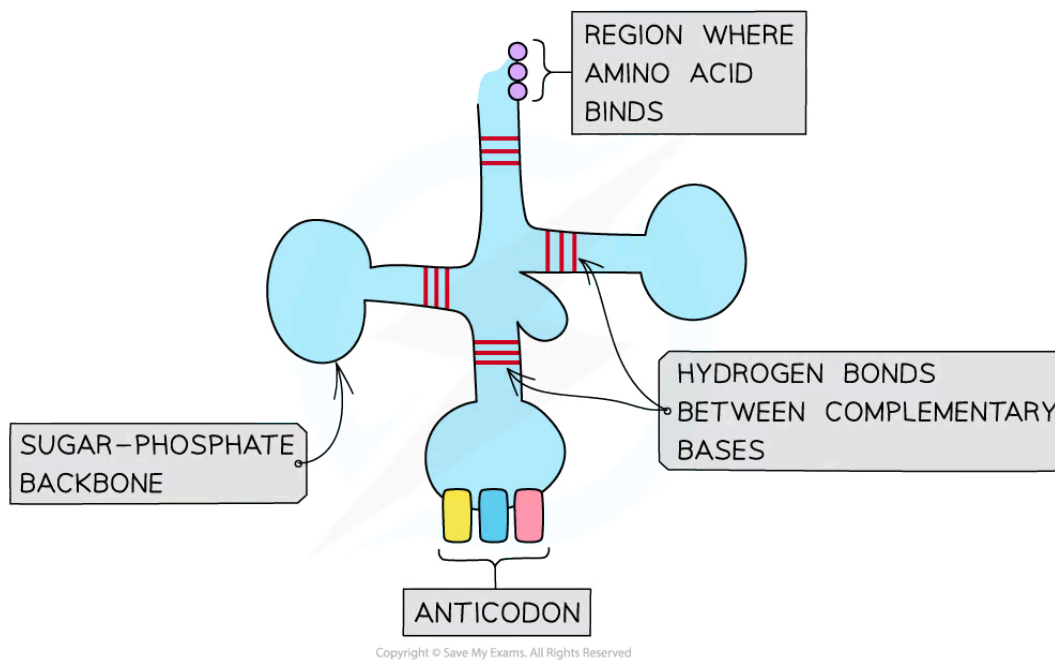

The anticodon is positioned at the bottom of the tRNA molecule and consists of three exposed RNA bases

mRNA and tRNA binding diagram



Your notes

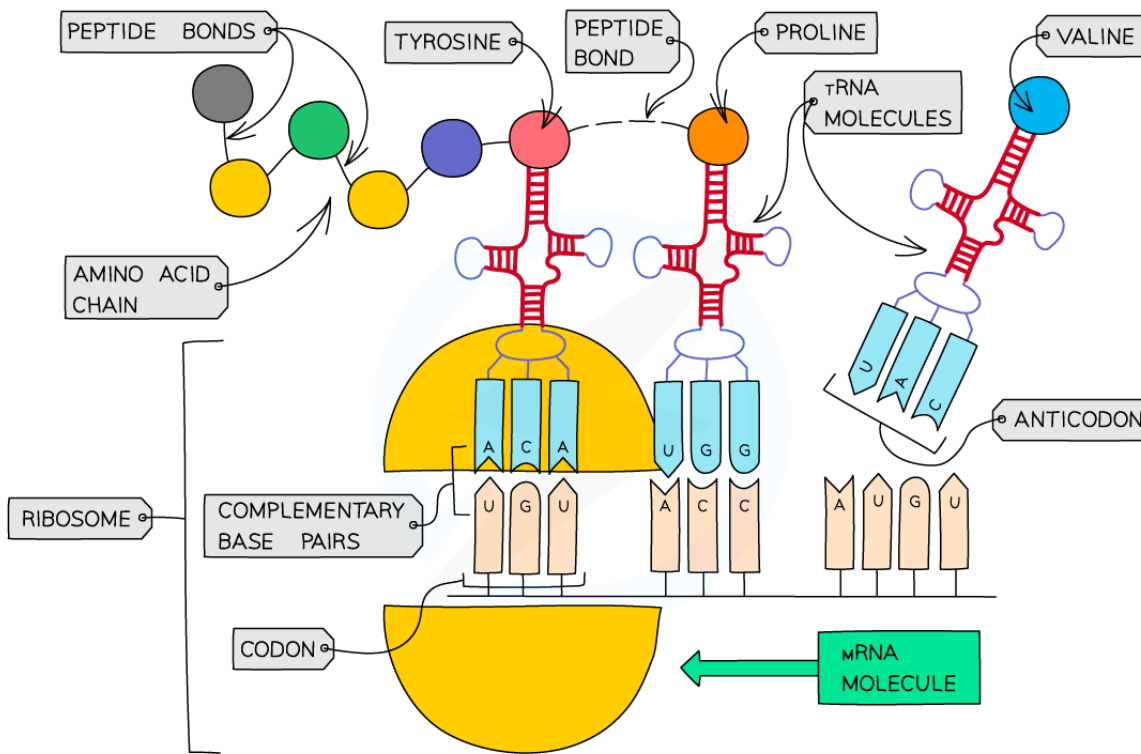

Copyright © Save My Exams. All Rights Reserved



Complementary base pairing occurs between the mRNA and the corresponding tRNA molecule, resulting in the correct sequence of amino acids being synthesised into the polypeptide

Analogy: Think of transcription and translation as being like converting between languages

- Each language has its **alphabet**, just as nucleic acids and proteins have their **monomers**
- **Transcription** is like converting text from **English** to **French**
 - The same characters are used, but there are slight differences
 - French uses the same alphabet as English but employs occasionally accented characters like â, é, or ç
 - DNA and RNA employ largely the same monomers but with slight differences in the two pentose sugars and U replacing T.
- **Translation** is like converting text from a Western language to a language that uses a different alphabet, like **Japanese**
 - A completely **different set of characters** is used
 - The sequence of characters is **unrecognisable** from the original
 - If we could see them, a chain of amino acids would look nothing like a chain of nucleotides

Transcription and Translation Can be Likened to the Conversion Between Languages Table



Your notes

Transcription	DNA → RNA	Similarities	English → French		Similarities
DNA → RNA	TTACAGCTC → AAUGUCGAG	Both use a similar set of monomers (with a slight difference; U replaces T)	"I received biology lessons at my school"	"J'ai reçu des cours de biologie à mon école"	Both use a similar alphabet (with slight differences: ç, à, é, Ô etc)

Translation	RNA → Protein	Differences	French → Japanese		Differences
RNA → protein	AAUGUCGAG → Asn-Val-Glu	Both use different monomers (nucleotides & amino acids)	"J'ai reçu des cours de biologie à mon école"	学校で生物学の授業を受けました	Both use different alphabets

Copyright © Save My Exams. All Rights Reserved

Examiner Tip

Remember that complementary base pairing in RNA means that:

- Adenine (A) will pair up with Uracil (U)
- Cytosine (C) will pair up with Guanine (G)

So if an mRNA codon has a sequence of **CAG**, then its complementary tRNA anticodon will have a sequence of **GUC**.



Your notes

The Genetic Code

Features of the Genetic Code

- The sequence of DNA nucleotide bases found within a gene is determined by a **triplet** (three-letter) **code**
- Each sequence of **three bases** (i.e. each triplet of bases) in a gene codes for **one amino acid**
- These triplets code for different amino acids – there are 20 different amino acids that cells use to make up different proteins
- For example:
 - CAG codes for the amino acid valine
 - TTC codes for the amino acid lysine
 - GAC codes for the amino acid leucine
 - CCG codes for the amino acid glycine
- Some of these triplets of bases code for **start** (TAC – methionine) **and stop signals**
- These start and stop signals **tell the cell where individual genes start and stop**
- As a result, the cell **reads the DNA correctly** and **produces the correct sequences of amino acids** (and therefore the correct protein molecules) that it requires to function properly
- The genetic code is **non-overlapping**
 - Each base is **only read once** in which codon it is part of
- There are **four bases**, so there are **64** different codons (triplets) possible ($4^3 = 64$), yet there are only 20 amino acids that commonly occur in biological proteins
 - This is why the code is said to be **degenerate**: multiple codons can code for the same amino acids
 - The degenerate nature of the genetic code can **limit** the effect of **mutations**
- The genetic code is also **universal**, meaning that almost every organism uses the **same code** (there are a few rare and minor exceptions)
- The **same triplet codes code for the same amino acids in all living things** (meaning that genetic information is transferable between species)
 - The universal nature of the genetic code is why genetic engineering (the transfer of genes from one species to another) is possible

Deducing Amino Acid Sequences

- By observing the **genetic code in the mRNA** it is possible to determine the **sequence of amino acids** that are coded for in the **polypeptide**



Your notes

mRNA codons and amino acids table

		SECOND LETTER				
		U	C	A	G	
FIRST LETTER	U	UUU } Phe UUC } UUA } Leu UUG }	UCU } UCC } Ser UCA } UCG }	UAU } Tyr UAC } UAA Stop UAG Stop	UGU } Cys UGC } UGA Stop UGG Trp	U C A G
	C	CUU } CUC } Leu CUA } CUG }	CCU } CCC } CCA } Pro CCG }	CAU } His CAC } CAA } Gln CAG }	CGU } CGC } CGA } Arg CGG }	U C A G
	A	AUU } AUC } Ile AUA } AUG Met	ACU } ACC } Thr ACA } ACG }	AAU } Asn AAC } AAA } Lys AAG }	AGU } Ser AGC } AGA } Arg AGG }	U C A G
	G	GUU } GUC } Val GUA } GUG }	GCU } GCC } Ala GCA } GCG }	GAU } Asp GAC } GAA } Glu GAG }	GGU } GGC } Gly GGA } GGG }	U C A G
						THIRD LETTER

Copyright © Save My Exams. All Rights Reserved



Your notes

Worked example

Use the **rules of base-pairing** and the **mRNA Codons and Amino Acids Table** (above) to deduce the amino acid sequence coded for by the following DNA **coding strand** sequence TTC GAG CATTAC GCC

Answer:

Step 1: Work out the template sequence using A-T and C-G base pairing rules

AAG CTC GTA ATG CGG

Step 2: Work out the mRNA codons, complementary to the template strand

UUC GAG CAU UAC GCC

Step 3: Use the mRNA Codons and Amino Acids Table (above) to work out the first amino acid

First base in codon = U, second base = U, third base = C

So we're looking in the top-left box of the table; this amino acid is **Phe**

Step 4: Repeat for the remaining 4 codons

GAG = Glu

CAU = His

UAC = Tyr

GCC = Ala

The final sequence of amino acids is Phe-Glu-His-Tyr-Ala

Elongation of the Polypeptide Chain

- During translation **two tRNA molecules fit onto the ribosome at any one time**, bringing the amino acid they are each carrying side by side
 - The ribosome will move along the mRNA molecule, one codon at a time
- A **peptide bond** is then formed (by condensation) between the two amino acids
 - The formation of a peptide bond between amino acids is an anabolic reaction
 - It **requires energy**, in the form of **ATP**
 - The ATP needed for translation is provided by the **mitochondria** within the cell
- This process continues until a '**stop**' **codon** on the mRNA molecule is reached – this acts as a signal for translation to stop and at this point the amino acid chain coded for by the mRNA molecule is complete
- This amino acid chain is then **released from the ribosome** and forms the final polypeptide

The process of translation diagram



Your notes



Your notes

1 IN THE CYTOPLASM THE mRNA ATTACHES TO A RIBOSOME

2 EACH tRNA HAS THE COMPLEMENTARY ANTICODON TO THE CODON ON THE mRNA

3 THE FIRST tRNA (WHICH ALWAYS CARRIES THE METHIONINE AMINO ACID) FORMS HYDROGEN BONDS WITH THE FIRST OR 'START' CODON (AUG) ON THE mRNA.

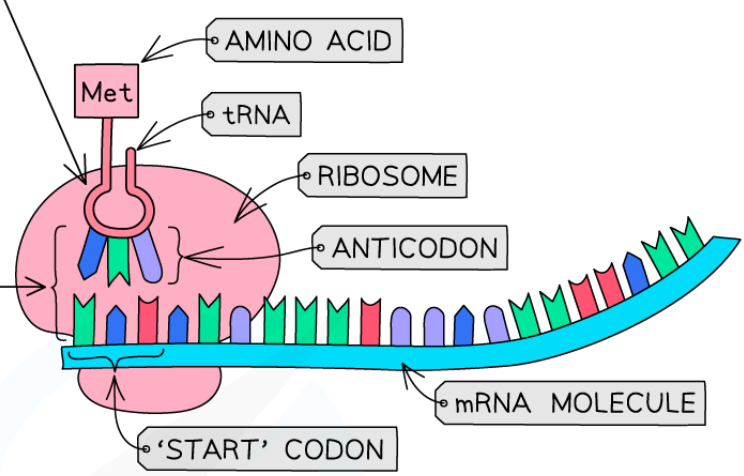

5 A PEPTIDE BOND FORMS BETWEEN THE AMINO ACIDS

4 THE SECOND tRNA (BRINGING THE SECOND AMINO ACID) BONDS WITH THE NEXT CODON ON THE mRNA

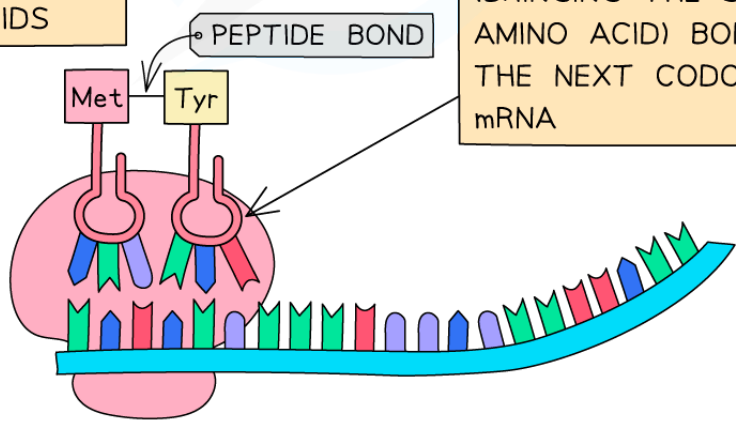

6 THE RIBOSOME MOVES ALONG THE mRNA (IN A 5' TO 3' DIRECTION) 'READING' THE NEXT CODON

Copyright © Save My Exams. All Rights Reserved



Your notes

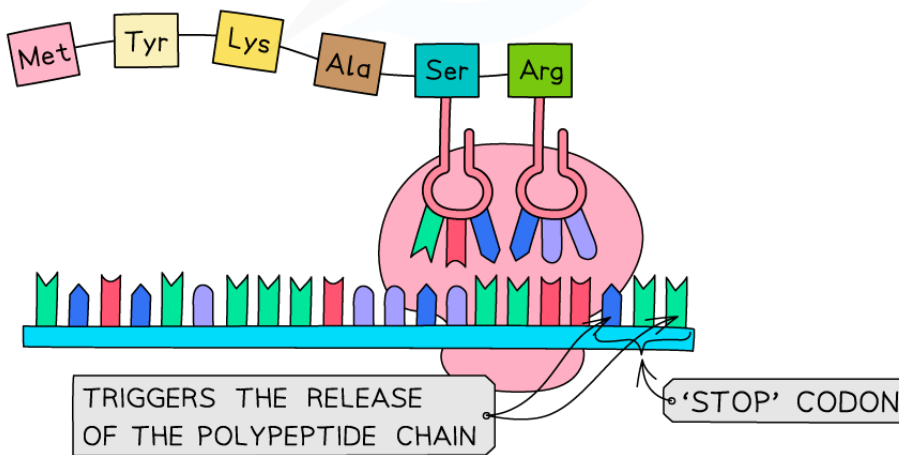
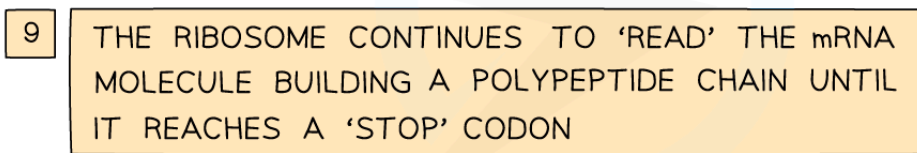
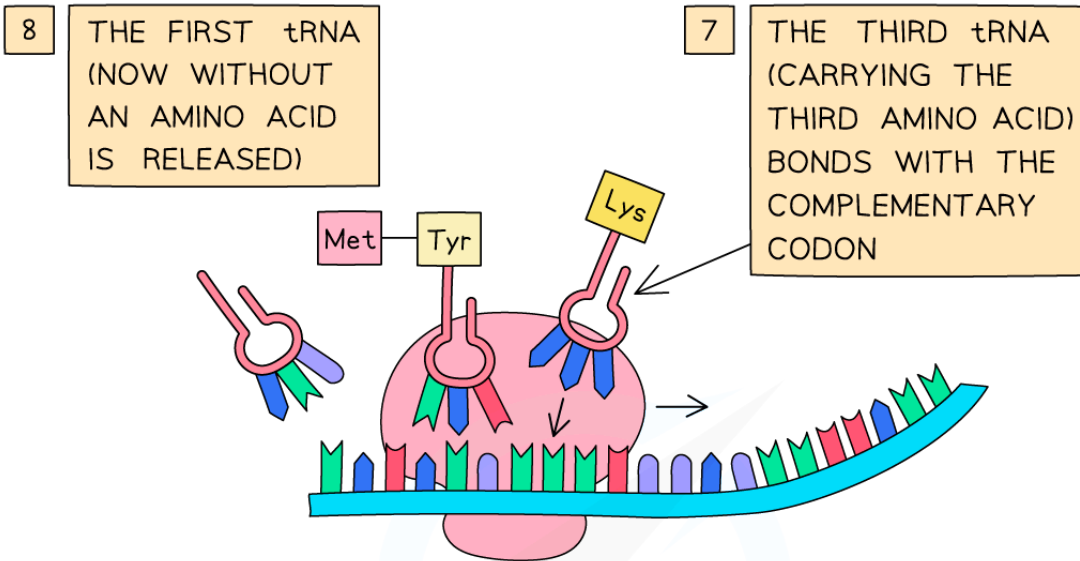

Copyright © Save My Exams. All Rights Reserved

The translation stage of protein synthesis – an amino acid chain is formed



Your notes

Protein Structure & Mutations

Protein Structure & Mutations

- A **gene mutation** is a change in the sequence of bases in a DNA molecule; this may result in a new allele
 - Mutations occur **all the time** and occur **randomly**
 - Mutations are **copying errors** that take place when DNA is replicated during **S phase** of interphase
- As the DNA base sequence determines the sequence of amino acids that make up a polypeptide, **mutations in a gene** can sometimes lead to a **change in the polypeptide** for which the gene codes
- Most mutations are **harmful** or **neutral** (have no effect) but some can be **beneficial**
- **Inheritance** of mutations:
 - Mutations present in normal body cells are **not inherited**; they are eliminated once the affected cells die
 - Mutations within gametes are inherited by offspring, so can lead to **heritable** genetic conditions
- **Point mutations** are mutations where **one base** in the DNA sequence is altered; this can result in a **changed amino acid** at this location

Example of a point mutation: sickle cell disease

- A small change to a gene can have **serious consequences** for an organism
- Sickle cell disease is a genetic disorder caused by **a single point mutation** within the gene that codes for the alpha-globin polypeptide in haemoglobin (Hb)
 - Most humans have the allele **Hb^A**
 - The mutation results in a new allele **Hb^S**

The sickle cell mutation

- Within the haemoglobin gene a point mutation changes the DNA triplet **GAG** to **GTG** on the coding strand
- The resulting DNA triplet (**CAC**) on the template strand is transcribed into the **mRNA codon GUG**, instead of **GAG**
- During translation the amino acid **valine** (Val) replaces the original amino acid **glutamic acid** (Glu)
 - This occurs at the **sixth position** of the polypeptide

Sickle cell anaemia point mutation diagram



Your notes

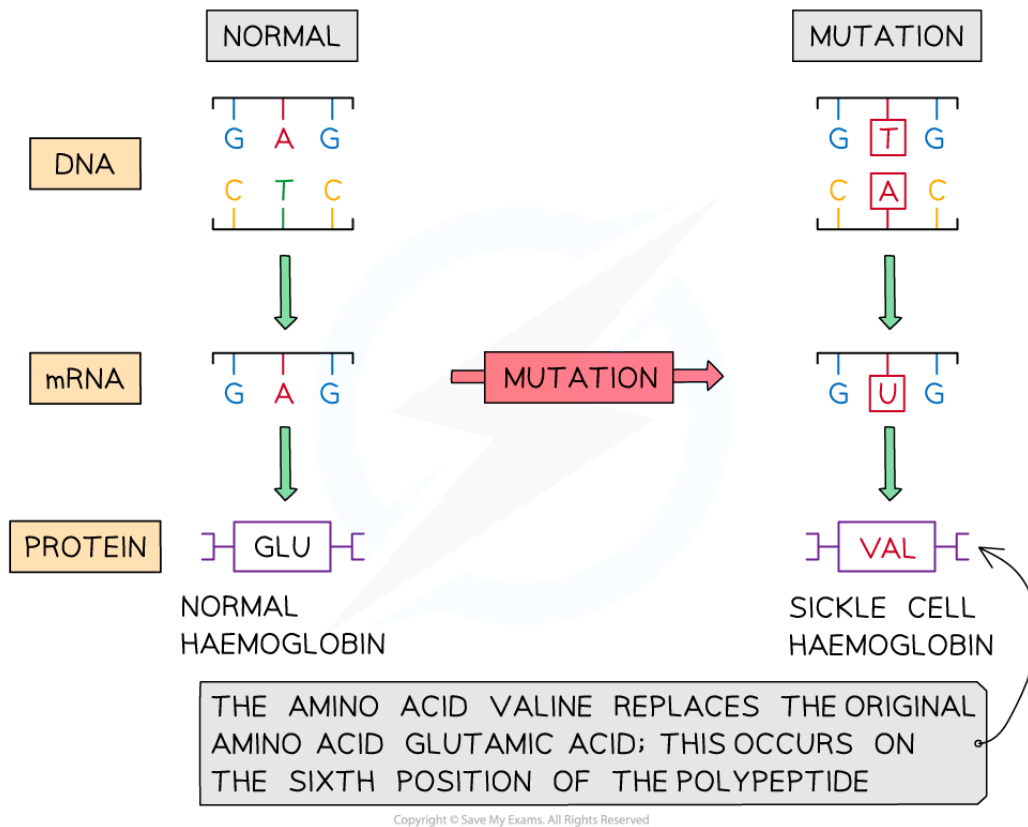

A base substitution on the DNA molecule results in a change in the amino acid at position 6 of the haemoglobin polypeptide, altering the overall structure and function of the protein

The effects

- The protein haemoglobin **S** is produced instead of haemoglobin A; this causes a **distortion in the shape of red blood cells**, resulting in a **sickle shape**
- Sickle-shaped red blood cells:
 - Have a **limited oxygen-carrying capacity**
 - **Block the capillaries** and limit the flow of normal red blood cells
- People with sickle cell anaemia suffer from **acute pain, fatigue** and **anaemia**
- There is a **correlation** between the global distribution of sickle cell disease and **malaria**
 - In areas with increased malaria cases there is an increased frequency of sickle cell alleles; this is thought to be due to increased resistance to the malaria parasite in individuals with the Hb^S allele

Sickled cells diagram



Your notes

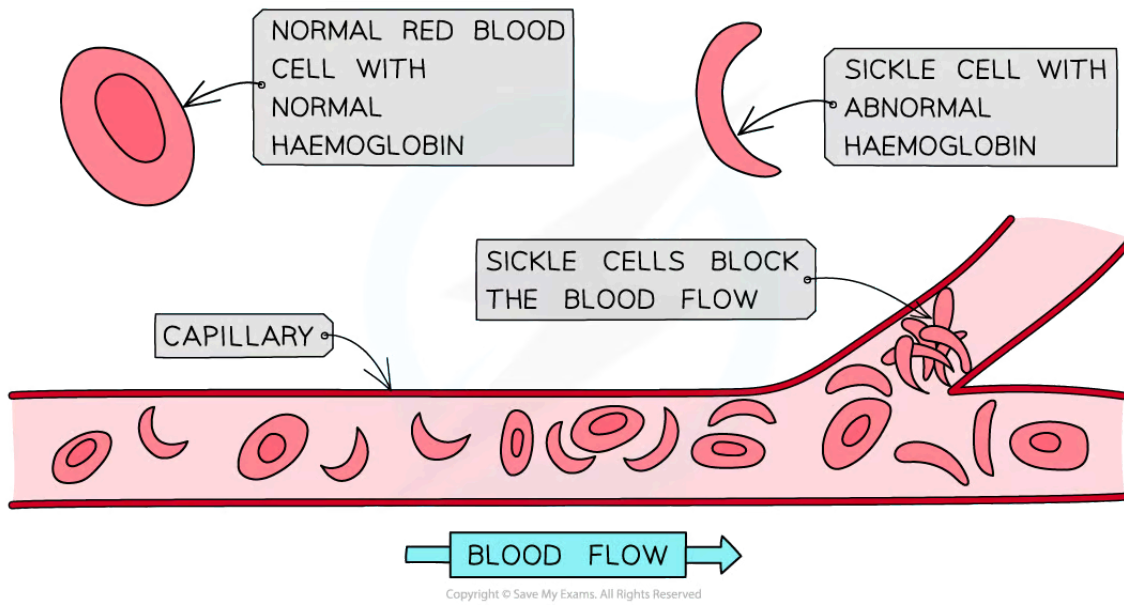

Sickled cells can block the flow of blood through the capillaries, restricting oxygen supply to the tissues

- You will cover more on mutations later in the course; see [this link](#)



Your notes

Mechanism of Transcription (HL)

Directionality of Transcription & Translation

- The synthesis of mRNA occurs in **three stages**:
 - Initiation
 - Elongation
 - Termination
- During **initiation**, RNA polymerase binds near the promoter, causing the **DNA strands to separate** to form an open complex
- During **elongation**, RNA polymerase moves **along the template strand**
 - RNA polymerase adds the 5' end of the free RNA nucleotide to the 3' end of the growing mRNA molecule
 - Elongation occurs in a **5' to 3' direction**, synthesising a single strand of RNA
- Termination occurs when RNA polymerase reaches a **terminator sequence**
 - Which triggers the **detachment of the polymerase enzyme** and **mRNA strand**
- When the mRNA is **translated** at the ribosome it is also read in the **5' to 3' direction**

Direction of transcription diagram

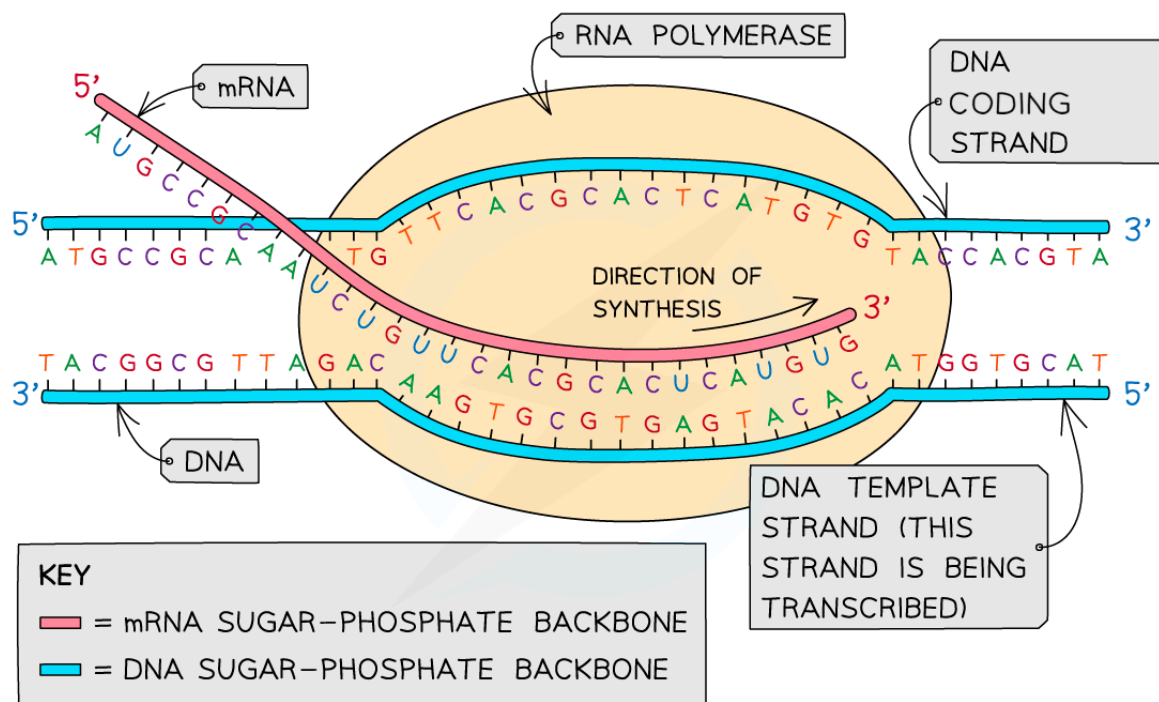

Copyright © Save My Exams. All Rights Reserved

The template strand of the DNA molecule is the one that is transcribed



Your notes

Initiation of Transcription

Gene expression varies in different cells

- Genes are **not expressed equally** in every cell
 - Essential genes** needed for the survival of an organism are **expressed all the time**
 - e.g. Genes for the main enzymes in the **respiratory pathways** or ATP synthase
 - Other genes are **only expressed when needed** and at levels that make specific amounts of protein
 - e.g. The gene for rhodopsin that is only expressed in light-sensitive receptor cells of the eye
- Regulatory mechanisms** exist to ensure the **correct genes are expressed at the correct time**
 - These mechanisms are different between prokaryotes and eukaryotes but both employ **transcription factors** and other proteins that bind to specific sequences in DNA

The function of the promoter

- Only some DNA sequences code for the production of polypeptides, these are called **coding sequences**
- Non-coding sequences produce functional RNA molecules like **transfer RNA (tRNA)** or are involved in the **regulation of gene expression** such as **enhancers, silencers** and **promoters**
- The promoter is a non-coding sequence **located near to a gene**
 - The promoter is not itself transcribed
- The promoter acts as the **binding site for RNA Polymerase** during the **initiation of transcription**
- Binding of RNA Polymerase to the promoter is under the control of various **regulatory proteins**

Regulation of gene expression in eukaryotes

- Eukaryotes regulate gene expression in response to variations in their environment
- Specific proteins bind to DNA to **regulate transcription** and ensure that only the genes required are being expressed in the correct cells, at the correct time and to the right level
 - This is key to how processes of cellular differentiation and development in multicellular organisms are controlled
- General transcription factors** are a type of transcription factors that **bind directly to the promoter** to help initiate transcription
 - This helps RNA polymerase to attach to the promoter and start transcribing the gene
 - In eukaryotes, several general transcription factors are needed for transcription

Transcription factor binding to promoter diagram



Your notes

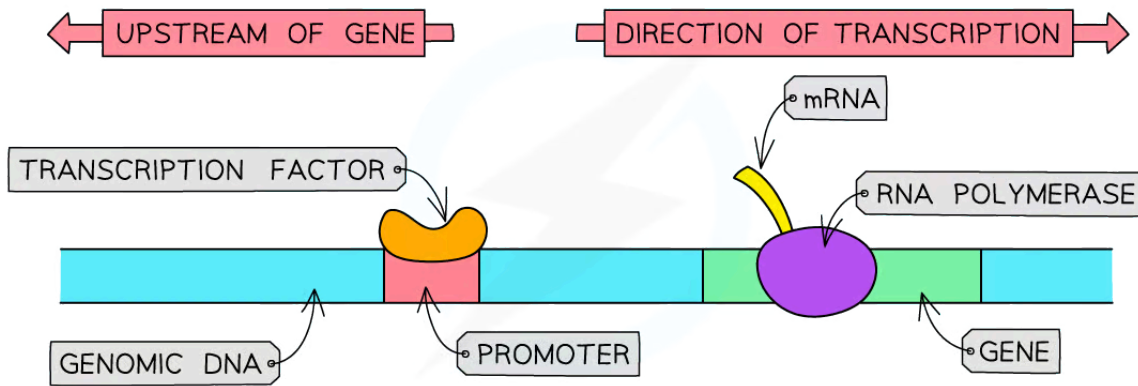

A transcription factor binding to the promoter region of a gene which allows RNA polymerase to bind and for transcription to occur

Non-coding DNA Sequences

- DNA molecules are very long but **only certain regions code** for the production of polypeptides
 - These are called **coding sequences**
- In humans only **1.5% of the genome** contains coding sequences
- The majority of a eukaryotic genome contains non-coding regions of DNA that do not code for polypeptides but **have other important functions**
- Non-coding gene **regulatory sequences** are involved in the control of gene expression by enhancing or suppressing transcription
- Non-coding sequences can produce functional RNA molecules like **transfer RNA** (tRNA) or **ribosomal RNA** (rRNA)
- **Introns** are non-coding sequences of DNA found within genes of eukaryotic organisms
 - Different proteins can be produced from a gene depending on how introns are removed
- **Telomeres** are regions of **repeated nucleotide sequences** at the end of chromosomes that provide protection during cell division
 - The repeated sequence **facilitates binding of an RNA primer** at the end of the chromosome leading to synthesis of an Okazaki fragment
 - Without telomeres, DNA replication could not continue to the end of the DNA molecule and **chromosomes would become shorter** after every cell division
 - Nonetheless, telomeres shorten with age due to oxidative damage within cells
 - **Loss of telomeres** during ageing can be accelerated by smoking, exposure to pollution, obesity, stress and poor diet
 - **Antioxidants** in the diet are claimed to reduce the rate of telomere shortening



Your notes

mRNA splicing diagram



Your notes

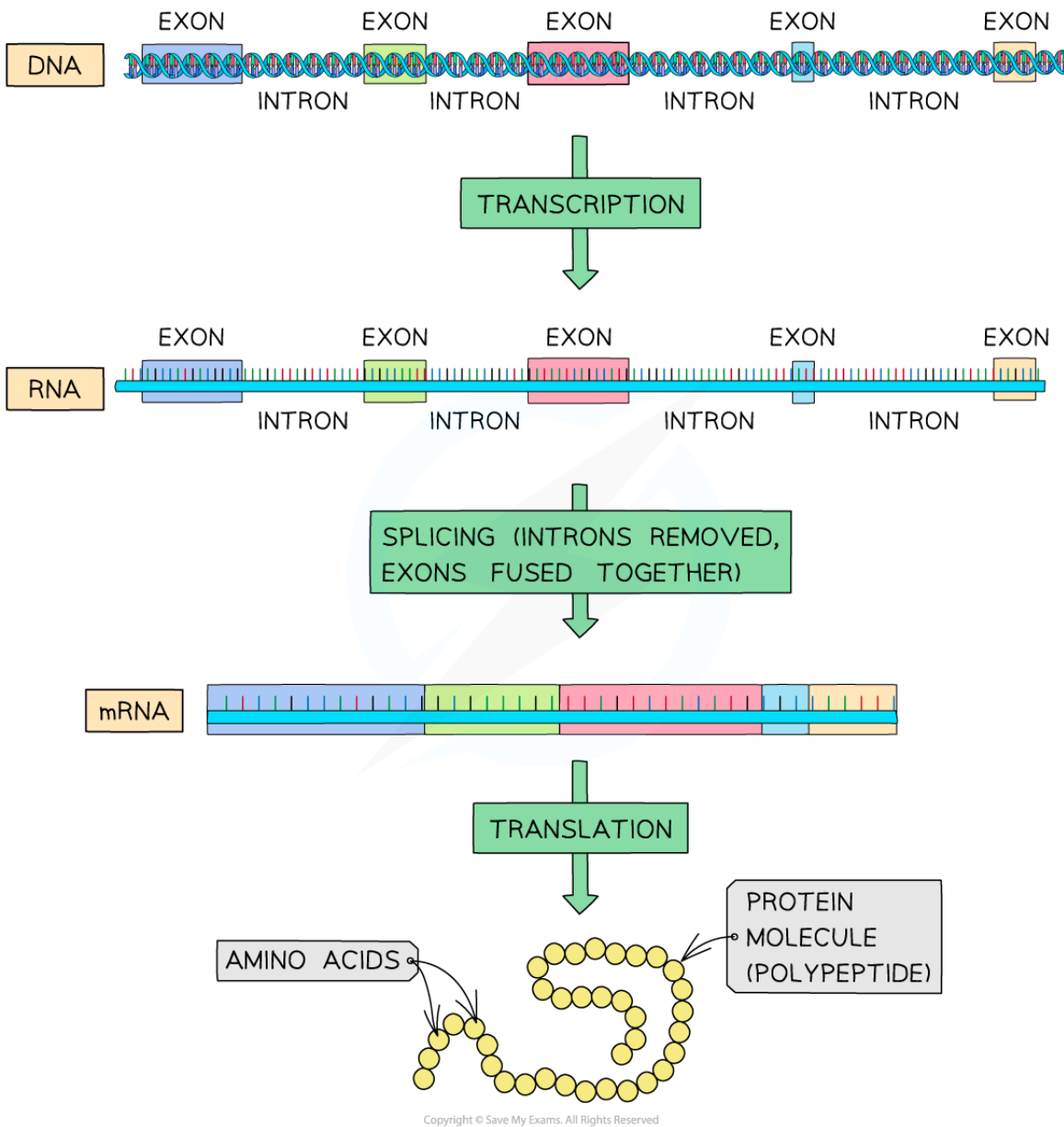

The RNA molecule produced from the transcription of a gene contains introns that must be removed before translation can occur



Your notes

Post-Transcriptional Modification (HL)

Post-Transcriptional Modification

- In all kingdoms of life, **gene expression can be regulated** after an mRNA transcript has been produced
- **Post-transcriptional modification of mRNA**
 - Helps **prevent degradation**
 - mRNA is single stranded and therefore, **inherently unstable**
 - Increases the **efficiency** of protein synthesis
 - In eukaryotes, expands the complexity of the proteome
- Prokaryotic mRNA does not require any significant post-transcriptional modification as **translation can occur immediately** which prevents degradation of the mRNA
- In eukaryotes, transcription and translation occur in **separate parts of the cell**, allowing for significant post-transcriptional modification to occur
- In eukaryotes, the immediate product of an mRNA transcript is called **pre-mRNA** which needs to be modified to form **mature mRNA**
- **Three** post-transcriptional events must occur
 1. A **methylated cap** is added to the 5' end to protect against degradation by exonucleases
 2. A **poly-A tail** (long chain of adenine nucleotides) is added to the 3' end for further protection and to help the transcript exit the nucleus
 3. **Non-coding sequences (introns) are removed** and coding sequences (exons) are joined together



Your notes

Alternative Splicing

- Eukaryotic genes contain both **coding** and **non-coding sequences** of DNA
 - Coding sequences are called **exons**
 - Non-coding sequences are called **introns**
- During transcription **the whole gene is transcribed** including all introns and exons
 - **Introns are not translated** as they do not code for amino acids and **need to be removed**
- Before the pre-mRNA exits the nucleus, **splicing** occurs, during which
 - Introns (non-coding sections) are removed
 - Exons (coding sections) are joined together
 - The resulting **mature mRNA molecule contains only exons** and exits the nucleus before joining a ribosome for translation

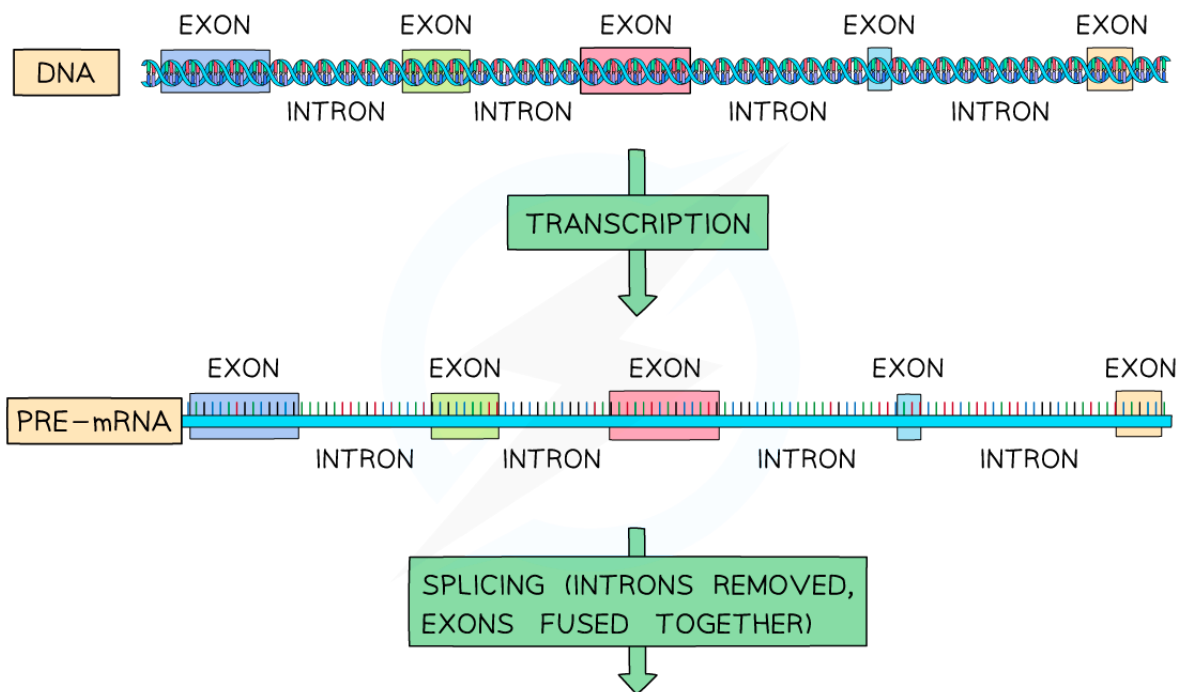

Copyright © Save My Exams. All Rights Reserved



Your notes

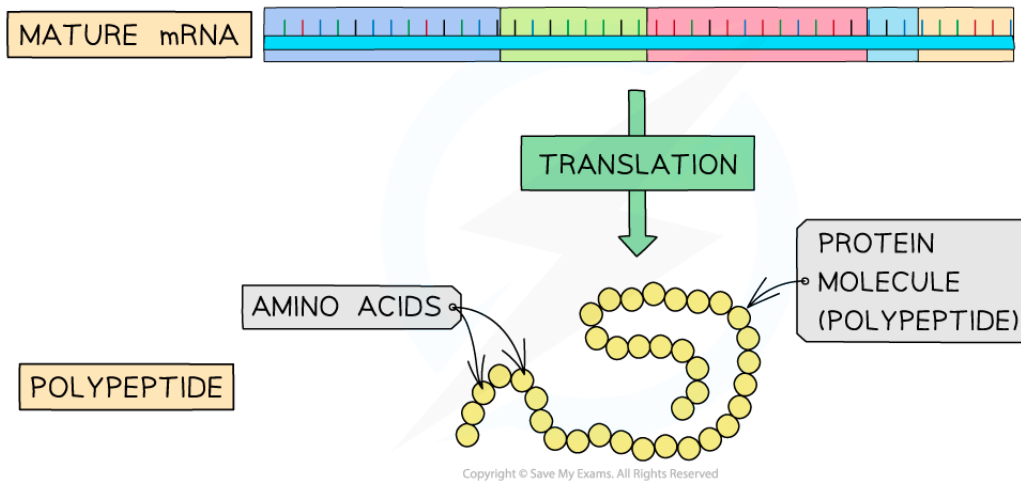

Copyright © Save My Exams. All Rights Reserved

The RNA molecule (known as pre-mRNA) produced from the transcription of a gene contains introns that must be removed (to form mature mRNA) before translation can occur

Alternative splicing

- The exons (coding regions) of genes can be spliced in many different ways to produce **different mature mRNA molecules** through alternative splicing
- A particular exon may or may not be incorporated into the final mature mRNA
- Polypeptides translated from alternatively spliced mRNAs may **differ in their amino acid sequence**, structure and function
- This means that a **single eukaryotic gene can code for multiple proteins**
- This is part of the reason why the **proteome is much bigger than the genome**



Your notes

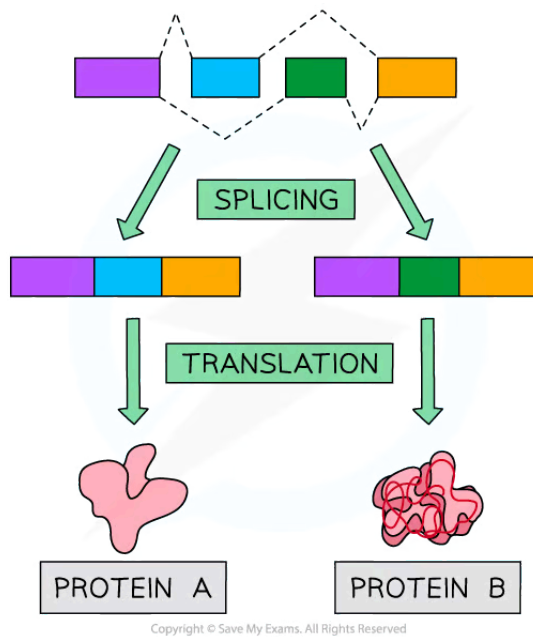

Image showing the alternative splicing of a gene to produce two different proteins

 **Examiner Tip**

It is important you learn the terms pre-mRNA and mRNA, their location and whether they include introns as well as exons. A handy way to distinguish between introns and exons is to remember that **EX**ons are **EX**pressed.



Your notes

Translation & the Proteome (HL)

Initiation of Translation

- During translation, the specific sequence of messenger RNA (**mRNA**) is translated to produce a polypeptide chain consisting of amino acids
 - mRNA is a single stranded, linear, RNA molecule that transfers the information in DNA from the nucleus into the cytoplasm
- Translation is categorised into three stages: **initiation**, **elongation** and **termination**
- Translation occurs in the cytoplasm at complex molecules made of protein and RNA called **ribosomes**
 - Ribosomes have a **two-subunit** (large and small) structure that helps bind mRNA
 - Ribosomes have **three tRNA binding sites** termed “**E**” (exit), “**P**” (peptidyl) and “**A**” (aminoacyl)
 - At the **A site** the mRNA codon joins with the tRNA anticodon
 - At the **P site** the amino acids attached to the tRNA are joined by **peptide bonds**
 - At the **E site** the tRNA exits the ribosome
- Another key molecule in translation is **transfer RNA** (tRNA) that decodes mRNA
 - tRNA molecules are single stranded RNA molecules that **fold** to form a clover-shaped structure
 - The folded structure is held together by **hydrogen bonds** between bases at different points on the strand
 - tRNA molecules are the shortest of the RNA molecules, being only around 80 nucleotides in length
 - There are 20 different types of tRNA molecule, one for each of the amino acids involved in protein synthesis
 - tRNA molecules have a region that binds to a **specific amino acid** as well as a three-nucleotide region called an **anticodon** that is **complementary to the codon on mRNA**
 - The role of tRNA molecule is to carry a specific amino acid to the ribosome



Your notes

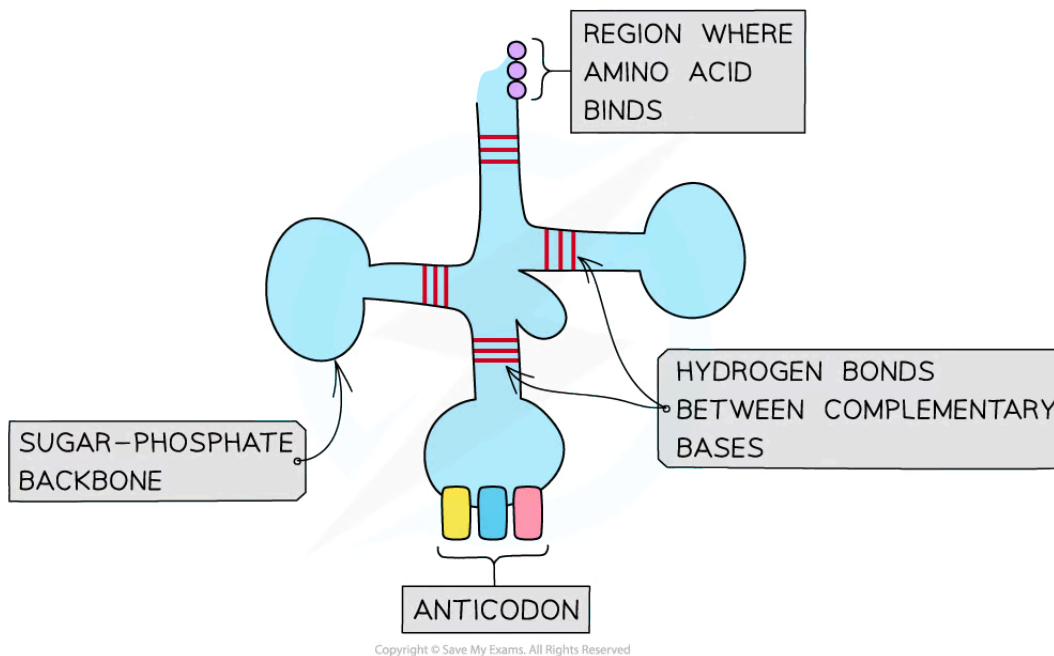

Copyright © Save My Exams. All Rights Reserved

Structure of tRNA

- In eukaryotic cells, the **mRNA molecule leaves the nucleus** through the nuclear pores
- Translation is initiated by the following process
 - A **small ribosomal subunit** attaches to the 5' end of mRNA
 - An **initiator tRNA** molecule carrying the amino acid **methionine** binds to the small ribosomal subunit
 - The initiator tRNA occupies the “P” site on the ribosome
 - The ribosome moves along the mRNA until it locates a start codon (AUG)
 - The **large ribosomal subunit binds to the small subunit**
 - **Elongation** of the polypeptide can begin
- The initiator tRNA currently occupies the “P” site, the next codon on the mRNA signals for the corresponding tRNA to bind at the “A” site
 - The two amino acids (attached to the tRNAs) are **linked with a peptide bond**, forming a dipeptide
- Synthesis of the peptide chain now involves a **repeated cycle of events**
 - In the cytoplasm, free tRNA molecules bind to their corresponding amino acids and transport them to the ribosome
 - The ribosome shifts along the mRNA one codon (three bases) at a time
 - The initiator tRNA in the “P” site moves to the “E” site which **releases** it
 - The tRNA carrying the peptide chain moves from the “A” site to the “P” site
 - The **next mRNA codon** is exposed and a tRNA with the complementary anticodon binds to the unoccupied “A” site whilst its amino acid is linked to the polypeptide chain
- The cyclical process is repeated as **new amino acids are added to the growing chain**



Your notes

Modification of Polypeptides

- Once the primary structure of the polypeptide has been **synthesised during translation** it is often not immediately usable by the cell
 - The polypeptide must be **modified** in order to be transformed into a functional protein
- Some examples of modifications include:
 - Protein folding** into the secondary, tertiary and quaternary structures, including the formation of disulfide bonds in the tertiary and quaternary stages
 - Folding can require **molecular chaperones** that help to prevent incorrect folding
- The formation of **insulin** requires polypeptide modification
 - When insulin is first synthesised it is in the form of an 110 long polypeptide chain called **pre-proinsulin**, which is attached to the wall of the endoplasmic reticulum (ER)
 - It is then modified by an enzyme that **removes a peptide called a signal peptide** from the end, detaching it from the ER and transforming it to **proinsulin**
 - From there the proinsulin **folds and disulfide bonds form** between different sections of the polypeptide
 - The proinsulin is packaged into vesicles at the Golgi apparatus
 - The proinsulin is then **cleaved** (during which a section called the **C peptide** is removed from the middle) resulting in **two chains (A-chain and B-chain)** attached together with two disulfide bonds
 - This is the final, mature form of insulin, ready to be secreted from the cell and used in the body

Recycling of Amino Acids

- Unneeded, damaged, or misfolded proteins** can be **recycled** in the body into usable proteins
- This involves enzymes to break the peptide bonds in these proteins, and **releasing the amino acids to be used in translation to synthesise new proteins**
 - Proteases** are enzymes that break down proteins in this way
 - This process is called **proteolysis**
- The **proteasome** is an organelle found in eukaryotic cells and acts as the **location for proteolysis** in the cell
- By containing the protease enzymes within an organelle it prevents other useful cellular proteins being broken down by mistake
- Proteins identified as being unneeded, damaged, or misfolded are tagged with a chemical called **ubiquitin**, which begins the process of them being broken down in the proteasome
- This process is constantly taking place in the cell and is essential for sustaining a functional proteome