

 **SL IB Physics**
Your notes

Radioactive Decay

Contents

- * Isotopes & Radioactive Decay
- * Background Radiation
- * Alpha, Beta & Gamma Particles
- * Radioactive Decay Equations
- * Activity & Half-Life
- * Applications of Radioactivity
- * Mass Defect & Nuclear Binding Energy
- * Binding Energy per Nucleon Curve



Your notes

Isotopes & Radioactive Decay

Isotopes

- **Elements** are defined by a **fixed** number of **protons** in their atoms
 - For example, all hydrogen atoms have 1 proton, and all carbon atoms have 6 protons
- However, atoms of an element can have **different** numbers of **neutrons**
 - These different versions of elements are called **isotopes**
- An isotope is defined as:

Nuclei that have the same number of protons but different numbers of neutrons
- For example, hydrogen has two isotopes, **deuterium** and **tritium**
 - All three isotopes contain 1 proton, but different numbers of neutrons

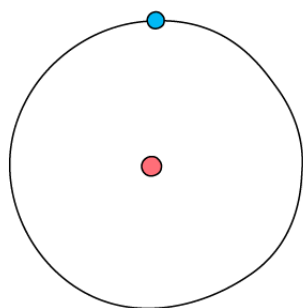
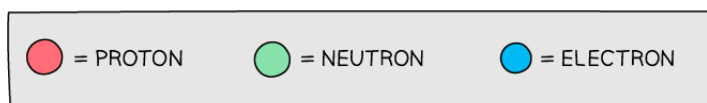

HYDROGEN



(1 PROTON,
0 NEUTRONS)

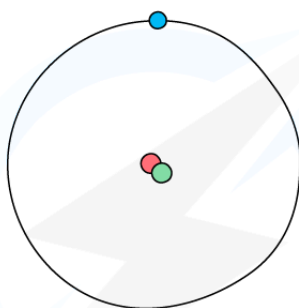

DEUTERIUM



(1 PROTON,
1 NEUTRON)

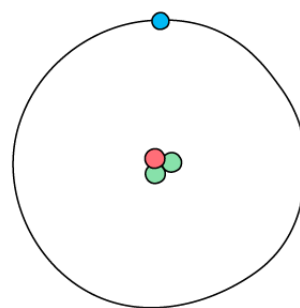

TRITIUM



(1 PROTON,
2 NEUTRONS)

Copyright © Save My Exams. All Rights Reserved

The three atoms shown above are all forms of hydrogen, but they each have different numbers of neutrons

- Since nucleon number A includes the number of protons and neutrons, an isotope of an element will have
 - A **fixed** proton number, Z
 - A **different** nucleon number, A

- Some isotopes have an imbalance of neutrons and protons which makes them **unstable**
 - This means they constantly decay and emit radiation to achieve a more stable form
 - This can happen from anywhere between a few nanoseconds to 100,000 years



Your notes

Isotopic Data

- Isotopic data is defined as:

The relative amounts of different isotopes of an element present within a substance
- The mass of an element is displayed on the periodic table as relative atomic mass
- This takes the masses and abundances of all the naturally occurring isotopes of an element into account

			4.00 He HELIUM 2
14.01 N NITROGEN 7	16.00 O OXYGEN 8	19.00 F FLUORINE 9	20.18 Ne NEON 10
30.97 P PHOSPHORUS 15	32.07 S SULFUR 16	35.45 Cl CHLORINE 17	39.95 Ar ARGON 18

Copyright © Save My Exams. All Rights Reserved

Isotopic data is used to determine the relative atomic masses of elements on the periodic table

- The relative atomic mass of an element can be calculated using the relative abundance values
- The percentage abundance of different isotopes in a sample can be obtained using a mass spectrometer

Table of isotopic data for a sample of oxygen

Isotope	Percentage abundance
^{16}O	99.76
^{17}O	0.04
^{18}O	0.20

Copyright © Save My Exams. All Rights Reserved



Your notes

- For example, a sample of oxygen may contain three isotopes: $^{16}_8\text{O}$, $^{17}_8\text{O}$ and $^{18}_8\text{O}$
- The relative atomic mass of this sample of oxygen can be calculated using:
 $(16 \times 0.9976) + (17 \times 0.0004) + (18 \times 0.002) = 16.0044$
- To two decimal places, the relative atomic mass of the sample of oxygen is 16.00
- A common use of isotopic data is **carbon dating** of archaeological artefacts
 - This involves using the ratio of the amount of stable isotope carbon-12, to the amount of unstable isotope, carbon-14
 - The age of a sample of dead tissue can be determined by comparing the ratio of these isotopes to the ratio in a sample of living tissue



Your notes

Worked example

Which of the following rows shows a pair of nuclei that are isotopes of one another?

		nucleon number	number of neutrons
A.	nucleus 1	39	19
	nucleus 2	35	22
B.	nucleus 1	37	20
	nucleus 2	35	18
C.	nucleus 1	37	18
	nucleus 2	35	20
D.	nucleus 1	35	20
	nucleus 2	35	18

Answer: B

- In Nucleus 1:
 - Nucleon number: 37
 - Neutrons: 20
 - Protons = $37 - 20 = 17$
- In Nucleus 2:
 - Nucleon number: 35
 - Neutrons: 18
 - Protons = $35 - 18 = 17$
- They have the **same number of protons** but different numbers of neutrons hence, they are isotopes of each other



Your notes

Radioactive Decay

- Radioactive decay is defined as:
The spontaneous disintegration of a nucleus to form a more stable nucleus, resulting in the emission of an alpha, beta or gamma particle
- The **random nature** of radioactive decay can be demonstrated by observing the count rate of a Geiger-Muller (GM) tube
 - When a GM tube is placed near a radioactive source, the counts are found to be irregular and cannot be predicted
 - Each count represents a decay of an unstable nucleus
- These fluctuations in count rate on the GM tube provide **evidence** for the **randomness of radioactive decay**



The variation of count rate over time of a sample radioactive gas. The fluctuations show the randomness of radioactive decay

Characteristics of Radioactive Decay

- Radioactive decay is both **spontaneous** and **random**
- A spontaneous process is defined as:

A process which cannot be influenced by environmental factors

- This means radioactive decay cannot be affected by environmental factors such as:
 - Temperature
 - Pressure
 - Chemical conditions
- A random process is defined as:

A process in which the exact time of decay of a nucleus cannot be predicted

- Instead, the nucleus has a constant probability, ie. the same chance, of decaying in a given time
- Therefore, with large numbers of nuclei, it is possible to statistically predict the behavior of the entire group



Your notes



Your notes

Background Radiation

Background Radiation

- Background radiation is defined as:
The ionising radiation present in the environment
- The sources of background radiation can be separated into:
 - Natural sources
 - Artificial sources

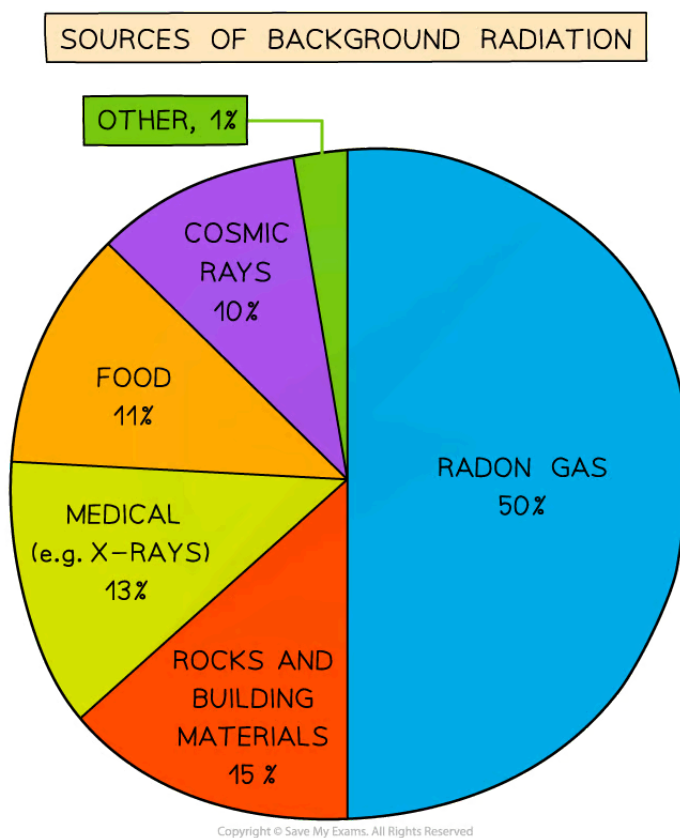

In the UK, radon gas is by far the largest proportion of background radiation, whereas radiation due to nuclear waste and fallout accounts for less than 1%

Natural Sources of Background Radiation

Radon gas from rocks and buildings

- Airborne radon gas comes from rocks in the ground, as well as building materials e.g. stone and brick
- This is due to the presence of radioactive elements, such as uranium, which **occur naturally** in small amounts in all rocks and soils

- Uranium decays into radon gas, which is an alpha emitter
- This is particularly dangerous if inhaled into the lungs in large quantities
- Radon gas is tasteless, colourless and odourless so it can only be detected using a Geiger counter
- Levels of radon gas are generally very low and are not a health concern, but they can vary significantly from place to place
 - For example, in the UK, some areas may contain rocks and soil which emit higher concentrations of radon gas



Your notes

Radon Concentration Map of the UK

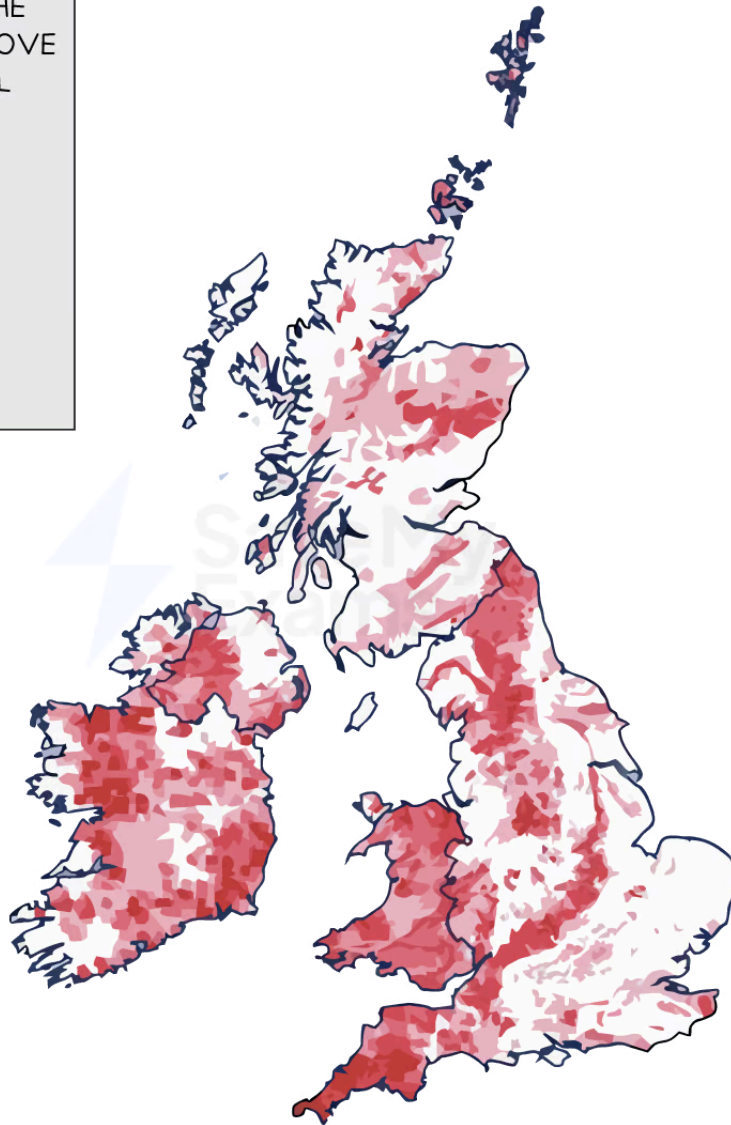
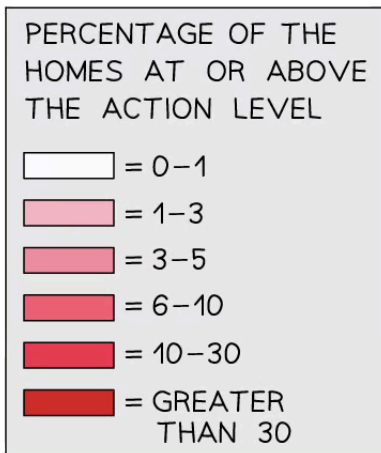

Copyright © Save My Exams. All Rights Reserved



Your notes

Radon gas occurs naturally in all rocks and soils. The concentration of radon gas varies from region to region in the UK. The darker red regions show where higher radon concentrations are more likely to occur

Cosmic rays from space

- The Sun emits an enormous number of subatomic particles (predominantly protons and alpha particles) every second
- Some of these enter the Earth's atmosphere at high speeds
- When they collide with molecules in the air, this leads to the production of gamma radiation
- Other sources of cosmic rays are supernovae and other high-energy cosmic events

Carbon-14 in biological material

- All organic matter contains a tiny amount of carbon-14
- Living plants and animals constantly replace the supply of carbon in their systems hence the amount of carbon-14 in the system stays almost constant

Radioactive material in food and drink

- Naturally occurring radioactive elements can get into food and water since they are in contact with rocks and soil containing these elements
- Some foods contain higher amounts such as potassium-40 in bananas
- However, the amount of radioactive material is minuscule and is not a cause for concern

Artificial Sources of Background Radiation

Nuclear medicine

- In medical settings, nuclear radiation is utilised all the time
- For example, X-rays, CT scans, radioactive tracers, and radiation therapy all use radiation

Nuclear waste

- While nuclear waste itself does not contribute much to background radiation, it can be dangerous for the people handling it

Nuclear fallout from nuclear weapons

- Fallout is the residue radioactive material that is thrown into the air after a nuclear explosion, such as the bomb that exploded at Hiroshima
- While the amount of fallout in the environment is presently very low, it would increase significantly in areas where nuclear weapons are tested

Nuclear accidents

- Nuclear accidents, such as the incident at Chernobyl, contribute a large dose of radiation to the environment
- While these accidents are now extremely rare, they can be catastrophic and render areas devastated for centuries

Accounting for Background Radiation

- Background radiation must be accounted for when taking readings in a laboratory



Your notes

- This can be done by taking readings with no radioactive source present and then subtracting this from readings with the source present
- This is known as the **corrected count rate**

Measuring Background Count Rate

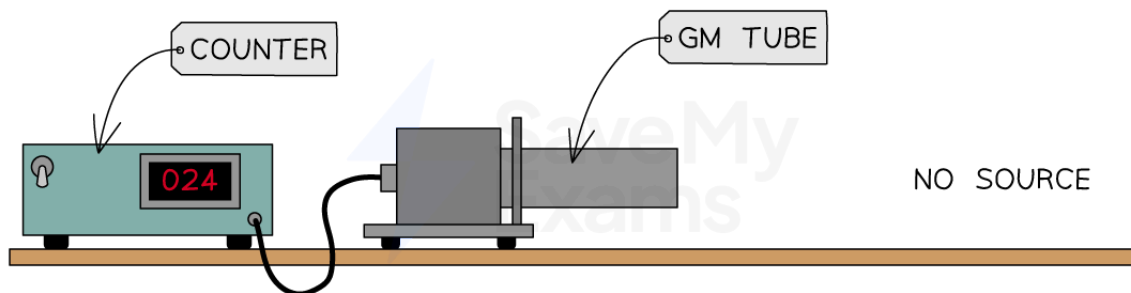

Copyright © Save My Exams. All Rights Reserved

The background count rate can be measured using a Geiger-Müller (GM) tube with no source present

- For example, if a Geiger counter records 24 counts in 1 minute when no source is present, the background radiation count rate would be:
 - 24 counts per **minute** (cpm)
 - $24/60 = 0.4$ counts per **second** (cps)

Measuring Corrected Count Rate of a Source

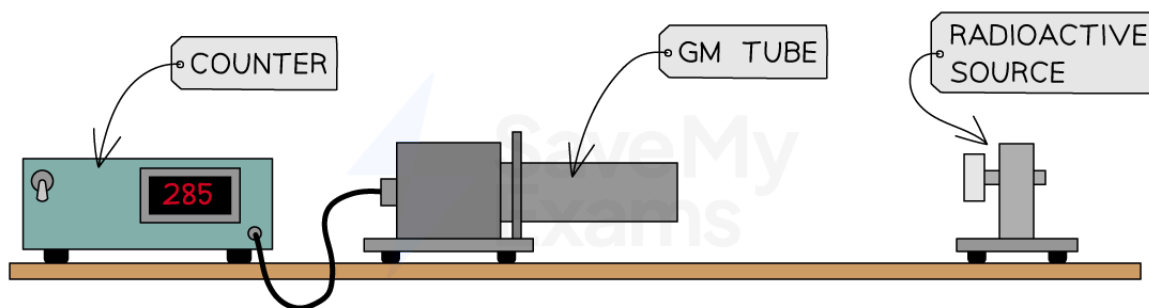

Copyright © Save My Exams. All Rights Reserved

The corrected count rate can be determined by measuring the count rate of a source and subtracting the background count rate

- Then, if the Geiger counter records, for example, 285 counts in 1 minute when a source is present, the corrected count rate would be:
 - $285 - 24 = 261$ counts per **minute** (cpm)
 - $261/60 = 4.35$ counts per **second** (cps)
- When measuring count rates, the **accuracy** of results can be improved by:
 - Repeating readings and taking averages
 - Taking readings over a long period of time



Your notes

Worked example

A student is using a Geiger counter to measure the counts per minute at different distances from a source of radiation.

Their results and a graph of the results are shown below.

RESULTS TABLE

Distance from source (m)	Counts per minute
0.2	180
0.4	67
0.6	29
0.8	17
1.0	15
1.2	15
1.4	15

GRAPH

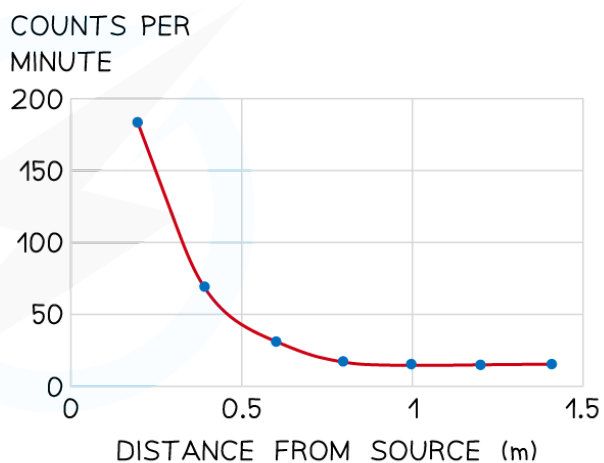

Copyright © Save My Exams. All Rights Reserved

Determine the background radiation count.

Answer:

- The background radiation is the amount of radiation detected in the absence of a radioactive source
- When the source is moved back far enough, all radiation is absorbed by the air before reaching the Geiger-counter
- This is shown at 1.0 m where the count rate becomes constant
- Therefore, the readings after 1.0 m are due to background radiation only
- Background radiation count = **15 counts per minute**



Your notes

Alpha, Beta & Gamma Particles

Alpha, Beta & Gamma Decay

- Some isotopes of elements are **unstable**
 - This can happen when a nucleus has an **imbalance** of protons and neutrons or too much **energy**
- To become more stable, a nucleus can emit particles or radiation by the process of **radioactive decay**
- The **three** main types of radioactive particle or radiation are:
 - Alpha particles
 - Beta particles
 - Gamma radiation

Alpha Particles

- An alpha (α) particle is a high-energy helium nucleus
 - It contains **2 protons** and **2 neutrons**
 - It has a mass of **4u** and a charge of **+2e**
- The nuclear notation for an alpha particle is:



Copyright © Save My Exams. All Rights Reserved

Nuclear notation for an alpha particle (a helium nucleus)

- Alpha particles are usually emitted by large, unstable nuclei with too many nucleons (protons and neutrons)
- When an unstable nucleus decays, its composition changes
- When an alpha particle is emitted from a nucleus:
 - The nucleus loses 2 protons: **proton number decreases by 2**
 - The nucleus loses 4 nucleons: **nucleon number decreases by 4**
- As there is a change in proton number, the parent nucleus is a **different element** to the daughter nucleus



Your notes

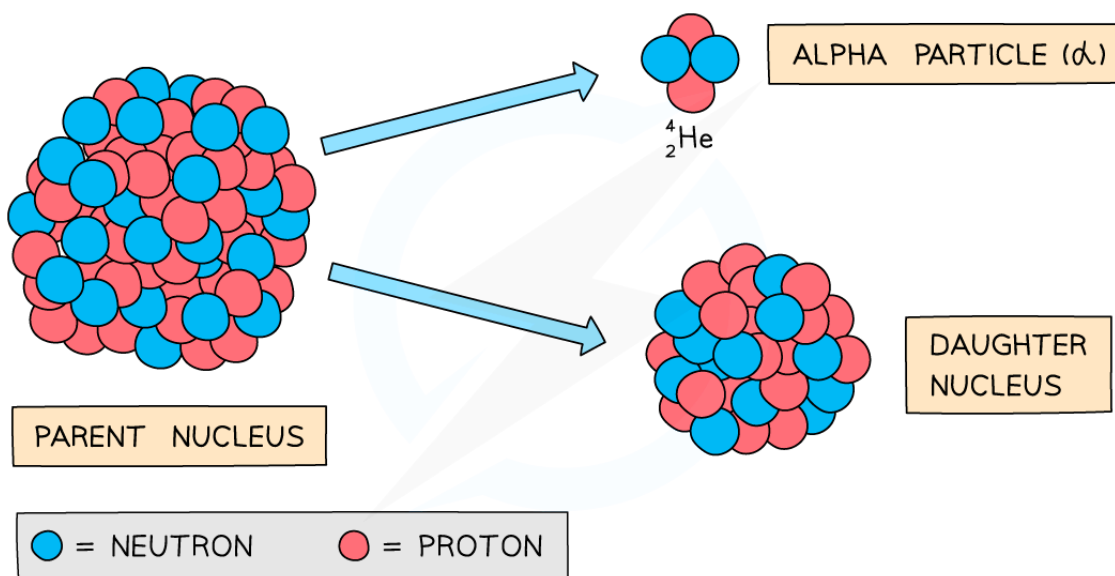

Copyright © Save My Exams. All Rights Reserved

During alpha decay, a parent nucleus becomes a daughter nucleus by emitting an alpha particle (helium nucleus)

Beta-Minus Decay

- A beta-minus (β^-) particle is a high-energy **electron**
 - It has a mass of **0.0005u** and a charge of **-1e**
- The nuclear notation for a beta-minus particle is:



Copyright © Save My Exams. All Rights Reserved

- Beta-minus particles are usually emitted by unstable nuclei with too many **neutrons**
- Beta-minus decay is when a **neutron** turns into a **proton** and emits an **electron** and an **anti-electron neutrino**
- Electrons have a proton number of -1, so overall:
 - The **proton number increases by 1**
 - The **nucleon number remains the same**

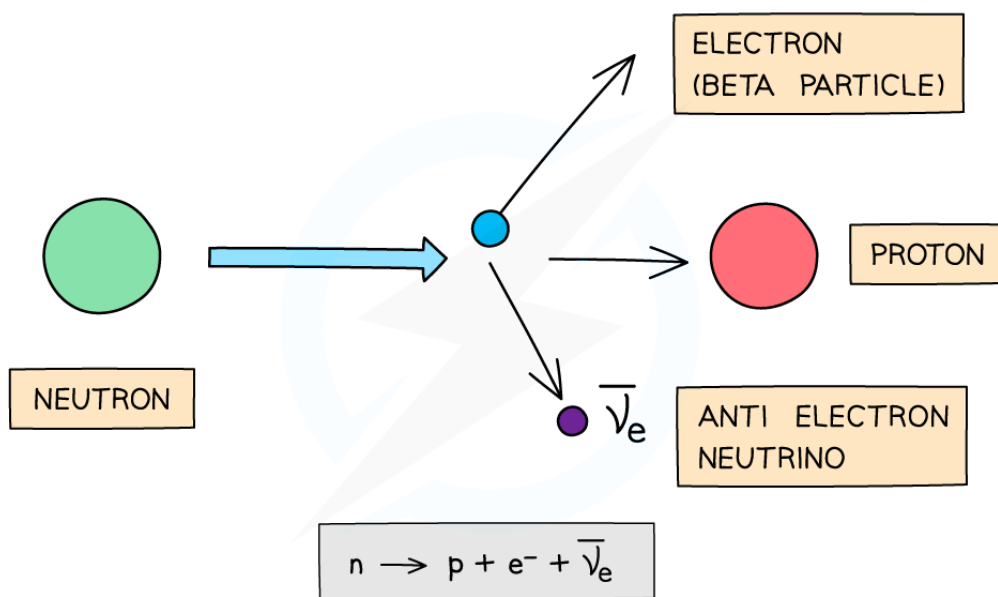

Copyright © Save My Exams. All Rights Reserved

Beta-minus decay often happens in unstable nuclei that have too many neutrons. The nucleon number stays the same, but the proton number increases by one

Beta-Plus Decay

- A beta-plus (β^+) particle is a high-energy **positron**
 - It is the antimatter particle of the electron
 - It has a mass of **0.0005u** and a **charge of +1e**
- The nuclear notation for a beta-minus particle is:

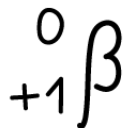

BETA PLUS

- Beta-plus particles are usually emitted by unstable nuclei with too many **protons**
- Beta-plus decay is when a **proton** turns into a **neutron** and emits a **positron** and an **electron neutrino**
- Positrons have a proton number of +1, so overall:
 - The **proton number decreases by 1**
 - The **nucleon number remains the same**

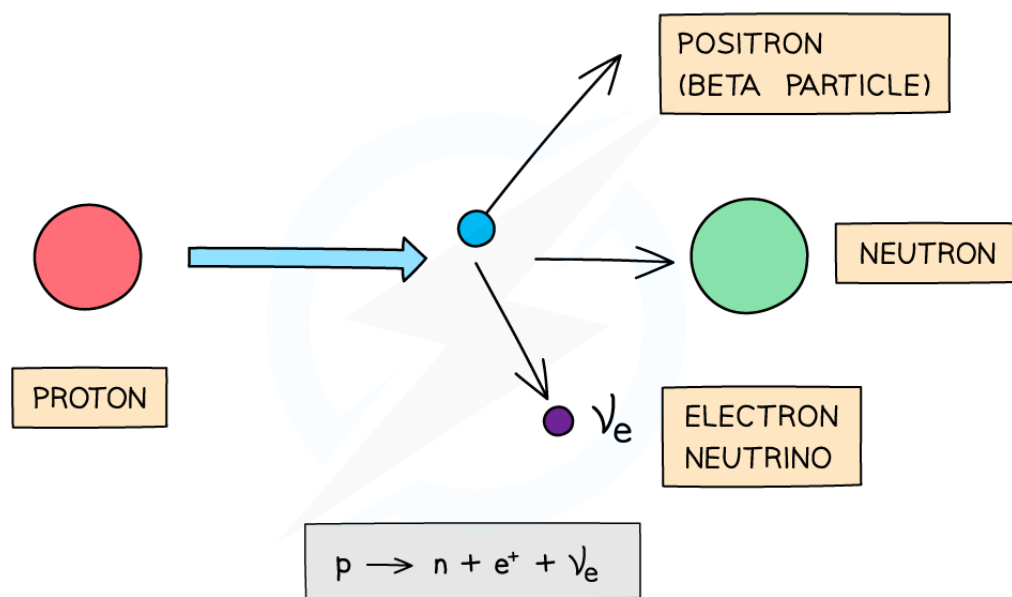

Copyright © Save My Exams. All Rights Reserved

Beta-plus decay often happens in unstable nuclei that have too many protons. The nucleon number stays the same, but the proton number decreases by one

Gamma Radiation

- Gamma (γ) rays are a type of high-energy electromagnetic radiation
- They are emitted by nuclei that need to lose some energy
- The nuclear notation for gamma radiation is:



Copyright © Save My Exams. All Rights Reserved

Nuclear notation for gamma rays

- Gamma particles are **photons**, so they have a proton number of 0, so overall:
 - The **proton number remains the same**
 - The **nucleon number remains the same**



Your notes

Worked example

The radioactive nucleus ${}_{86}^{222}\text{Rn}$ undergoes alpha decay into a daughter nucleus Po.

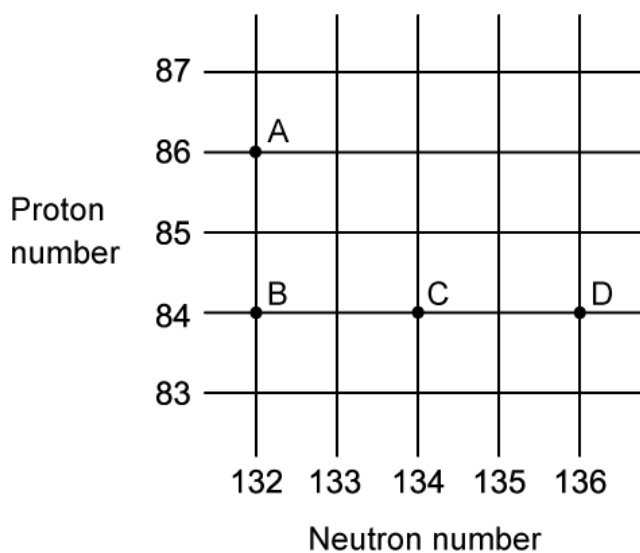

- (a) Which letter in the diagram represents the daughter product?
 (b) What is the nucleon number and proton number of Po?

(a) Answer: C

- The number of neutrons in ${}_{86}^{222}\text{Rn}$ is $222 - 86 = 136$
- In alpha decay, the parent nucleus loses a helium nucleus (2 protons, 2 neutrons)
 - Proton number: 86 decreases to 84
 - Neutron number: 136 decreases to 134



Your notes

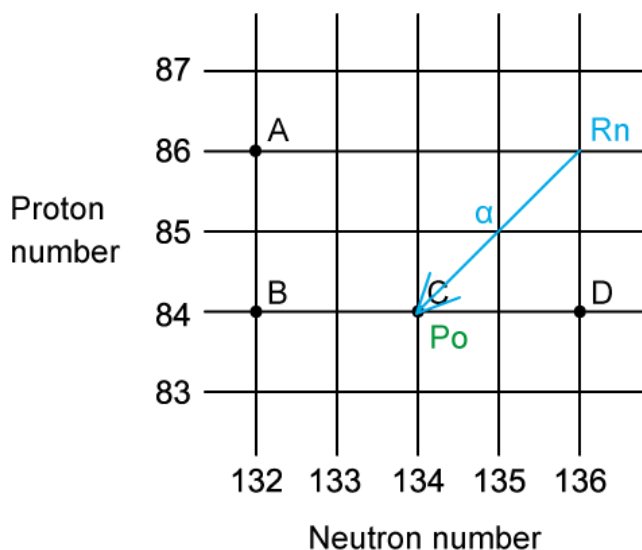

- Therefore, the correct answer is C

(b)

- The equation for alpha decay is as follows:

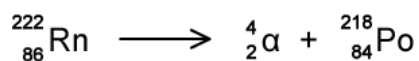
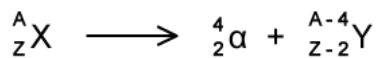

- Hence the daughter nucleus Po has
 - Nucleon number = $222 - 4 = 218$
 - Proton number = $86 - 2 = 84$



Your notes

Worked example

A radioactive substance with a nucleon number of 212 and a proton number of 82 decays by β -plus emission into a daughter product which further decays by β -plus emission into a granddaughter product.

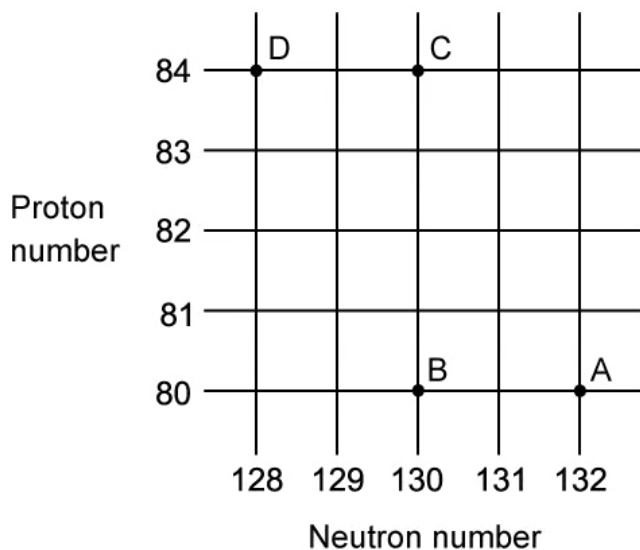

Which letter in the diagram represents the granddaughter product?

Answer: A

- The number of neutrons in the parent nucleus is $212 - 82 = 130$
- In beta-plus decay, a proton turns into a neutron
 - Proton number: 82 decreases to 80
 - Neutron number: 130 increases to 132



Your notes

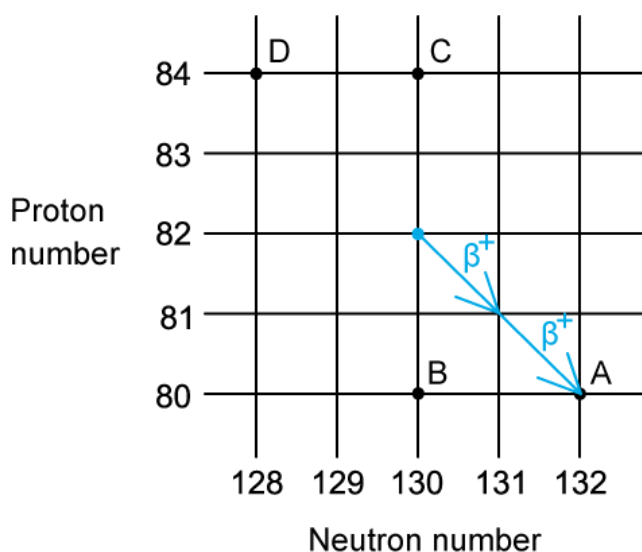

- Therefore, the correct answer is **A**

Examiner Tip

Remember to avoid the common mistake of confusing the number of neutrons with the nucleon number. In alpha decay, the nucleon (protons and neutrons) number decreases by 4 but the number of neutrons only decreases by 2.

To remember which type of beta emission occurs, try to think of beta 'plus' as the 'proton' that turns into the neutron (plus an electron neutrino)



Your notes

Properties of Alpha, Beta & Gamma

- Alpha, beta and gamma radiation can be characterised by
 - Ionising ability** - a measure of the amount of ionisation caused when nuclear radiation passes through a material
 - Penetrating power** - a measure of the distance nuclear radiation will travel before losing all its energy
- The greater the ionising ability of a type of radiation, the lower its penetrating power, and vice versa

Ionising ability

- If any type of radiation collides with an atom, it can knock out electrons, ionising **the atom**
- This can cause chemical changes in materials and damage to living cells
- The ionising ability of radiation can be quantified by the number of ion pairs it produces per cm of air
 - Highly ionising** radiation may produce 10^4 ion pairs per cm of air
 - Weakly ionising** radiation may produce 1 ion pair per cm of air

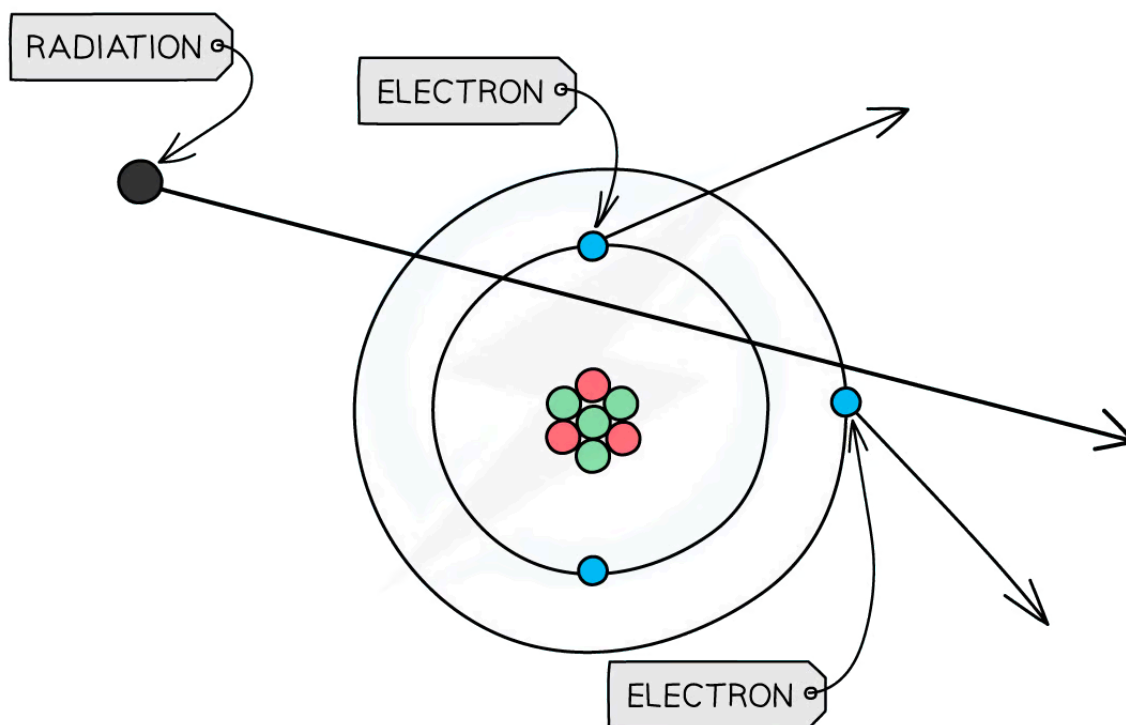

Copyright © Save My Exams. All Rights Reserved

When radiation passes close to atoms, it can knock out electrons, ionising the atom

Penetrating power

- The distance radiation can travel before losing most, or all, of its energy, is described by its **penetrating power**
- The **lower** the penetrating power of a type of radiation, the **shorter** its range in air



Your notes

- Highly ionising radiation has a **low** penetrating power
- Weakly ionising radiation has a **high** penetrating power

Deflection in Electric and Magnetic Fields

- When a charged particle enters an **electric field** it will undergo a deflection
 - Alpha particles are deflected towards the **negative** plate
 - Beta particles are deflected towards the **positive** plate
 - Gamma radiation is **not** deflected and travels straight through between the plates

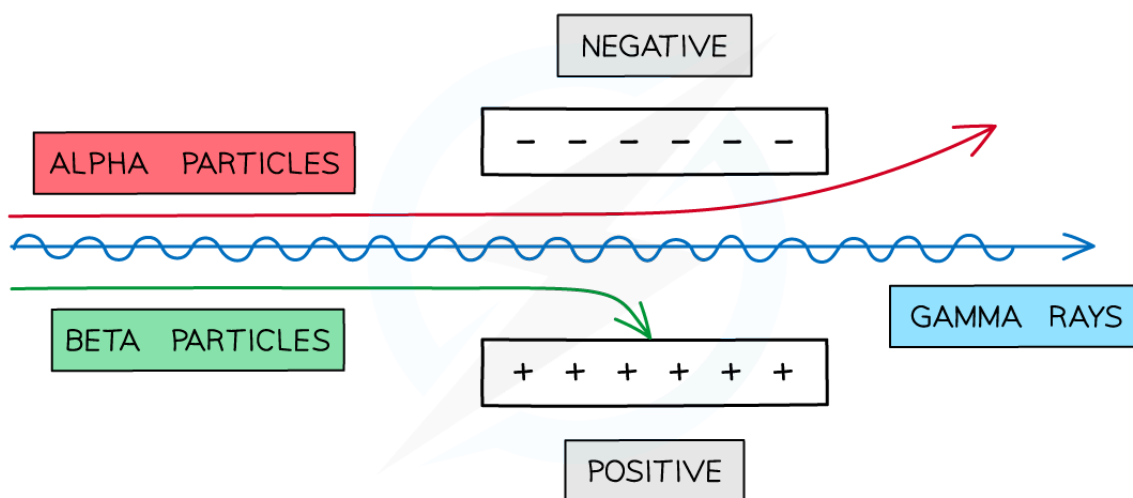

Copyright © Save My Exams. All Rights Reserved

Alpha and beta particles are deflected by an electric field whereas gamma rays are not

- When a charged particle moves in a **magnetic field**, it will also undergo a deflection
- Faster-moving particles move in larger circular paths according to the equation:

$$Bqv = \frac{mv^2}{r} \Rightarrow r = \frac{mv}{Bq}$$

- The larger the circular path, the greater the deflection
- The amount of deflection of a particle depends on:
 - The speed of the particle, v
 - The mass of the particle, m
 - The charge on the particle, q

Comparing Alpha, Beta & Gamma

- The ionising abilities and penetrating powers of alpha, beta and gamma can be investigated by
 - Measuring the count rate of a radioactive source using a Geiger counter
 - Placing different materials between the source and the detector
 - Measuring the count rate again to see if the material causes a significant reduction

- Alpha particles can be stopped by a single **sheet of paper**
- Beta particles can be stopped by a few millimetres of **aluminium foil**
- The intensity of gamma radiation can be reduced by several **metres of concrete** or several **centimetres of lead**

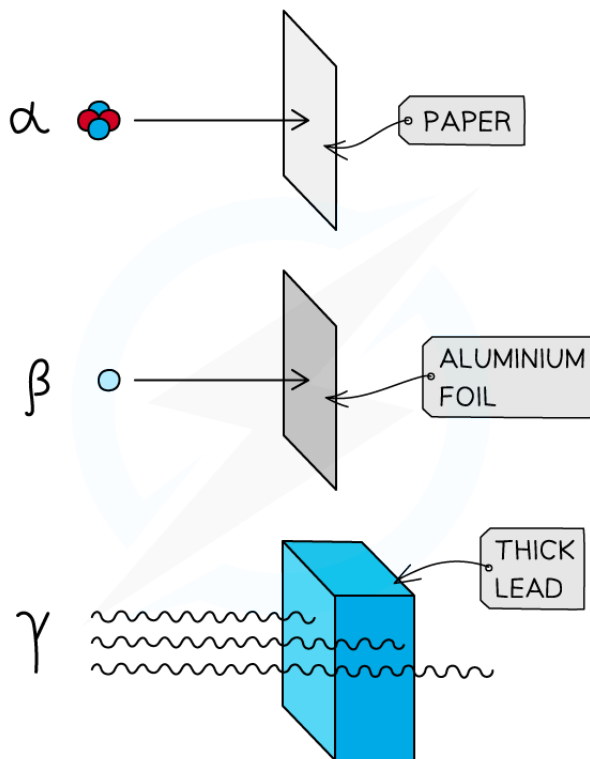

Copyright © Save My Exams. All Rights Reserved

Alpha particles are highly ionising and easily absorbed by atoms whereas gamma radiation is highly penetrating and requires very thick lead to reduce its intensity

- The properties of the different types of radiation are summarised in the table below:

Comparison of alpha, beta and gamma radiation

Radiation	Range in air	Ionising	Penetrating	Absorbed by:
Alpha	3–7 cm	Highly	Weakly	Paper
Beta	20 cm – 3 m	Moderately	Moderately	Aluminium foil \approx 3mm
Gamma	Infinite; follows an inverse square law	Weakly	Highly	Thick lead or concrete

Copyright © Save My Exams. All Rights Reserved



Your notes

Properties of Alpha Radiation

- Alpha is the **most** ionising type of radiation
 - This is due to it having the highest charge of $+2e$
 - This means it produces the greatest number of ion pairs per cm in air
 - This also means it can do more damage to cells than the other types of radiation
- Alpha is the **least** penetrating type of radiation
 - This means it travels the shortest distance in air before being absorbed
 - Alpha particles have a range of around 3–7 cm in air
- Alpha particles can be deflected **slightly** in strong electric and magnetic fields
 - Alpha particles have the highest charge, but also the greatest mass, so their high momentum means they **deflect less** than a beta particle (in a given field)

Properties of Beta Radiation

- Beta is a **moderately** ionising type of radiation
 - This is due to it having a charge of $\pm 1e$
 - This means it can do some slight damage to cells (less than alpha but more than gamma)
- Beta is a **moderately** penetrating type of radiation
 - Beta particles have a range of around 20 cm – 3 m in air, depending on their energy
- Beta particles can be deflected through **large angles** by electric and magnetic fields
 - Beta particles typically travel at much greater speeds than alpha particles, but have much less mass, so they **deflect significantly more** than an alpha particle (in a given field)

Properties of Gamma Radiation

- Gamma is the **least** ionising type of radiation
 - This is because it is an electromagnetic wave with no charge
 - This means it produces the least number of ion pairs per cm in air
 - It can still cause damage to cells, but not as much as alpha or beta radiation. This is why it is used for cancer radiotherapy
- Gamma is the **most** penetrating type of radiation
 - This means it travels the furthest distance in air before being absorbed
 - Gamma radiation has an infinite range and follows an **inverse square law**
- Gamma rays are **not deflected** in magnetic and electric fields as they are electrically neutral
 - However, they can transfer their energy to atomic electrons which can be deflected



Your notes

Worked example

Three successive radioactive decays are shown in the diagram below. Each decay results in a particle being emitted.

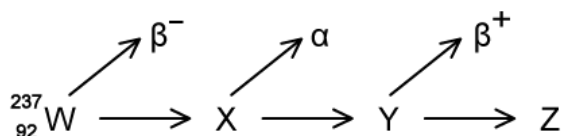

The first decay results in the emission of a beta-minus particle.

The second decay results in the emission of an alpha particle.

The third decay results in the emission of a beta-plus particle.

What is nuclide Z?

- A. ${}^{237}_{90}\text{Z}$ B. ${}^{233}_{92}\text{Z}$ C. ${}^{237}_{89}\text{Z}$ D. ${}^{233}_{90}\text{Z}$

Answer: D

Step 1: Write the equation for the β^- decay

- A β^- particle is an electron
- The nucleon number stays the same
- The proton number increases by 1

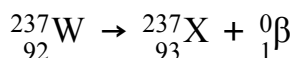

Step 2: Write the equation for the α decay

- An α particle is a helium nucleus
- The nucleon number reduces by 4
- The proton number reduces by 2

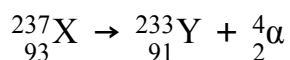

Step 3: Write the equation for the β^+ decay

- A β^+ particle is a positron
- The nucleon number stays the same
- The proton number reduces by 1

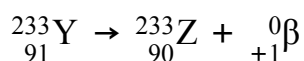

Step 4: Determine the final nucleon Z

- The final nucleon, Z will be:



Your notes



Your notes

Radioactive Decay Equations

Radioactive Decay Equations

- There are four reasons why a nucleus might become unstable, and these determine which decay mode will occur
 - Too many neutrons = beta-minus emission
 - Too many protons = beta-plus emission or electron capture
 - Too many nucleons = alpha emission
 - Too much energy = gamma emission

If there are too many neutrons...

- Beta-minus** (β^-) emission occurs
- One of the **neutrons** in the nucleus changes into a **proton** and a β^- particle (an electron) and antineutrino is released
- The nucleon number is constant
 - The neutron number (N) decreases by 1
 - The proton number (Z) increases by 1
- The general decay equation for β^- emission is:

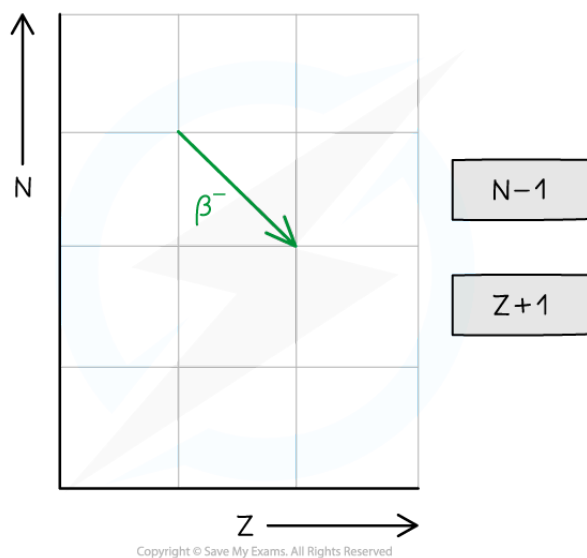
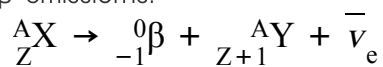

Copyright © Save My Exams. All Rights Reserved

Representing beta-minus decay graphically

If there are too many protons...

- Beta-plus** (β^+) emission or **electron capture** occurs
- In beta-plus decay:



Your notes

- A **proton** changes into a **neutron** and a β^+ particle (a positron) and neutrino are released
- In electron capture:
 - An orbiting electron is taken in by the nucleus and combined with a proton causing the formation of a neutron and neutrino
- In both types of decay, the nucleon number stays constant
 - The neutron number (N) increases by 1
 - The proton number (Z) decreases by 1
- The general decay equation for **β^+ emission** is:

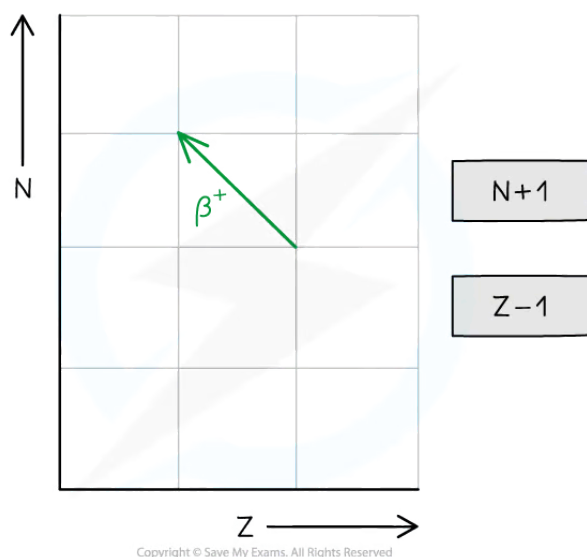
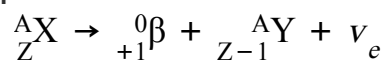

Copyright © Save My Exams. All Rights Reserved

Representing beta-plus decay graphically

- The decay equation for **electron capture** is:

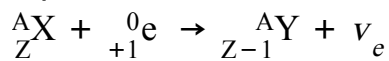

If there are too many nucleons...

- **Alpha** (α) emission occurs
- An α particle is a helium nucleus
- The nucleon number decreases by 4 and the proton number decreases by 2
 - The neutron number (N) decreases by 2
 - The proton number (Z) decreases by 2
- The general decay equation for α emission is:

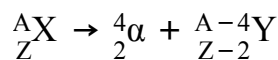

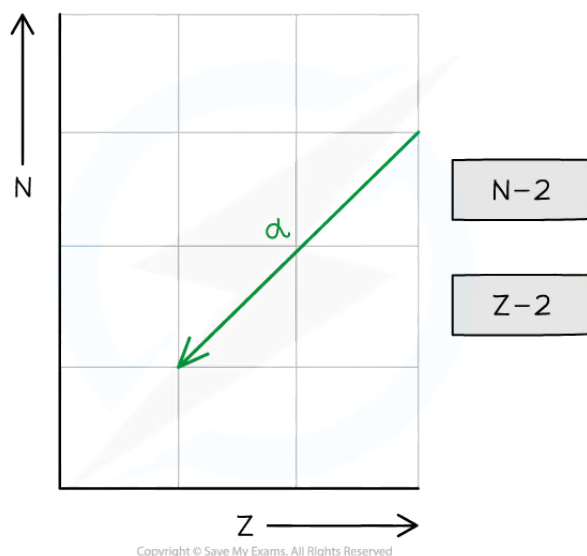

Representing alpha decay graphically

If there is too much energy...

- **Gamma** (γ) emission occurs
- A gamma particle is a high-energy electromagnetic radiation
- This usually occurs after a different type of decay, such as alpha or beta decay
- This is because the nucleus becomes excited and has excess energy

Representing Nuclear Processes Graphically

- In summary, alpha decay, beta decay and electron capture can be represented on an N-Z graph as follows:

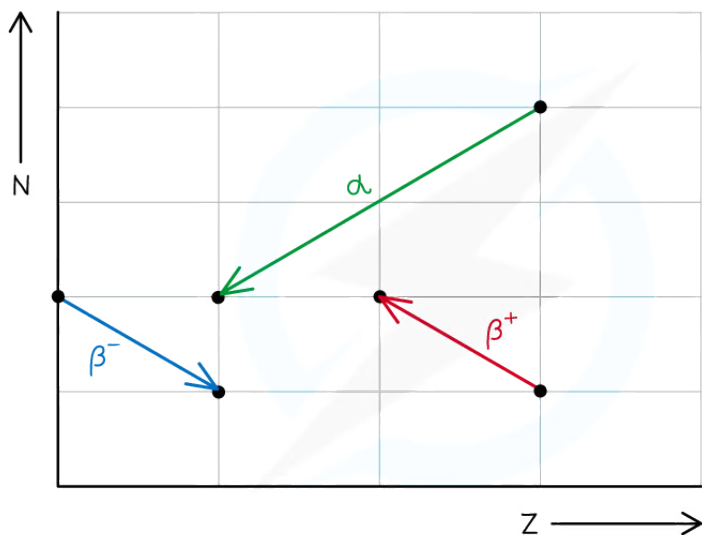

Copyright © Save My Exams. All Rights Reserved

α	
N-2	Z-2

β^-	
N-1	Z+1

β^+	
N+1	Z-1

 Your notes

Representing nuclear processes graphically



Worked example

A nucleus with 84 protons and 126 neutrons undergoes alpha decay. It forms lead, which has the element symbol Pb.

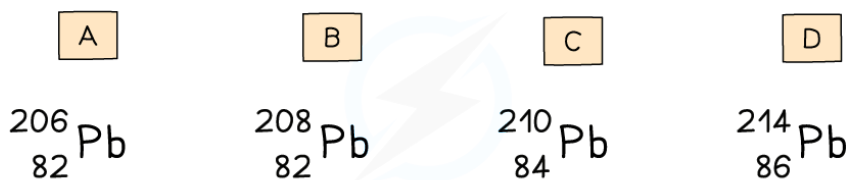

Copyright © Save My Exams. All Rights Reserved

Which of the isotopes of lead pictured is the correct one formed during the decay?

Answer: A

Step 1: Calculate the mass number of the original nucleus

- The mass number is equal to the number of protons plus the number of neutrons
- The original nucleus has 84 protons and 126 neutrons

$$84 + 126 = 210$$

- The mass number of the original nucleus is 210

Step 2: Calculate the new atomic number

- The alpha particle emitted is made of two protons and two neutrons
- Protons have an atomic number of 1, and neutrons have an atomic number of 0
- Removing two protons and two neutrons will reduce the atomic number by 2

$$84 - 2 = 82$$

- The new nucleus has an atomic number of **82**

Step 3: Calculate the new mass number

- Protons and neutrons both have a mass number of 1
- Removing two protons and two neutrons will reduce the mass number by 4

$$210 - 4 = 206$$

- The new nucleus has a mass number of **206**



Worked example

Plutonium-239 is a radioactive isotope that contains 94 protons and emits α particles to form a radioactive isotope of uranium. This isotope of uranium emits α particles to form an isotope of thorium which is also radioactive.

Write two equations to represent the decay of plutonium-239 and the subsequent decay of uranium.

Answer:

Step 1: Write down the general equation of alpha decay

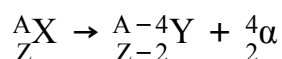

Step 2: Write down the decay equation of plutonium into uranium

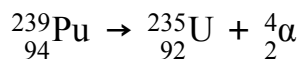

Step 3: Write down the decay equation of uranium into thorium

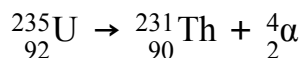

Neutrinos & Antineutrinos

- An electron neutrino is a type of subatomic particle with no charge and negligible mass which is also emitted from the nucleus
- The anti-neutrino is the antiparticle of a neutrino
 - Electron anti-neutrinos are produced during β^- decay
 - Electron neutrinos are produced during β^+ decay

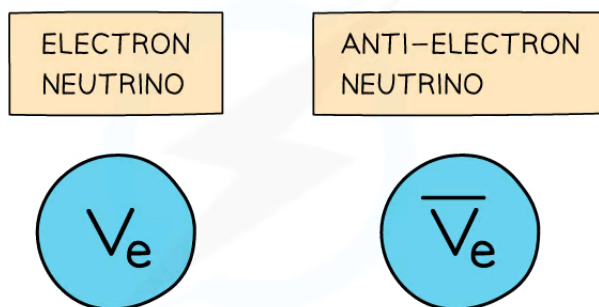

Copyright © Save My Exams. All Rights Reserved



Your notes

Activity & Half-Life

Activity & Half-Life

- The **activity** of a radioactive sample is defined as:
The number of nuclei which decay in a given time
- Activity is measured in **becquerels** (Bq)
 - One becquerel is equivalent to a nucleus decaying every second
- It is impossible to know when a particular unstable nucleus will decay
- But the **rate** at which the activity of a sample decreases can be predicted
 - This is known as the **half-life**
- Half-life is defined as:
The time taken for half the undecayed nuclei to decay or the activity of a source to decay by half
- In other words, the time it takes for the activity of a sample to fall to half its original level
- Different isotopes have different half-lives and these can vary from a fraction of a second to billions of years in length

Using Half-life

- Scientists can measure the half-lives of different isotopes accurately:
- Uranium-235 has a half-life of 704 million years
 - This means it would take 704 million years for the activity of a uranium-235 sample to decrease to half its original amount
- Carbon-14 has a half-life of 5700 years
 - So after 5700 years, there would be 50% of the original amount of carbon-14 remaining
 - After two half-lives, or 11 400 years, there would be just 25% of the carbon-14 remaining
- With each half-life, the amount remaining **decreases by half**

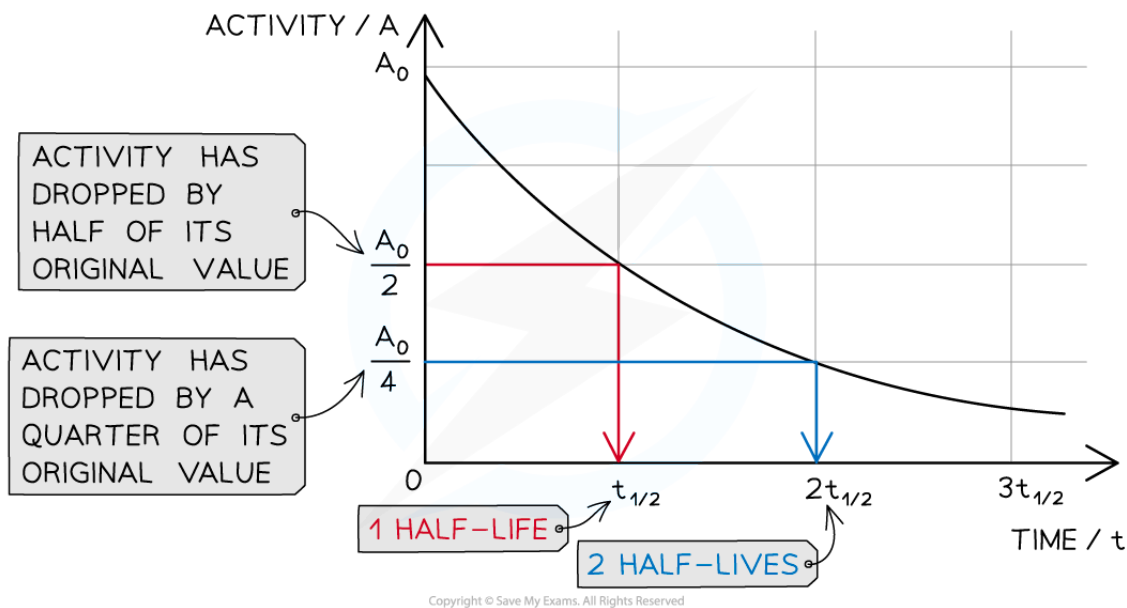

Graph showing how the activity of a radioactive sample changes over time. Each time the original activity halves, another half-life has passed

- The time it takes for the activity of the sample to decrease from 100 % to 50 % is the half-life
- It is the same length of time as it would take to decrease from 50 % activity to 25 % activity
- The half-life is **constant** for a particular isotope
- The following table shows that as the number of half-life increases, the proportion of the isotope remaining **halves**

NUMBER OF HALF-LIVES	PROPORTION OF ISOTOPE REMAINING
0	1
1	1/2
2	1/4
3	1/8
4	1/16
...	...

Copyright © Save My Exams. All Rights Reserved



Your notes

Worked example

A radioactive sample has a half-life of 3 years. What is the ratio of decayed nuclei to original nuclei, after 15 years?

Answer:

Step 1: Calculate the number of half-lives

- The time period is 15 years
- The half-life is 3 years

$$\text{half-life} = 15 / 3 = 5$$

- There have been 5 half-lives

Step 2: Raise $1/2$ to the number of half-lives

- The proportion of nuclei remaining is

$$(1/2)^5 = 1/32$$

- So $1/32$ of the original nuclei are remaining

Step 3: Write the ratio correctly

- If $1/32$ of the original nuclei are remaining, then $31/32$ must have decayed
- Therefore, the ratio is **31 decayed : 32 original**, or **31:32**

Worked example

A particular radioactive sample contains 2 million un-decayed atoms. After a year, there are only 500 000 atoms left un-decayed.

Determine the half-life of the material.

Answer:

Step 1: Calculate how many times the number of un-decayed atoms has halved

- There were 2 000 000 atoms to start with
- **1 000 000** atoms would remain after **1 half-life**
- **500 000** atoms would remain after **2 half-lives**
- Therefore, the sample has undergone 2 half-lives

Step 2: Divide the time period by the number of half-lives

- The time period is a year
- The number of half-lives is 2
- 1 year divided by 2 (2^2) is a quarter of a year or 3 months
- Therefore, the half-life of the sample is **3 months**

Decay Curves

- To calculate the half-life of a sample, the procedure is:
 - Measure the initial activity, A_0 , of the sample
 - Measure how the activity changes with time
 - Determine the half-life of this original activity
- The time taken for the activity to decrease to half its original value is the **half-life**



Your notes



Your notes

Worked example

The radioisotope technetium is used extensively in medicine. The graph below shows how the activity of a sample varies with time.

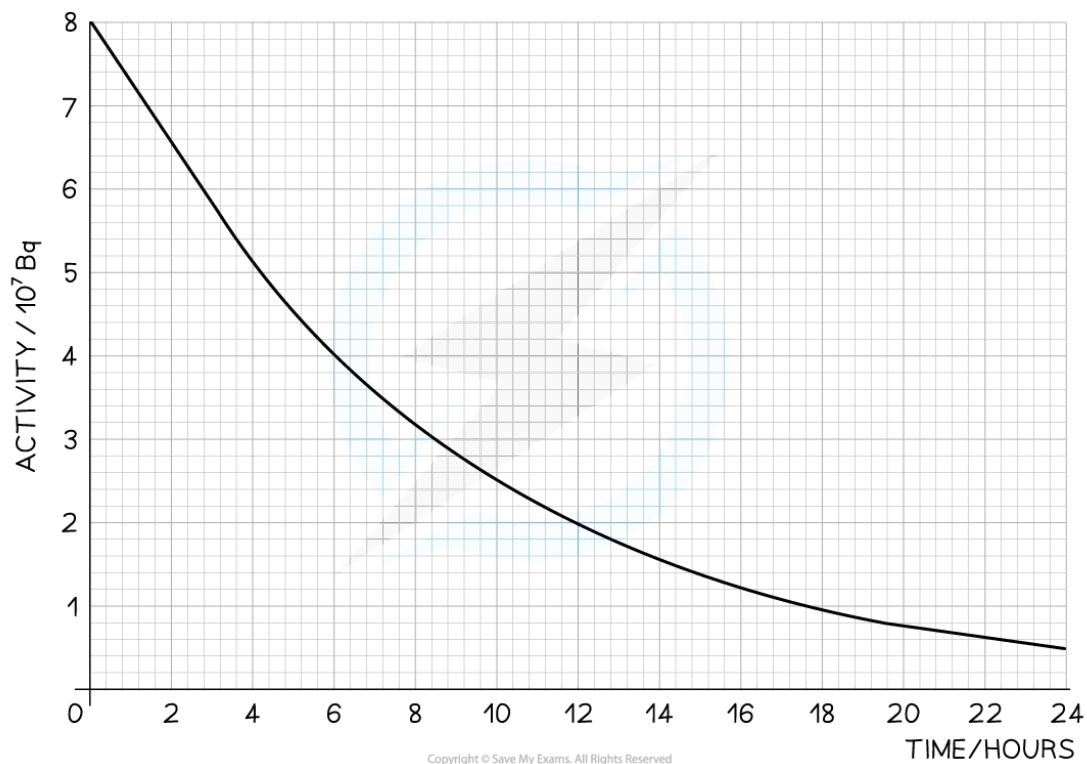

Determine the half-life of this material.

Answer:

Step 1: Draw lines on the graph to determine the time it takes for technetium to drop to half of its original activity



Your notes

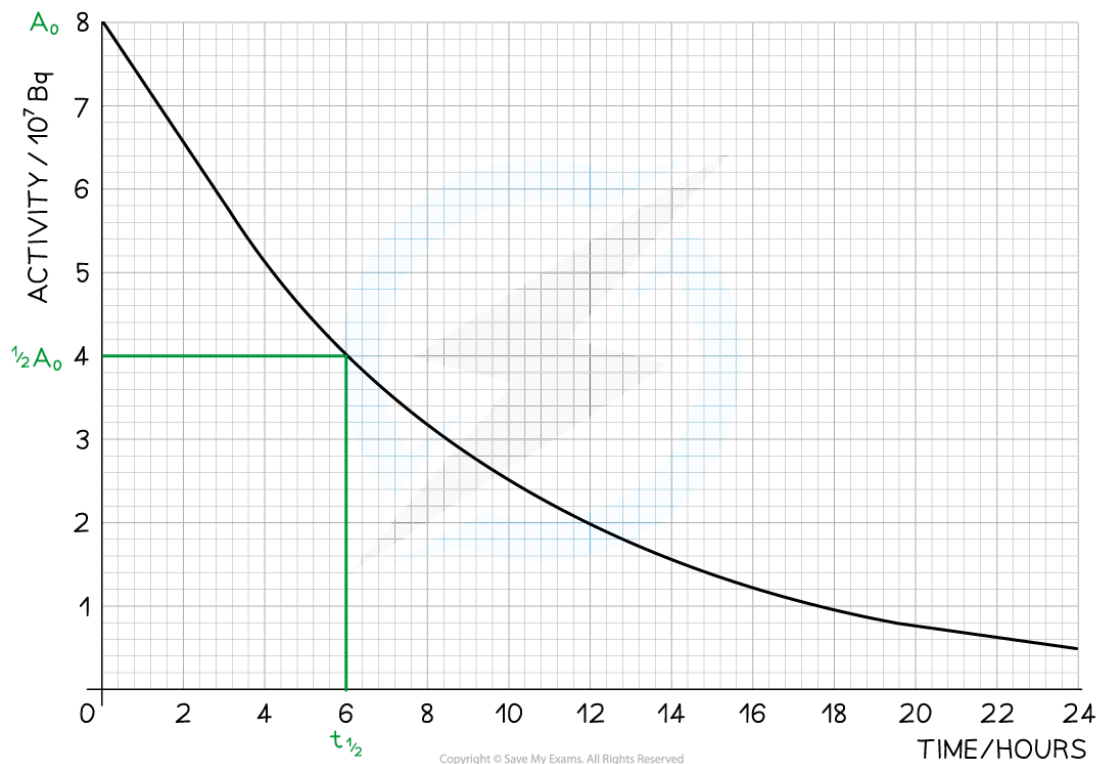

Step 2: Read the half-life from the graph

- In the diagram above the initial activity, A_0 , is 8×10^7 Bq
- The time taken to decrease to 4×10^7 Bq, or $\frac{1}{2}A_0$, is **6** hours
- The time taken to decrease to 2×10^7 Bq is **6 more** hours
- The time taken to decrease to 1×10^7 Bq is **6 more** hours
- Therefore, the half-life of this isotope is **6 hours**



Your notes

Applications of Radioactivity

Applications of Radioactivity

- When selecting a radioactive isotope for use in industry, agriculture or medicine, the key factors to consider are
 - The **penetrating power** of the decay particle
 - The **half-life** of the decay particle
- Some key examples which require the use of radioactive isotopes are:
 - [Nuclear power](#)
 - In medicine e.g. radiotherapy, tracers and sterilising equipment
 - Carbon dating
 - Uranium-lead dating for ageing rocks
 - Detecting leaks in underground pipes
 - Controlling the thickness of materials
 - Smoke detectors

Carbon Dating

- The isotope carbon-14 is commonly used in radioactive dating
- It forms as a result of cosmic rays knocking out neutrons from nuclei, which then collide with nitrogen nuclei in the air:

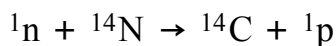

- All living organisms absorb carbon-14, but after they die they do not absorb any more
- The proportion of carbon-14 is constant in living organisms as carbon is constantly being replaced during the period they are alive
- When they die, the activity of carbon-14 in the organic matter starts to **fall**, with a half-life of around 5730 years
- Samples of living material can be tested by comparing the current amount of carbon-14 in them and compared to the initial amount (which is based on the current ratio of carbon-14 to carbon-12), and hence they can be dated

Reliability of Carbon Dating

- Carbon dating is a highly reliable method for estimating the ages of samples between **500** and **60 000 years old**
- This range can be explained by looking at the decay curve of carbon-14:

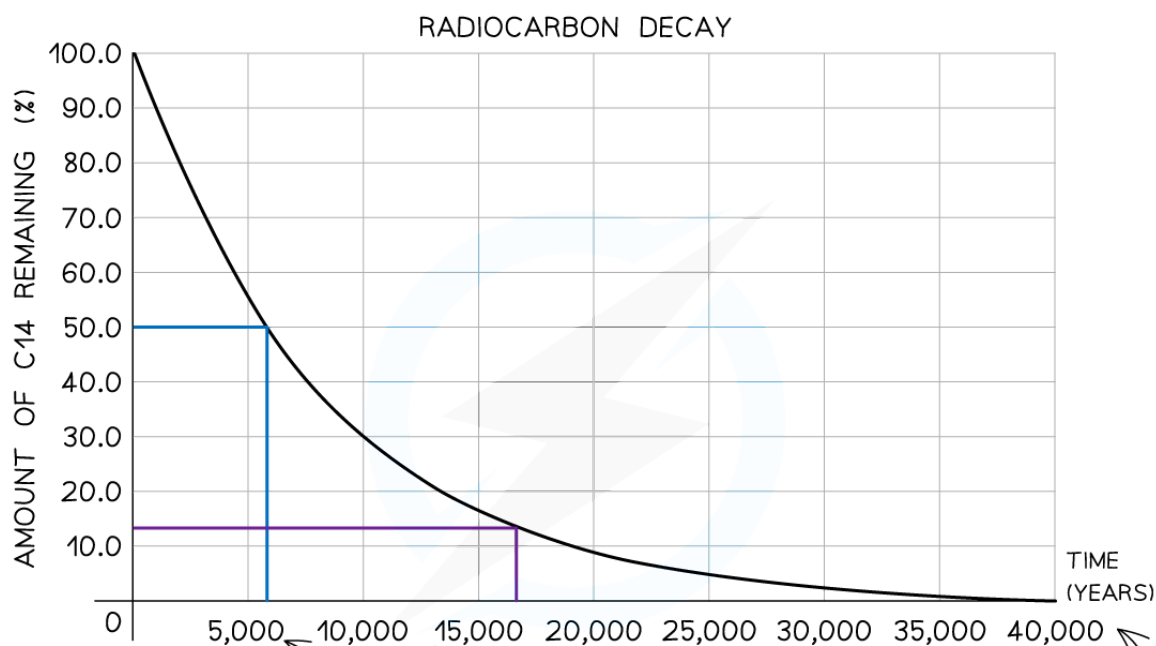

AFTER ONE HALF LIFE (5730 YEARS), ONLY HALF OF THE ORIGINAL AMOUNT REMAINS

AFTER THREE HALF LIVES (17 190 YEARS), ONLY AN EIGHTH REMAINS

AFTER 57 000 YEARS, LESS THAN 0.1% OF THE ORIGINAL AMOUNT REMAINS

Copyright © Save My Exams. All Rights Reserved

Carbon-14 decay curve used for radiocarbon dating

- If the sample is **less than 500** years old:
 - The activity of the sample will be too high to measure small changes accurately
 - Therefore, the ratio of carbon-14 to carbon-12 will be **too high** to determine an accurate age
- If the sample is **more than 60 000** years old:
 - The activity will be too low to distinguish between changes in the sample and background radiation
 - Therefore, the ratio of carbon-14 to carbon-12 will be **too small** to determine an accurate age
- Further sources of **uncertainty** arise with this dating method because:
 - The level of production of carbon-14 in the atmosphere varies slightly with location
 - The concentration of carbon-14 in the atmosphere may not have been constant over time

Uranium-Lead Dating

- For many years, scientists could not agree on the age of the Earth
- Until recently, the Earth was believed to be only millions of years old
- Over the last century, radiometric dating methods have enabled scientists to discover the age of the Earth is many **billions** of years old
- The most critical of these methods is **uranium-lead dating**

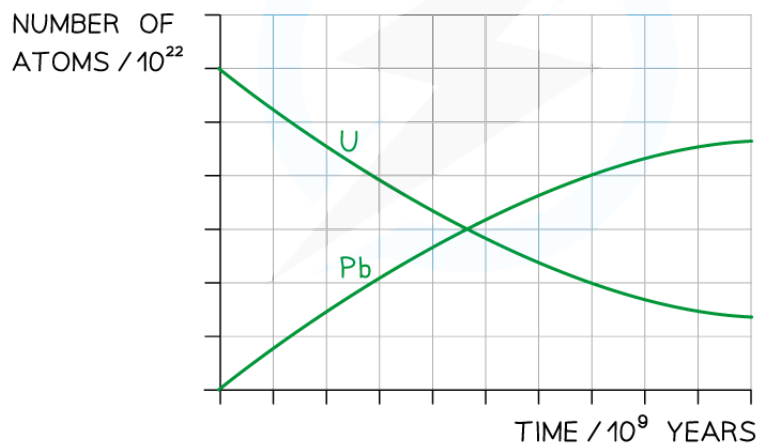
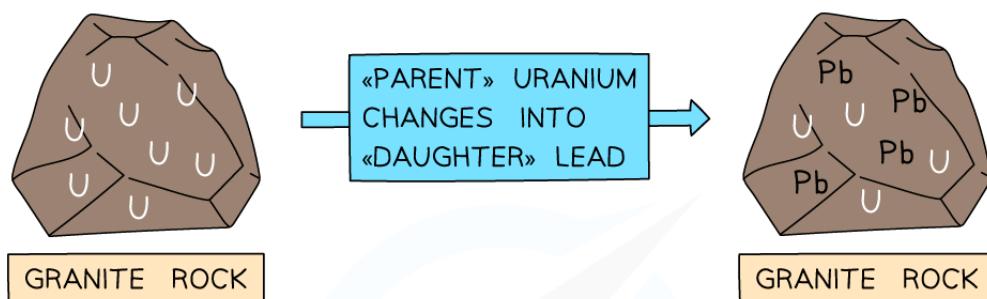

Uranium atoms decay whilst the number of lead atoms increases

- Initially, there is only uranium in the rock, but over time, the uranium decays via a decay chain which ends with lead-206, which is a stable isotope
- Uranium-238 has a half-life of **4.5 billion years**
- Over time, the ratio of lead-206 atoms to uranium-238 atoms increases
- The ratio of uranium to lead in a sample of rock can then be used to determine its age



Your notes

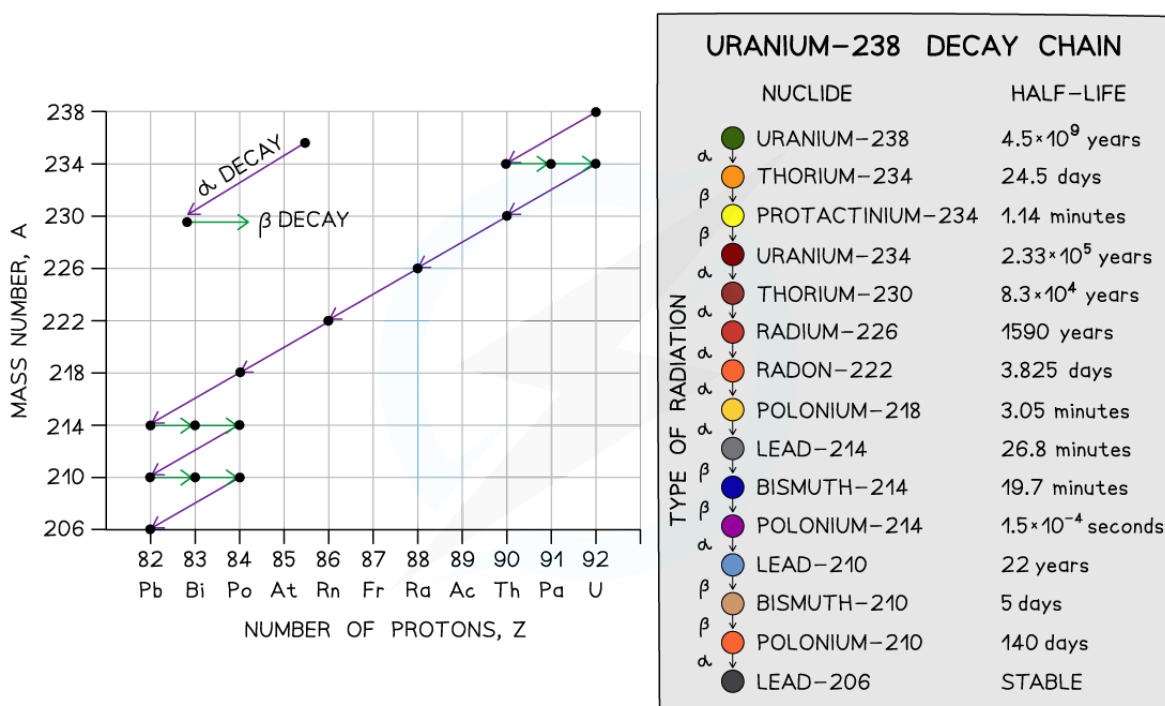

The decay chain of uranium-238 into lead-206 has been crucial for determining an accurate age of the Earth

Detecting Leaks in Underground Pipes

- Leaks in underground pipes can be detected by introducing a **gamma** emitter to the fluid supply in the pipe
- By moving a detector along the ground above the pipe, the location of the leak can be identified at the point where an increased count rate is detected
- Gamma radiation is required as it is the **most penetrating** type of radiation
 - It is the only type of radiation that would be detectable after passing through several metres of ground
 - Beta radiation could be used if the pipe is not too thick and is near the surface
- The **half-life** of the isotope must be
 - Long enough for the activity of the source to remain at detectable levels
 - Short enough that the isotope does not stay present in the supply any longer than required
- The isotope **sodium-24** is often used in leak detection
 - It emits both beta and gamma radiation and has a half-life of about 15 hours

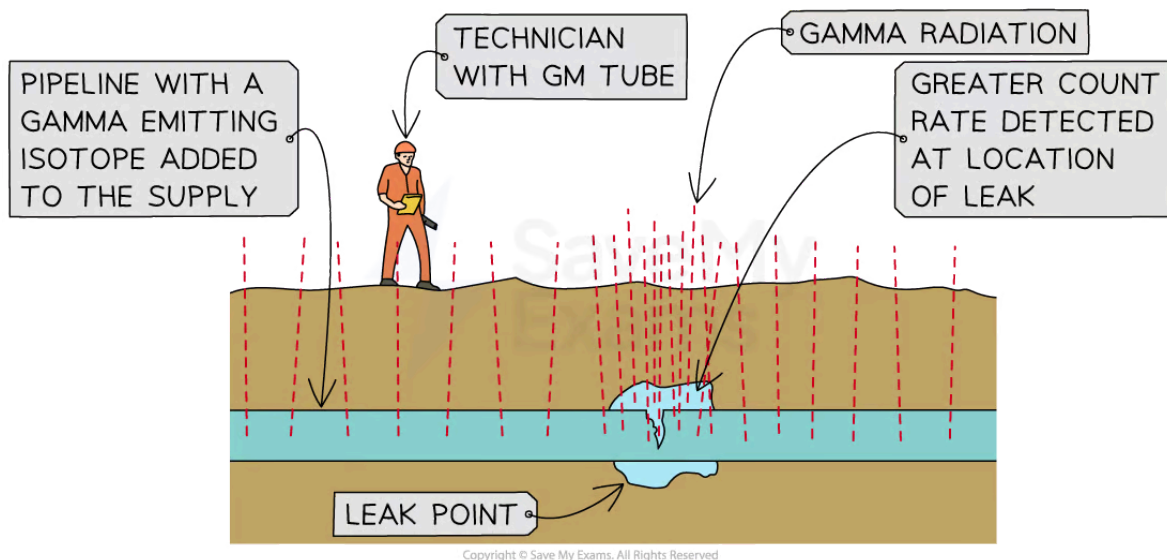

The location of a leak in an underground pipe can be found at the point where a detector records a raised count rate compared to the other points along the pipe

Controlling the Thickness of Materials

- Beta radiation can be used to determine the thickness of aluminium foil, paper, plastic, and steel
- The thickness can be controlled by measuring how much beta radiation passes through the material to a Geiger counter
- Beta radiation must be used, because:
 - Alpha particles would be absorbed by all the materials
 - Gamma radiation would pass through undetected through the materials
- The Geiger counter controls the pressure of the rollers to maintain the correct thickness
- A source with a long half-life must be chosen so that it does not need to be replaced often

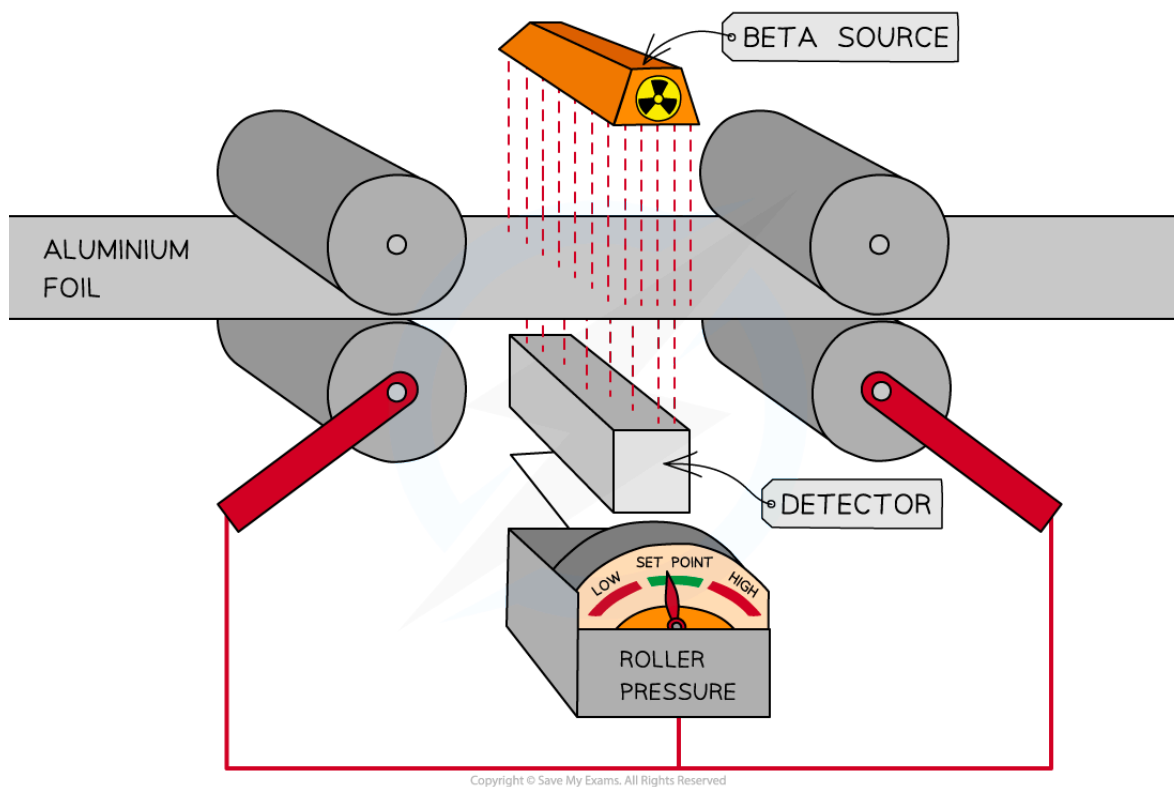

Copyright © Save My Exams. All Rights Reserved

The pressure of the rollers can be adjusted to control the thickness of the aluminium foil depending on the amount of beta radiation detected

Smoke Detectors

- Smoke detectors contain a small amount of americium-241, an alpha emitter
- Within the detector, alpha particles are emitted and cause the ionisation of nitrogen and oxygen molecules in the air
- These ionised molecules enable the air to conduct electricity by allowing a small current can flow
- If smoke enters the alarm, it absorbs the alpha particles, hence reducing the current which causes the alarm to sound
- Americium-241 has a half-life of 460 years, so throughout the lifetime of a smoke detector, the activity of the source will not decrease significantly and it will not have to be replaced



Your notes

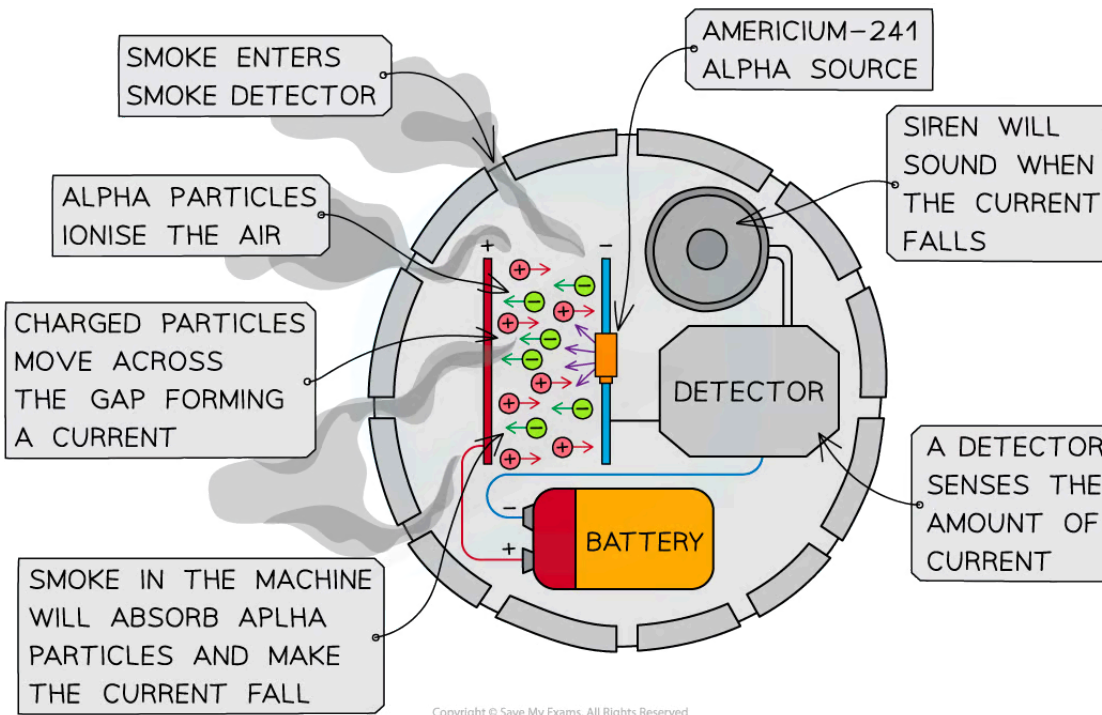

The operation of a smoke detector



Your notes

Worked example

Below are listed four radionuclides, together with the type of radiation they emit

radionuclide	type of radiation emitted
A americium-241	alpha (α)
B strontium-90	beta-minus (β^-)
C cobalt-60	beta-minus (β^-) and gamma (γ)
D fluorine-18	beta-plus (β^+)

Select the most suitable radionuclide in the following applications

- Sterilising hospital equipment sealed inside plastic bags
- Discharging static electricity that has built up in the manufacture of polyethene
- Monitoring the thickness of a thin metal being produced in a factory
- A smoke detector

(a) **ANSWER: C**

- Alpha and low energy beta radiation would most likely be absorbed by the bag
- Therefore, gamma radiation, or very high energy beta particles, would be needed to penetrate the bag
- This would be best suited to **Cobalt-60**

(b) **ANSWER: D**

- Static electricity is an imbalance of electric charges on the surface of the polythene and is generally composed of negatively charged electrons
- In order to get rid of the static charge, it will need to be neutralised
- Beta-plus particles, or positrons, are the antimatter counterpart of the electron, and hence, are oppositely charged
- When the positrons are directed at the surface of the polythene, the electrons will be attracted to them and become neutralised as the particles annihilate as they collide
- Therefore, the beta-plus emitter, **Fluorine-18**, would be best suited to this job

(c) **ANSWER: B**

- Alpha particles would **not** be suitable for measuring the thickness of metal as they can be stopped by a **thin sheet of paper**
- Gamma rays are the most penetrating of the radiations and hence would **not** be suitable where thickness monitoring is up to a few millimetres as they would **all pass through**
- Beta particles are ideally suited as they have enough energy to pass through thin sheets of metal and any changes in thickness would be easily detected
- Therefore, the beta-minus emitter **Strontium-90** would be the most suitable isotope

(d) **ANSWER: A**

- Since smoke detectors are present inside homes and other buildings, they must **pose no hazard** to residents
- This means the smoke detector must contain a **very small amount** of the radioactive material
- Also, the radiation should not be too penetrating and should only be able to travel **a few centimetres**
- Therefore, an alpha source should be selected – this means **Americium-241** would be the most suitable isotope



Your notes

Radiation in Medicine

- Radionuclides are widely used in medical applications, such as
 - Radiotherapy
 - Radioactive tracers
 - Sterilising equipment

Radiotherapy

- Gamma radiation can be used to destroy cancerous tumours
 - The gamma rays are concentrated on the tumour to protect the surrounding tissue
- Less penetrating beta radiation can be used to treat skin cancer by direct application to the affected area



Your notes

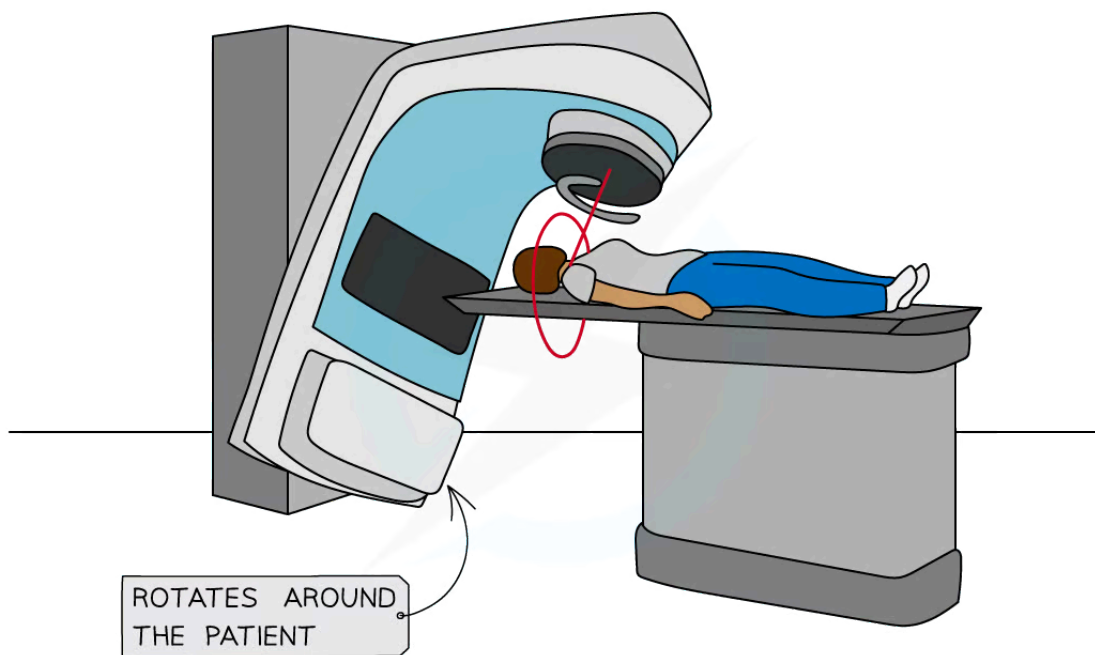

Copyright © Save My Exams. All Rights Reserved



Your notes

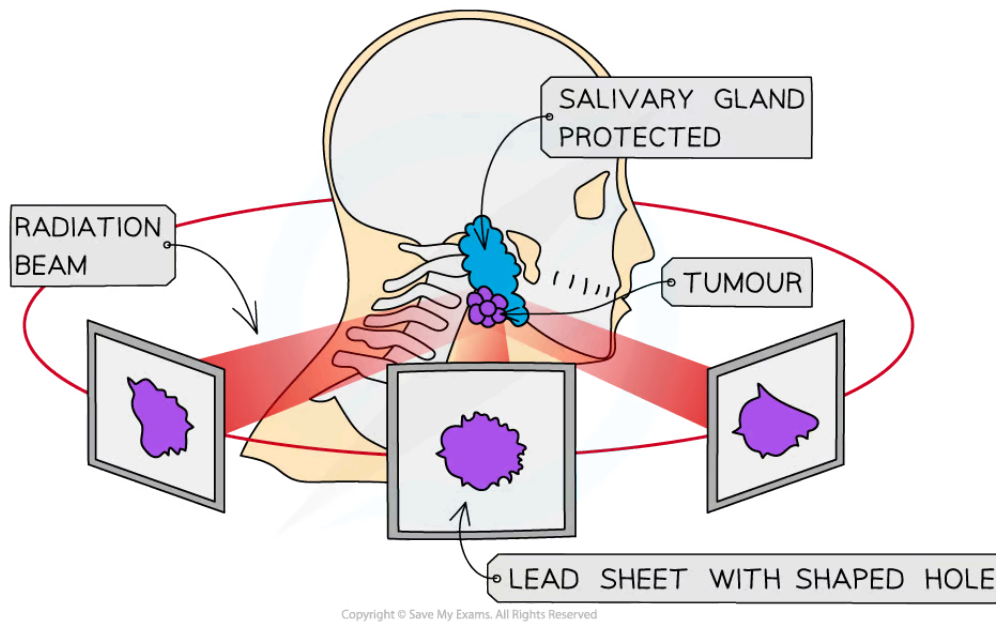

A radiotherapy machine. Powerful radiation is directed at the tumour and lead sheets can be used to prevent healthy tissue from being damaged

Radioactive Tracers

- Radioisotopes can be used as 'tracers' to monitor the processes occurring in different parts of the body
- Radioactive tracers with a short half-life are preferred because:
 - Initially, the activity is very high, so only a small sample needed
 - The shorter the half-life, the faster the isotope decays
 - Isotopes with a shorter half-life pose a much lower risk to the patient
 - The medical test doesn't last long so a half-life of a few hours is enough



Your notes

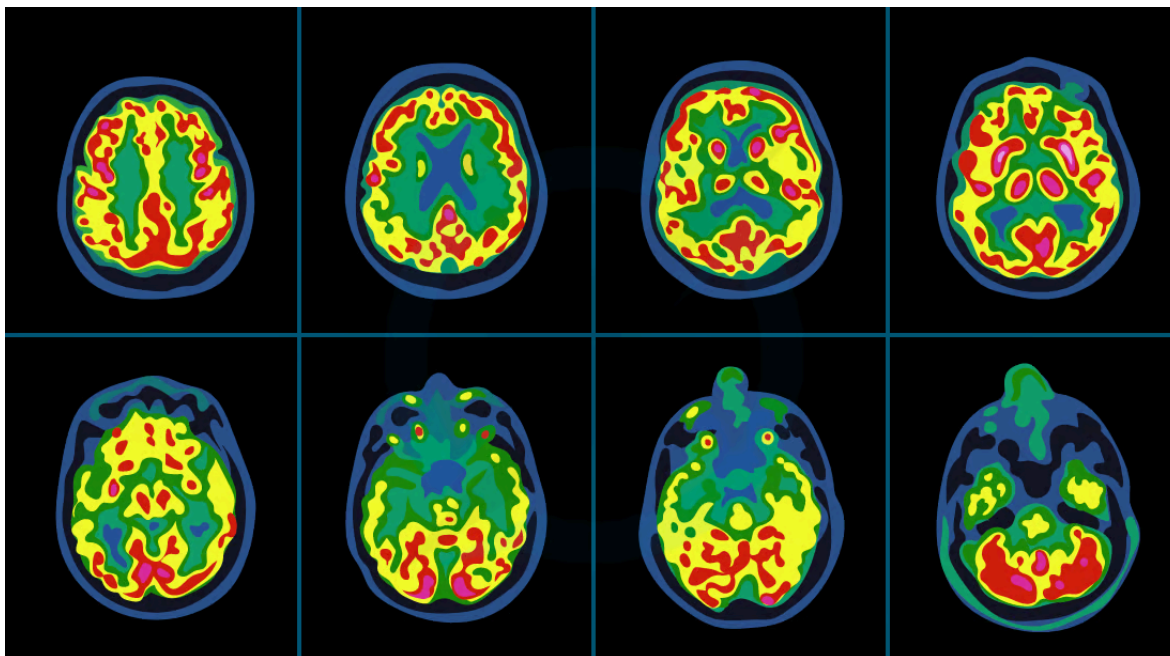

A radioactive tracer must be injected into the patient in order to take PET scan images of brain activity

- One example is **Iodine-131**
 - This isotope is known to be specifically taken up by the thyroid gland making it useful for monitoring and treating thyroid conditions
 - It emits beta particles which means it will stay concentrated on the thyroid area and nowhere else in the body
 - It has a short half-life of 8 days meaning it will not be around too long to cause prolonged exposure
- Another isotope commonly used as a tracer is **Technetium-99m**
 - It is a gamma emitter with an energy of about 140 keV which is ideal for detection
 - It has a half-life of 6 hours so it is ideal for use as a tracer, but will not remain active for too long and can be tolerated by the body
 - Gamma radiation is ideal as it is the most penetrating so it can be detected outside the body
 - Also, gamma is the weakest ioniser and causes minimal damage
 - As well as this, technetium-99m may be prepared easily at the hospital when required making it a cost-effective treatment

Sterilising Medical Equipment

- Gamma radiation is widely used to sterilise medical equipment
- Gamma is most suited to this because:
 - It is the most **penetrating** out of all the types of radiation
 - It is penetrating enough to irradiate **all sides** of the instruments
 - Instruments can be sterilised without removing the **packaging**

- The general public might be worried that using gamma radiation in this way might cause the equipment itself to become radioactive, however, this is not the case because:
 - In order for a substance to become radioactive, the **nuclei** have to be affected
 - Ionising radiation only affects the **outer electrons** and not the nucleus
 - The radioactive material is kept securely sealed away from the packaged equipment so there is **no chance of contamination**



Your notes



Your notes

Mass Defect & Nuclear Binding Energy

Mass Defect & Nuclear Binding Energy

- Experiments into nuclear structure have found that the total mass of a nucleus is **less** than the sum of the masses of its constituent nucleons
 - In other words, the combined mass of 6 separate protons and 6 separate neutrons is more than the mass of a carbon-12 nucleus
 - This difference in mass is known as the **mass defect**
- Mass defect is defined as:

The difference between the measured mass of a nucleus and the sum total of the masses of its constituents

- The mass defect Δm of a nucleus can be calculated using:

$$\Delta m = Zm_p + (A - Z)m_n - m_{total}$$

- Where:

- Z = proton number
- A = nucleon number
- m_p = mass of a proton (kg)
- m_n = mass of a neutron (kg)
- m_{total} = measured mass of the nucleus (kg)

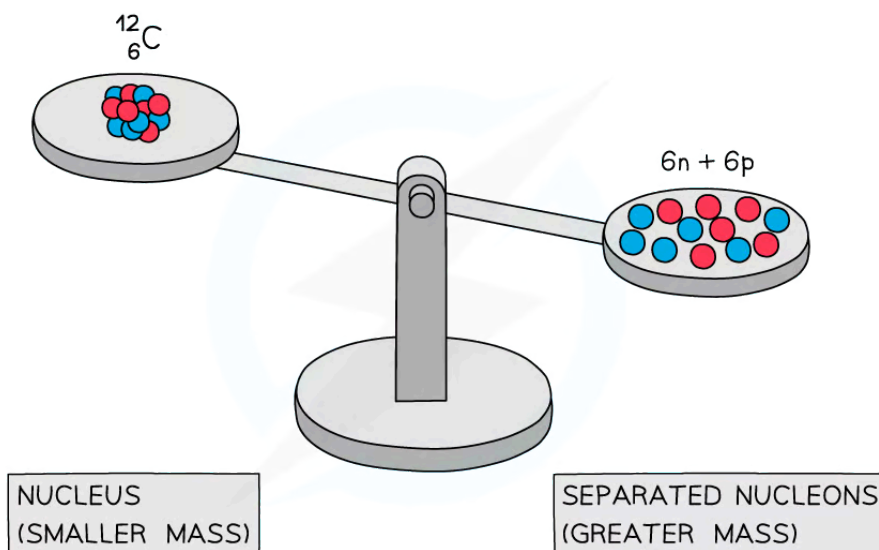

Copyright © Save My Exams. All Rights Reserved

A system of separated nucleons has a greater mass than a system of bound nucleons

- Due to mass-energy equivalence, a decrease in mass infers that energy must be released

- Energy and mass are proportional, so, the total energy of a nucleus is **less than the sum of the energies** of its constituent nucleons
- Binding energy is defined as:
The energy required to break a nucleus into its constituent protons and neutrons
- The formation of a nucleus from a system of isolated protons and neutrons **releases energy**



Your notes

Worked example

The binding energy per nucleon is 7.98 MeV for an atom of Oxygen-16 (^{16}O).

Determine an approximate value for the energy required, in MeV, to completely separate the nucleons of this atom.

Answer:

Step 1: List the known quantities

- Binding energy per nucleon, $E = 7.98 \text{ MeV}$

Step 2: State the number of nucleons

- The number of nucleons is 8 protons and 8 neutrons, therefore 16 nucleons in total

Step 3: Find the total binding energy

- The binding energy for oxygen-16 is:

$$7.98 \times 16 = 127.7 \text{ MeV}$$

Step 4: State the final answer

- The approximate total energy needed to completely separate this nucleus is **127.7 MeV**

Examiner Tip

The terms binding energy and mass defect can cause students confusion, so be careful when using them in your explanations.

Avoid describing the binding energy as the energy stored in the nucleus – this is not correct – it is energy that must be put **into** the nucleus to separate **all** the nucleons.

The same goes for the term mass defect, make sure to only use this when all the nucleons are separated and not to describe the decrease in mass which occurs during radioactive decay.



Your notes

Mass–Energy Equivalence

- Einstein showed in his Theory of Relativity that matter can be considered a form of energy and hence, he proposed:
 - Mass can be converted into energy
 - Energy can be converted into mass
- This is known as **mass–energy equivalence**, and can be summarised by the equation:

$$\Delta E = \Delta mc^2$$

- Where:
 - E = energy (J)
 - m = mass (kg)
 - c = the speed of light (m s^{-1})
- Some examples of mass–energy equivalence are:
 - The **fusion** of hydrogen into helium in the centre of the sun
 - The **fission** of uranium in nuclear power plants
 - Nuclear **weapons**
 - High-energy **particle collisions** in particle accelerators

Atomic Mass Unit

- The **atomic mass unit** is commonly used in nuclear physics to express the mass of subatomic particles
- It is defined as:

Exactly one twelfth $\left(\frac{1}{12}\right)$ the mass of a neutral atom of carbon-12

- Atomic mass unit u is roughly equal to the mass of one proton or neutron:
 - $1u = 1.661 \times 10^{-27} \text{ kg}$
- Using more precise values for well-known constants, a useful conversion factor can be determined
- A particle with a mass of $1u$ has an equivalent energy of

$$E = mc^2 = (1.66053907 \times 10^{-27}) \times (2.99792458 \times 10^8)^2 = 1.49241809 \times 10^{-10} \text{ J}$$

- Converting to eV by using the precise value of elementary charge gives

$$E = \frac{1.49241809 \times 10^{-10}}{1.60217663 \times 10^{-19}} = 931.494 \text{ MeV}$$

- Therefore, the unified atomic mass unit can be used to quickly **convert** between nuclear mass and energy using:
 - $1u = 1.661 \times 10^{-27} \text{ kg} = 931.5 \text{ MeV c}^{-2}$



Your notes

Worked example

Calculate the binding energy per nucleon, in MeV, for the radioactive isotope potassium-40 (${}_{19}^{40}\text{K}$).

You may use the following data:

- Nuclear mass of potassium-40 = 39.953 548 u
- Mass of one neutron = 1.008 665 u
- Mass of one proton = 1.007 276 u

Answer:

Step 1: Identify the number of protons and neutrons in potassium-40

- Proton number, $Z = 19$
- Neutron number, $N = 40 - 19 = 21$

Step 2: Calculate the mass defect, Δm

- Proton mass, $m_p = 1.007\,276\text{ u}$
- Neutron mass, $m_n = 1.008\,665\text{ u}$
- Mass of potassium-40, $m_{\text{total}} = 39.953\,548\text{ u}$

$$\Delta m = Zm_p + Nm_n - m_{\text{total}}$$

$$\Delta m = (19 \times 1.007276) + (21 \times 1.008665) - 39.953548$$

$$\Delta m = 0.36666\text{ u}$$

Step 3: Convert mass units from u to kg

- $1\text{ u} = 1.661 \times 10^{-27}\text{ kg}$

$$\Delta m = 0.36666 \times (1.661 \times 10^{-27}) = 6.090 \times 10^{-28}\text{ kg}$$

Step 4: Write down the equation for mass-energy equivalence

$$E = \Delta mc^2$$

- Where $c = 3.0 \times 10^8\text{ m s}^{-1}$

Step 5: Calculate the binding energy, E

$$E = 6.090 \times 10^{-28} \times (3.0 \times 10^8)^2 = 5.5 \times 10^{-11}\text{ J}$$

Step 6: Determine the binding energy per nucleon and convert J to MeV

- Take the binding energy and divide it by the number of nucleons
- $1\text{ MeV} = 1.6 \times 10^{-13}\text{ J}$

$$\text{Binding energy per nucleon} = \frac{5.5 \times 10^{-11}}{40} = 1.375 \times 10^{-12}\text{ J}$$

$$\text{Binding energy per nucleon} = \frac{1.375 \times 10^{-12}}{1.6 \times 10^{-13}} = 8.594 \text{ MeV}$$



Your notes



Your notes

Binding Energy per Nucleon Curve

Binding Energy per Nucleon Curve

- In order to compare nuclear stability, it is useful to look at the **binding energy per nucleon**
- The binding energy per nucleon is defined as:

The binding energy of a nucleus divided by the number of nucleons in the nucleus
- A higher binding energy per nucleon indicates a higher stability
- In other words, more energy is required to separate the nucleons contained within a nucleus

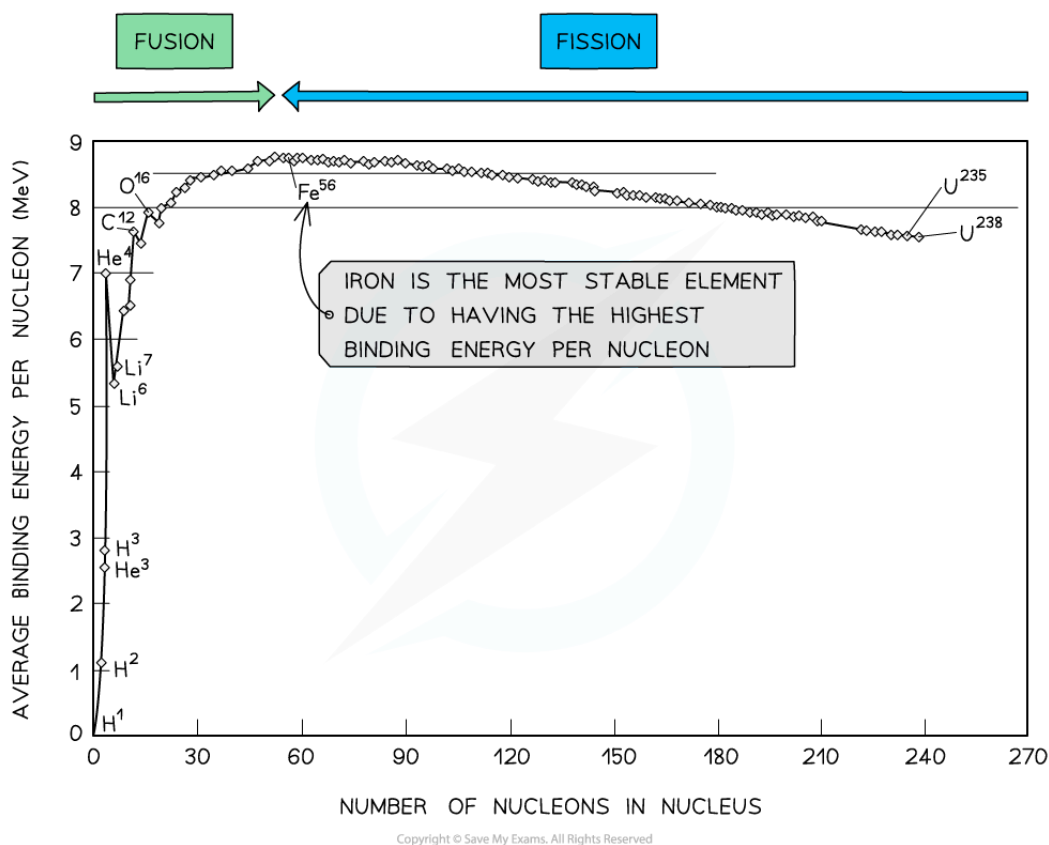

By plotting a graph of binding energy per nucleon against nucleon number, the stability of elements can be inferred

Key Features of the Graph

- At low values of A:
 - Nuclei have lower binding energies per nucleon than at large values of A, but they tend to be stable when $N = Z$



Your notes

- This means light nuclei have weaker electrostatic forces and will undergo **fusion**
- The gradient is **much steeper** compared to the gradient at large values of A
- This means that fusion reactions release a greater binding energy than fission reactions
- At high values of A :
 - Nuclei have generally higher binding energies per nucleon, but this gradually decreases with A
 - This means the heaviest elements are the most unstable and will undergo **fission**
 - The gradient is **less steep** compared to the gradient at low values of A
 - This means that fission reactions release less binding energy than fission reactions
- Iron ($A = 56$) has the highest binding energy per nucleon, which makes it the **most stable** of all the elements
- Helium (${}^4\text{He}$), carbon (${}^{12}\text{C}$) and oxygen (${}^{16}\text{O}$) do not fit the trend
 - Helium-4 is a particularly stable nucleus hence it has a **high** binding energy per nucleon
 - Carbon-12 and oxygen-16 can be considered to be three and four helium nuclei, respectively, bound together

Comparing Fusion & Fission

Similarities

- In both fusion and fission, the total mass of the products is slightly **less** than the total mass of the reactants
- The mass defect is equivalent to the binding energy that is released
- As a result, both fusion and fission reactions **release energy**

Differences

- In fusion, two smaller nuclei **combine** into a larger nucleus
- In fission, an unstable nucleus **splits** into two smaller nuclei
- Fusion occurs between **light** nuclei ($A < 56$)
- Fission occurs in **heavy** nuclei ($A > 56$)
- In light nuclei, **attractive** nuclear forces dominate over repulsive electrostatic forces between protons, and this contributes to nuclear **stability**
- In heavy nuclei, **repulsive** electrostatic forces between protons begin to dominate over attractive nuclear forces, and this contributes to nuclear **instability**
- Fusion releases much **more** energy per kg than fission
- Fusion requires a greater initial **input** of energy than fission



Your notes

Worked example

The equation below represents one possible decay of the induced fission of a nucleus of uranium-235.

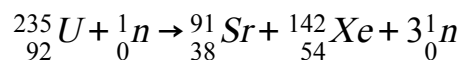

The graph shows the binding energy per nucleon plotted against nucleon number A.

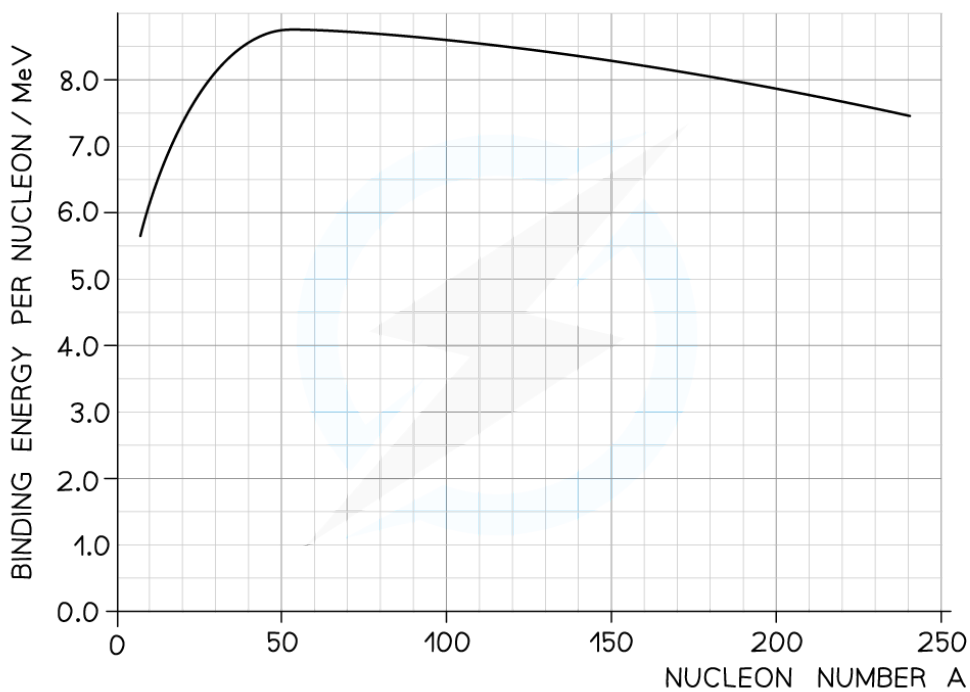

Calculate the energy released

- (a) by the fission process represented by the equation
- (b) when 1.0 kg of uranium, containing 3% by mass of U-235, undergoes fission

Answer:

Part (a)

Step 1: Use the graph to identify each isotope's binding energy per nucleon

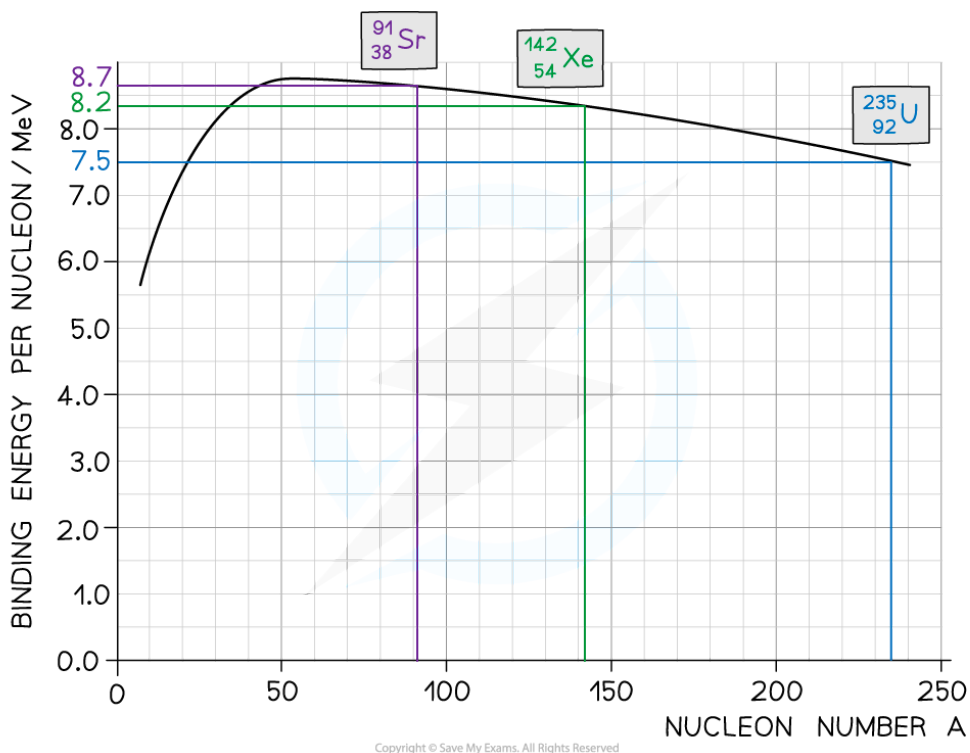

- Binding energy per nucleon (U-235) = 7.5 MeV
- Binding energy per nucleon (Sr-91) = 8.2 MeV
- Binding energy per nucleon (Xe-142) = 8.7 MeV

Step 2: Determine the binding energy of each isotope

$$\text{Binding energy} = \text{Binding Energy per Nucleon} \times \text{Mass Number}$$

- Binding energy of U-235 nucleus = $(235 \times 7.5) = 1763 \text{ MeV}$
- Binding energy of Sr-91 = $(91 \times 8.2) = 746 \text{ MeV}$
- Binding energy of Xe-142 = $(142 \times 8.7) = 1235 \text{ MeV}$

Step 3: Calculate the energy released

$$\text{Energy released} = \text{Binding energy after (Sr + Xe)} - \text{Binding energy before (U)}$$

$$\text{Energy released} = (1235 + 746) - 1763 = 218 \text{ MeV}$$

Part (b)

Step 1: Calculate the energy released by 1 mol of uranium-235

- There are N_A (Avogadro's number) atoms in 1 mol of U-235, which is equal to a mass of 235 g
- Energy released by 235 g of U-235 = $(6 \times 10^{23}) \times 218 \text{ MeV}$

Step 2: Convert the energy released from MeV to J

- $1 \text{ MeV} = 1.6 \times 10^{-13} \text{ J}$

- Energy released = $(6 \times 10^{23}) \times 218 \times (1.6 \times 10^{-13}) = 2.09 \times 10^{13} \text{ J}$

Step 3: Work out the proportion of uranium-235 in the sample

- 1 kg of uranium which is 3% U-235 contains 0.03 kg or 30 g of U-235

Step 4: Calculate the energy released by the sample

$$\text{Energy released from 1 kg of Uranium} = (2.09 \times 10^{13}) \times \frac{30}{235} = 2.67 \times 10^{12} \text{ J}$$



Your notes

Examiner Tip

Checklist on what to include (and what not to include) in an exam question asking you to draw a graph of binding energy per nucleon against nucleon number:

- Do not begin your curve at $A = 0$, this is not a nucleus!
- Make sure to correctly label both axes AND units for binding energy per nucleon
- You will be expected to include numbers on the axes, mainly at the peak to show the position of iron (^{56}Fe)



Your notes

Strong Nuclear Force

- In a nucleus, there are
 - Repulsive **electric** forces between protons due to their positive charge
 - Attractive **gravitational** forces due to the mass of the nucleons
- Gravity is the weakest of the fundamental forces, so it has a negligible effect compared to electric repulsion between protons
- If these were the only forces acting, the nucleus would not hold together
- Therefore, there must be an **attractive** force acting between all nucleons which is **stronger** than the electric repulsive force
 - This is known as the **strong nuclear force**
- The strong nuclear force acts between particles called **quarks**
- Protons and neutrons are made up of quarks, so the interaction between the quarks in the nucleons keeps them bound within a nucleus

ELECTROSTATIC REPULSION FORCES THE PROTONS IN THE NUCLEUS APART

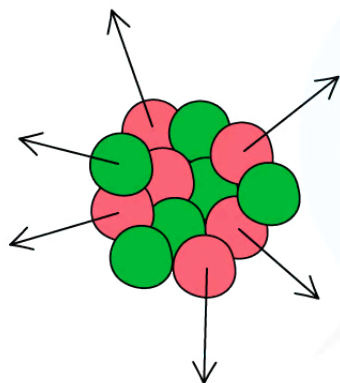

THE STRONG FORCE HOLDS ALL THE NUCLEONS TOGETHER



KEY

● = PROTON

● = NEUTRON

Copyright © Save My Exams. All Rights Reserved

Whilst the electrostatic force is a repulsive force in the nucleus, the strong nuclear force holds the nucleus together

Properties of the Strong Nuclear Force

- The strength of the strong nuclear force between two nucleons varies with the separation between them
- This can be plotted on a graph which shows how the force changes with separation

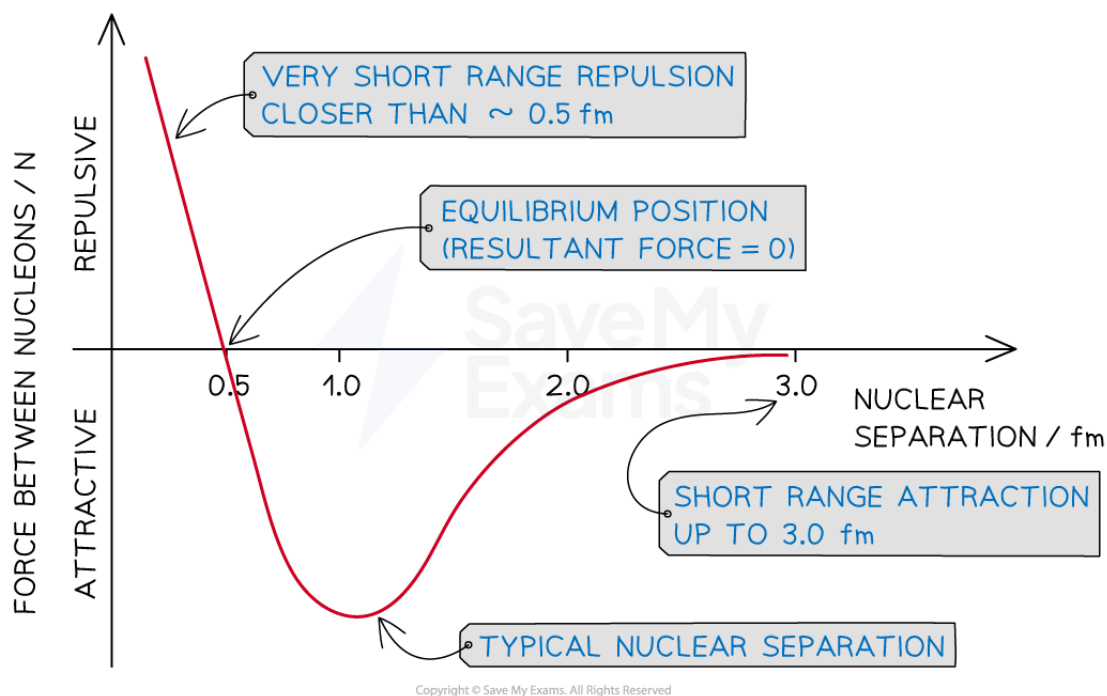

The strong nuclear force is repulsive below a separation of 0.5 fm and attractive up to 3.0 fm

- The key features of the graph are:
 - The strong force is **highly repulsive** at separations below 0.5 fm
 - The strong force is **very attractive** up to a nuclear separation of 3.0 fm
 - The **maximum** attractive value occurs at around 1.0 fm, which is a typical value for nucleon separation
 - The **equilibrium position**, where the resultant force is zero, occurs at a separation of about 0.5 fm
- In comparison to other fundamental forces, the strong nuclear force has a **very small range** (from 0.5 to 3.0 fm)

Comparison of Electrostatic and Strong Forces

- The graph below shows how the strength of the electrostatic and strong forces between two nucleons vary with the separation between them
 - The **red** curve represents the strong nuclear force between nucleons
 - The **blue** curve represents the electrostatic repulsion between protons

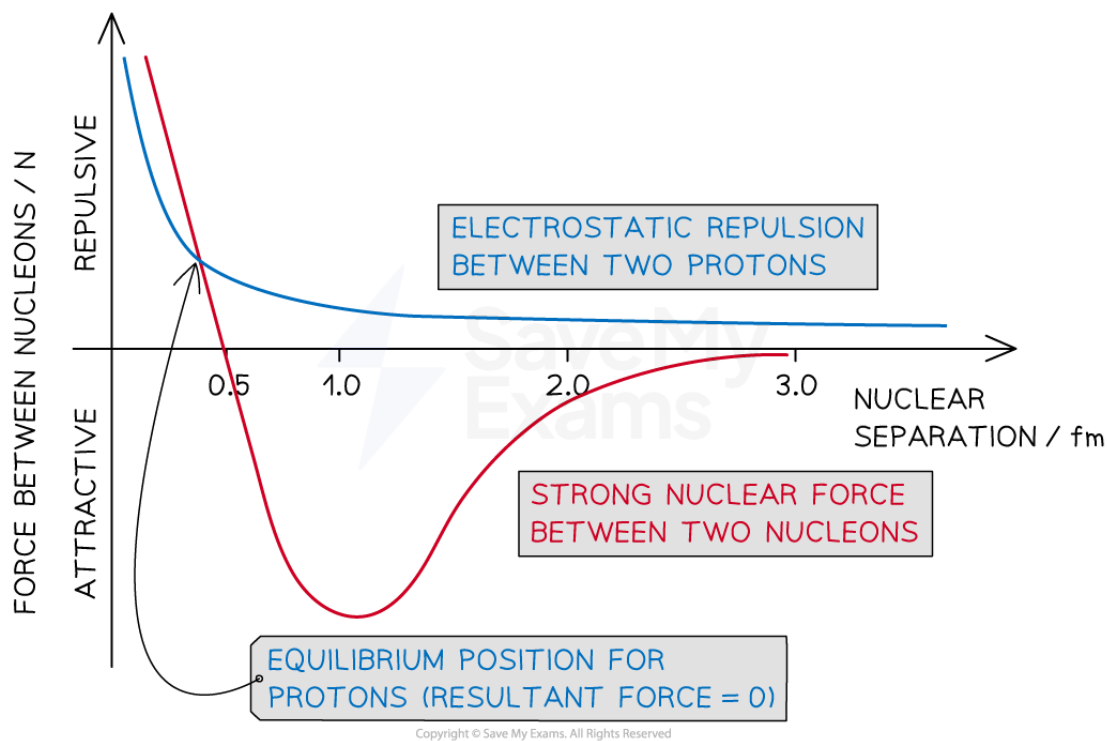

At separations between 0.5 and 3.0 fm, the attraction of the strong force is far more powerful than the repulsion of the electrostatic force

- The repulsive electrostatic force between protons has a much **larger range** than the strong nuclear force
 - However, it only becomes significant when the proton separation is more than around 2.5 fm
- The electrostatic force is influenced by charge, whereas the strong nuclear force is not
- This means the strength of the strong nuclear force is roughly the **same** between all types of nucleon (i.e. proton-proton, neutron-neutron and proton-neutron)
 - This only applies for separations between 0.5 and 3.0 fm (where the electrostatic force between protons is insignificant)
- The **equilibrium position for protons**, where the electrostatic repulsive and strong attractive forces are equal, occurs at a separation slightly below 0.5 fm

Examiner Tip

You may see the strong nuclear force also referred to as the **strong interaction**

Make sure you can describe how the strong nuclear force varies with the separation of nucleons - make sure you remember the key values: range = 0.5 to 3.0 fm and typical nuclear separation ≈ 1.0 fm.

Remember to write that after 3 fm, the strong force becomes 'zero' or 'has no effect' rather than it is 'negligible'.

Recall that 1 fm, or 1 femtometre, is 1×10^{-15} m



Your notes