



# SL IB Chemistry

  
Your notes

## The Covalent Model

### Contents

- \* Covalent Bonds
- \* Lewis Formulas
- \* Multiple Bonds
- \* Coordinate Bonds
- \* Shapes of Molecules
- \* Bond Polarity
- \* Molecular Polarity
- \* Giant Covalent Structures
- \* Intermolecular Forces
- \* Physical Properties of Covalent Substances
- \* Chromatography



Your notes

## Covalent Bonds

### Covalent Bonds

#### What are covalent bonds?

- **Covalent** bonding occurs between two **non-metals**
- A covalent bond involves the **electrostatic attraction** between nuclei of two atoms and the electrons of their outer shells
- **No electrons** are **transferred** but only **shared** in this type of bonding
- When a covalent bond is formed, two **atomic orbitals** overlap and a **molecular orbital** is formed
- Covalent bonding happens because the electrons are more stable when attracted to two nuclei than when attracted to only one

#### Diagram to show the formation of a covalent bond in a hydrogen molecule

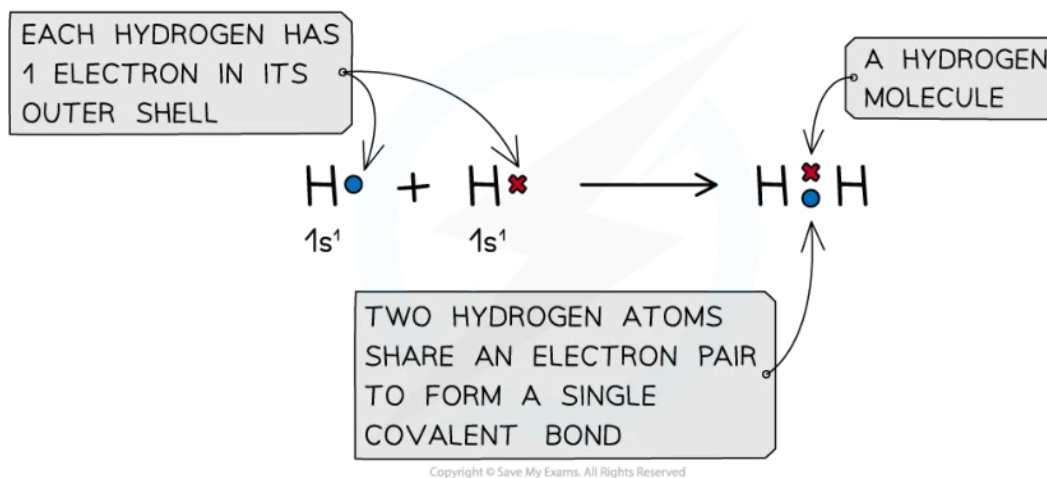

*The positive nucleus of each atom has an attraction for the bonding electrons shared in the covalent bond*

- In a normal covalent bond, each atom provides one of the electrons in the bond. A covalent bond is represented by a short straight line between the two atoms, H-H
- Covalent bonds should not be regarded as shared electron pairs in a fixed position; the electrons are in a state of constant motion and are best regarded as **charge clouds**

#### Hydrogen Molecular Orbital Diagram



Your notes

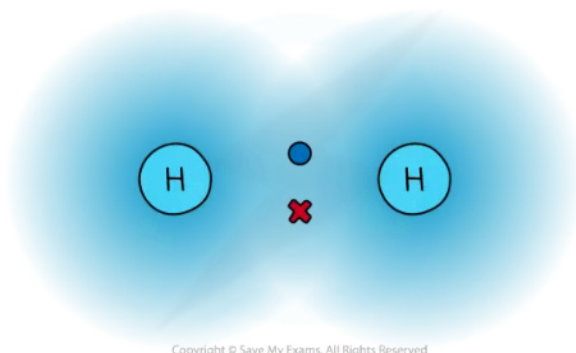

**A representation of electron charge clouds. The electrons can be found anywhere in the charge clouds**

- **Non-metals** are able to **share** pairs of electrons to form different types of covalent bonds
- Sharing electrons in the covalent bond allows each of the 2 atoms to achieve an electron configuration similar to a noble gas
  - This makes each atom more stable
- The **octet rule** refers to the tendency of atoms to gain a valence shell with a total of 8 electrons
- In some instances, the central atom of a covalently bonded molecule can accommodate **more** or **less** than 8 electrons in its outer shell
  - Being able to accommodate **more** than 8 electrons in the outer shell is known as '**expanding the octet rule**'
  - Accommodating **less** than 8 electrons in the outer shell means that the central atom is '**electron deficient**'
  - Some examples of this can be found in the section on Lewis structures

### **Examiner Tip**

Covalent bonding takes place between two nonmetal atoms. Remember to use the periodic table to decide how many electrons are in the outer shell of a nonmetal atom.



Your notes

## Lewis Formulas

### Lewis Formulas

- **Lewis formulas** are simplified electron shell diagrams and show pairs of electrons around atoms.
- A pair of electrons can be represented by dots, crosses, a combination of dots and crosses or by a line.  
For example, chlorine can be shown as:



*Different Lewis Formulas for chlorine molecules*

- Note: Cl-Cl is not a **Lewis formula**, since it does not show all the electron pairs.
- The “**octet rule**” refers to the tendency of atoms to gain a valence shell with a total of 8 electrons

### Steps for drawing Lewis Formulas

1. Count the total number of **valence electrons**
2. Draw the **skeletal structure** to show how many atoms are linked to each other.
3. Use a pair of crosses or dot/cross to put an electron pair in each bond between the atoms.
4. Add more electron pairs to complete the octets around the atoms (except H which has 2 electrons)
5. If there are not enough electrons to complete the octets, form double/triple bonds.
6. Check the total number of electrons in the finished structure is equal to the total number of **valence electrons**

### Worked example

Draw a Lewis formula for  $\text{CCl}_4$ .

Answer:

- 1 TOTAL NUMBER OF VALENCE ELECTRONS =  $\text{C} + 4\text{Cl} = 4 + (4 \times 7) = 32$
- 2 DRAW THE SKELETAL POSITIONS
- 3 ADD THE BONDING PAIRS
- 4 COMPLETED LEWIS FORMULA

ADD 24 LONE PAIR ELECTRONS

4 BONDING PAIRS MEANS  $32 - 8 = 24$  ELECTRONS LEFT

LONE PAIRS

Copyright © Save My Exams. All Rights Reserved

Steps in drawing the Lewis formula for  $\text{CCl}_4$

### Further examples of Lewis formulas

- Follow the steps for drawing Lewis structures for these common molecules

Molecule	Total number of valence electrons	Lewis formula
$\text{CH}_4$	$\text{C} + 4\text{H}$ $4 + (4 \times 1) = 8$	$\begin{array}{c} \text{H} \\ \vdots \\ \text{H} : \text{C} : \text{H} \\ \vdots \\ \text{H} \end{array}$



NH <sub>3</sub>	$N + 3H$ $5 + (3 \times 1) = 8$	$\begin{array}{c} \cdot\cdot \\ H : \ddot{N} : H \\ \cdot\cdot \\ H \end{array}$
H <sub>2</sub> O	$2H + O$ $(2 \times 1) + 6 = 8$	$\begin{array}{c} \cdot\cdot \\ H : \ddot{O} : \\ \cdot\cdot \\ H \end{array}$
CO <sub>2</sub>	$C + 2O$ $4 + (2 \times 6) = 16$	$\cdot\cdot \quad \cdot\cdot \quad \cdot\cdot \quad \cdot\cdot \\ \cdot\cdot : O : : C : : O : \cdot\cdot \\ \cdot\cdot \quad \cdot\cdot \quad \cdot\cdot \quad \cdot\cdot$
HCN	$H + C + N$ $1 + 4 + 5 = 10$	$H - C \equiv \ddot{N}$

## Incomplete Octets

- For elements below atomic number 20 the **octet rule** states that the atoms try to achieve 8 electrons in their valence shells, so they have the same electron configuration as a noble gas
- However, there are some elements that are exceptions to the **octet rule**, such as H, Li, Be, B and Al
  - H can achieve a stable arrangement by gaining an electron to become  $1s^2$ , the same structure as the noble gas helium
  - Li does the same, but losing an electron and going from  $1s^2 2s^1$  to  $1s^2$  to become a  $Li^+$  ion
  - Be from group 2, has two valence electrons and forms stable compounds with just four electrons in the valence shell
  - B and Al in group 13 have 3 valence electrons and can form stable compounds with only 6 valence electrons
- There are two examples of **Lewis structures** with incomplete octets you should know, BeCl<sub>2</sub> and BF<sub>3</sub>:

Molecule	Total number of valence electrons	Lewis formula
BeCl <sub>2</sub>	$Be + 2Cl =$ $2 + (2 \times 7) = 16$	$\cdot\cdot \quad \cdot\cdot \quad \cdot\cdot \quad \cdot\cdot \\ : \ddot{Cl} : \times Be : \times \ddot{Cl} : \\ \cdot\cdot \quad \cdot\cdot \quad \cdot\cdot \quad \cdot\cdot$
BF <sub>3</sub>	$B + 3F =$ $3 + (3 \times 7) = 24$	$\cdot\cdot \quad \cdot\cdot \quad \cdot\cdot \quad \cdot\cdot \quad \cdot\cdot \quad \cdot\cdot \\ \cdot\cdot : F : \cdot\cdot \\ \cdot\cdot \quad \cdot\cdot \quad \cdot\cdot \quad \cdot\cdot \quad \cdot\cdot \quad \cdot\cdot \\ \cdot\cdot : F : \times B : \times F : \cdot\cdot \\ \cdot\cdot \quad \cdot\cdot \quad \cdot\cdot \quad \cdot\cdot \quad \cdot\cdot \quad \cdot\cdot$

- Test your understanding of Lewis diagrams in the following example:

### Worked example

How many electrons are in the 2-aminoethanoic acid molecule?

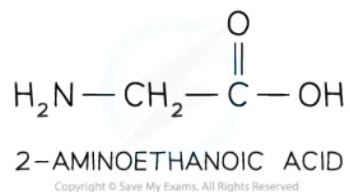

- A. 18
- B. 20
- C. 28
- D. 30

**Answer:**

- The correct option is **D** because:
  - You must count the lone pairs on N and O as well as the bonding pairs. There are 5 'hidden' pairs of bonding electrons in the OH, CH<sub>2</sub> and NH<sub>2</sub> groups
  - Hydrogen does not follow the octet rule

### Examiner Tip

Lewis formulas are also known as electron dot or Lewis structures.



Your notes



Your notes

## Multiple Bonds

### Multiple Bonds

- **Non-metals** are able to **share** more than one pair of electrons to form different types of covalent bonds
- Sharing electrons in the covalent bond allows each of the 2 atoms to achieve an electron configuration similar to a noble gas
  - This makes each atom more stable
- It is not possible to form a quadruple bond as the repulsion from having 8 electrons in the same region between the two nuclei is too great

**Covalent Bonds & Shared Electrons Table**

Type of covalent bond	Number of electrons shared
Single (C – C)	2
Double (C = C)	4
Triple (C ≡ C)	6

### Bond energy

- The **bond energy** is the energy required to **break** one mole of a particular covalent bond in the gaseous states
  - Bond energy has units of  $\text{kJ mol}^{-1}$
- The **larger** the bond energy, the **stronger** the covalent bond is

### Bond length

- The **bond length** is **internuclear distance of two covalently bonded atoms**
  - It is the distance from the nucleus of one atom to another atom which forms the covalent bond
- The **greater** the forces of attraction between electrons and nuclei, the more the atoms are pulled closer to each other
- This **decreases** the **bond length** of a molecule and **increases** the **strength** of the covalent bond
- **Triple bonds** are the **shortest** and **strongest** covalent bonds due to the large electron density between the nuclei of the two atoms
- This increase the forces of attraction between the electrons and nuclei of the atoms



- As a result of this, the atoms are pulled closer together causing a shorter bond length
- The increased forces of attraction also means that the covalent bond is **stronger**



Your notes

Diagram to show bond lengths for carbon

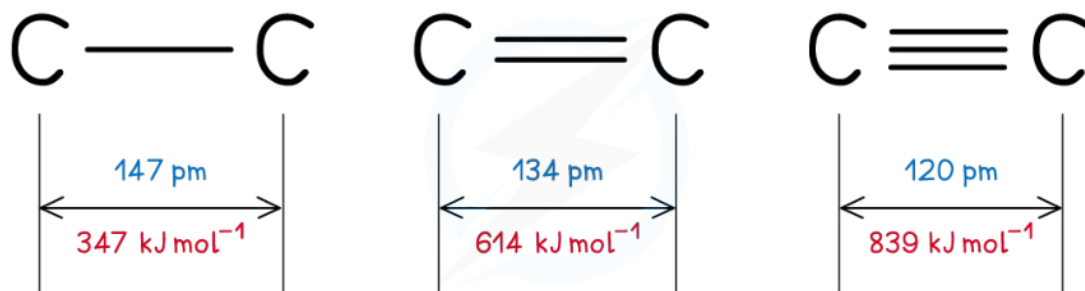

Copyright © Save My Exams. All Rights Reserved

*Triple bonds are the shortest covalent bonds and therefore the strongest ones*

### Examiner Tip

#### Remember:

Single covalent bonds are the longest and weakest

Triple covalent bonds are the shortest and strongest



Your notes

## Coordinate Bonds

### Coordinate Bonds

#### What are coordinate bonds?

- In **simple covalent bonds** the two atoms involved share electrons
- Some molecules have a **lone** pair of electrons that can be donated to form a bond with an **electron-deficient** atom
  - An electron-deficient atom is an atom that has an **unfilled outer orbital**
- So **both electrons** are from the **same atom**
- This type of bonding is called **dative covalent bond** or **coordinate bond**
- An example of a dative bond is in an **ammonium ion**
  - The hydrogen ion,  $H^+$  is **electron-deficient** and has space for two electrons in its shell
  - The nitrogen atom in ammonia has a lone pair of electrons which it can donate to the hydrogen ion to form a coordinate bond

#### Dative covalent bonding ammonium ion

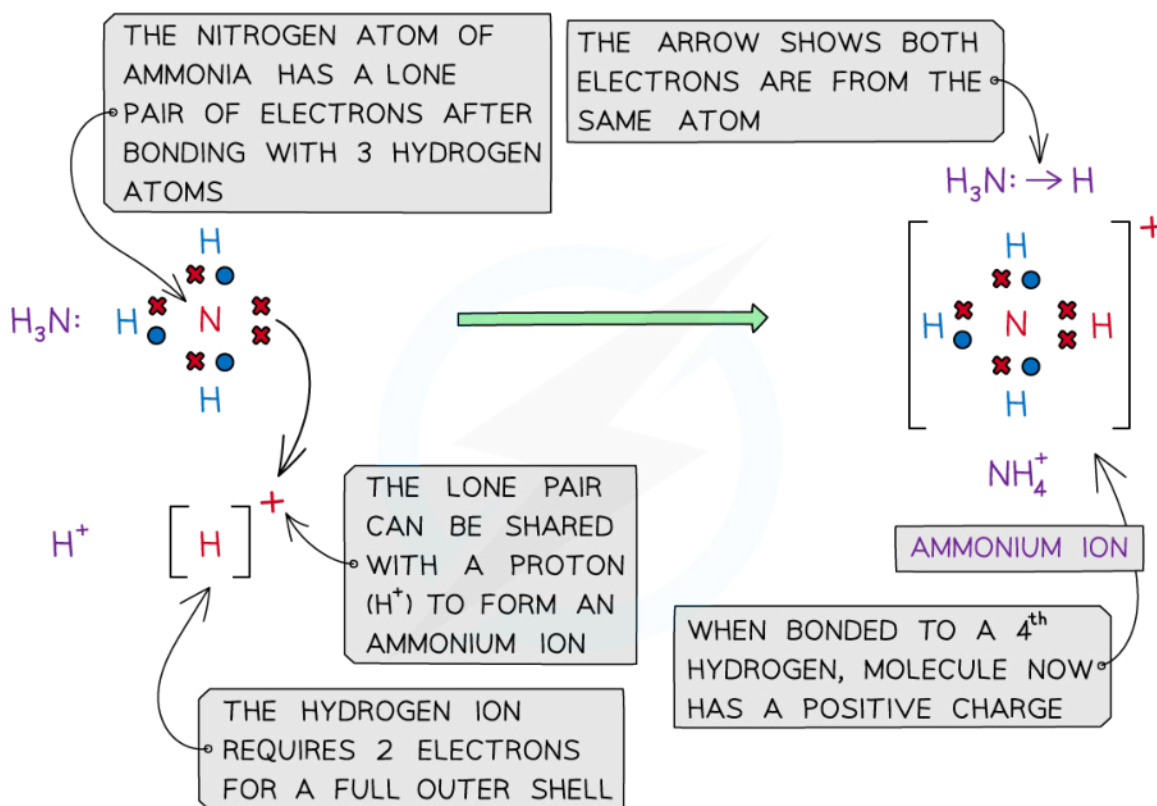

Copyright © Save My Exams. All Rights Reserved

*Ammonia ( $\text{NH}_3$ ) can donate a lone pair to an electron-deficient proton ( $\text{H}^+$ ) to form a charged ammonium ion ( $\text{NH}_4^+$ )*

- More examples of coordinate bonding can be found in the section on **Lewis Structures**

### **Examiner Tip**

Coordinate bonds are also referred to as coordination bonds or dative covalent bonds.



Your notes



Your notes

## Shapes of Molecules

### Shapes of Molecules

#### What is Valence Shell Electron Pair Repulsion Theory?

- When an atom forms a covalent bond with another atom, the electrons in the different bonds and the non-bonding electrons in the outer shell all behave as negatively charged clouds and repel each other
- In order to minimise this repulsion, all the outer shell electrons spread out as far apart in space as possible
- Molecular shapes and the angles between bonds can be predicted by the **valence shell electron pair repulsion theory** known by the abbreviation **VSEPR** theory
- VSEPR** theory consists of three basic rules:
  - All electron pairs and all lone pairs arrange themselves as far apart in space as is possible.
  - Lone pairs repel more strongly than bonding pairs.
  - Multiple bonds behave like single bonds
- These three rules can be used to predict the shape of any covalent molecule or ion, and the angles between the bonds
- The regions of negative cloud charge are known as **domains** and can have one, two or three pairs electrons

#### Two electron domains

- If there are two electron domains on the central atom, the angle between the bonds is  $180^\circ$
- Molecules which adopt this shape are said to be **LINEAR**
- Examples of linear molecules include  $\text{BeCl}_2$ ,  $\text{CO}_2$ , and  $\text{HC}\equiv\text{CH}$

#### Diagram to show molecules with two electron domains

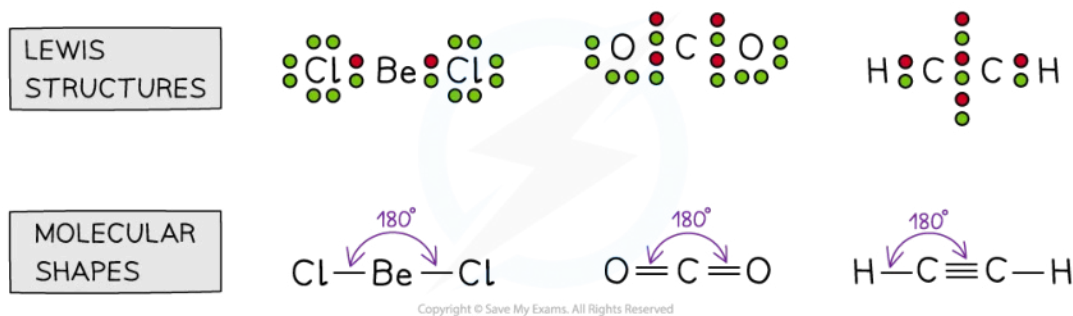

*Beryllium chloride, carbon dioxide and ethyne all have two electron domains*

#### Three electron domains

- If there are three electron domains on the central atom, the angle between the bonds is  $120^\circ$
- Molecules which adopt this shape are said to be **TRIANGULAR PLANAR** or **TRIGONAL PLANAR**

- Examples of three electron domains which are all bonding pairs include  $\text{BF}_3$  and  $\text{CH}_2\text{CH}_2$  and  $\text{CH}_2\text{O}$

### Diagram to show molecules with three electron domains

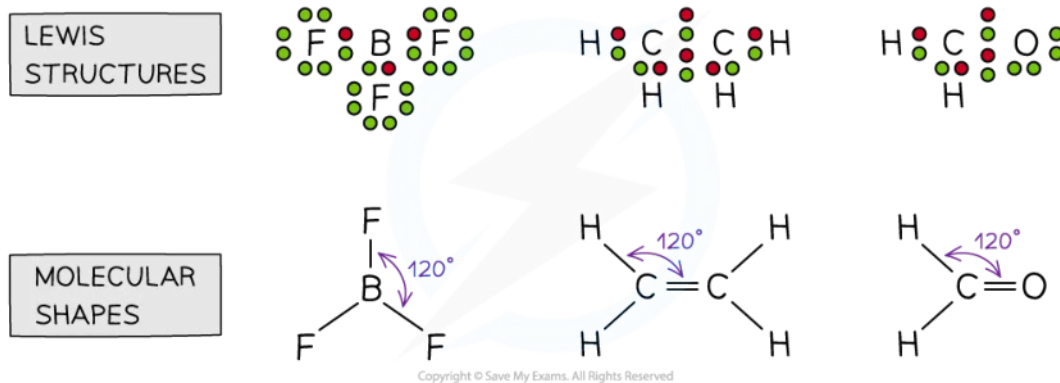

**Boron trifluoride, ethene and methanal all have three electron domains**

- If one of these electron domains is a lone pair, the bond angle is slightly less than  $120^\circ$  due to the stronger repulsion from lone pairs, forcing the bonding pairs closer together. E.g.  $\text{SO}_2$
- The bond angle is approximately  $\sim 118^\circ$

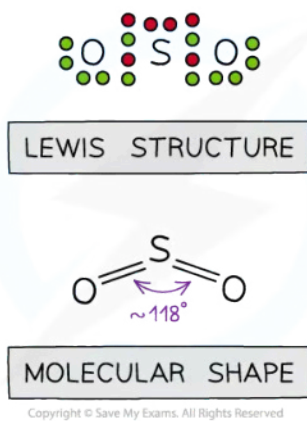

### The shape of sulfur dioxide

- Sulfur dioxide is an example of a molecule that '**expands the octet**' as you will see there are 10 electrons around the sulfur atom which is possible for 3rd period elements and above
- This shape is no longer called triangular planar as the shape names are only based on the atoms present, this molecule is **BENT LINEAR**

### Four electron domains



Your notes

- If there are four electron domains on the central atom, the angle between the bonds is approx  $109^\circ$ .  
E.g.  $\text{CH}_4$ ,  $\text{NH}_4^+$
- Molecules which adopt this shape are said to be **TETRAHEDRAL**



Your notes

**Diagram to show molecules with four electron domains**

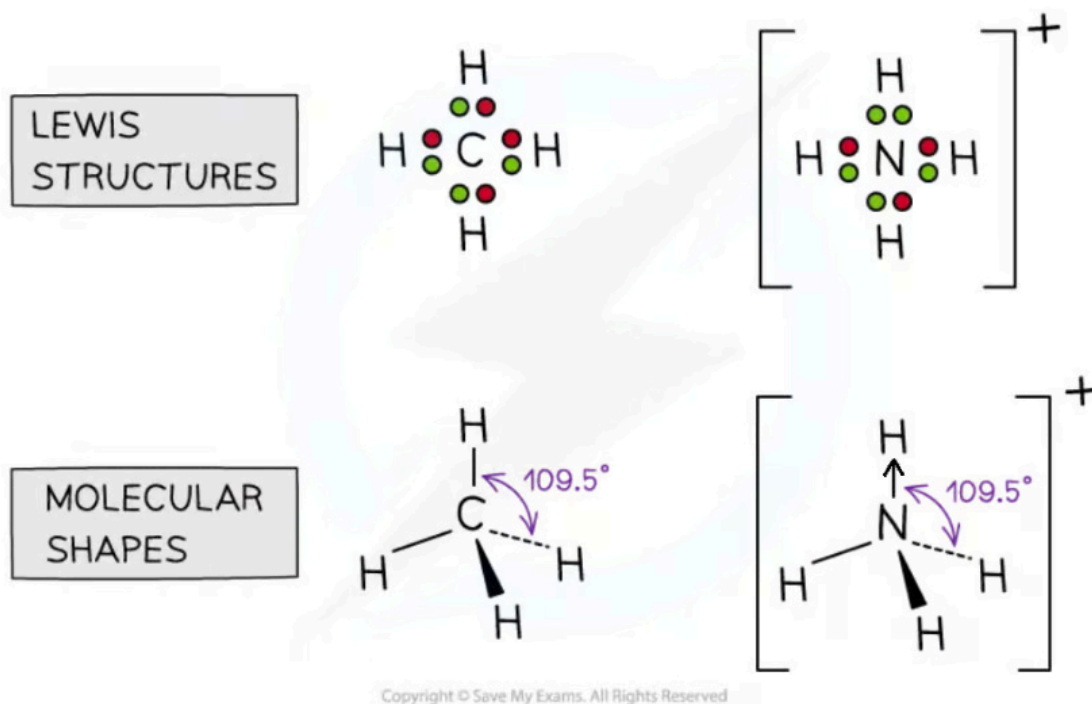

**Methane and ammonium ions have four electron domains**

- If one of the electron domains is a lone pair, the bond angle is slightly less than  $109^\circ$ , due to the extra lone pair repulsion which pushes the bonds closer together (approx  $107^\circ$ ). E.g.  $\text{NH}_3$ ,

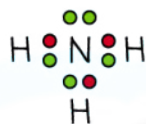

LEWIS STRUCTURE

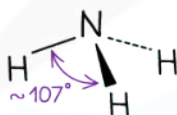

MOLECULAR SHAPE

Copyright © Save My Exams. All Rights Reserved

### *The shape of ammonia*

- Molecules which adopt this shape are said to be **TRIANGULAR PYRAMIDAL** or **TRIGONAL PYRAMIDAL**
- If two of the electron domains are lone pairs, the bond angle is also slightly less than  $109^\circ$ , due to the extra lone pair repulsion (approx  $104^\circ$ ). E.g.  $\text{H}_2\text{O}$
- Molecules which adopt this shape are said to be **BENT** or **ANGULAR** or **BENT LINEAR** or **V-shaped** (when viewed upside down)

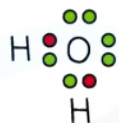

LEWIS STRUCTURE



MOLECULAR SHAPE

Copyright © Save My Exams. All Rights Reserved

### *The shape of water*

- Lone pairs are pulled more closely to the central atoms so they exert a greater repulsive force than bonding pairs

## Diagram to show repulsion between different electron pairs

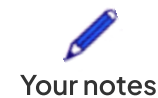
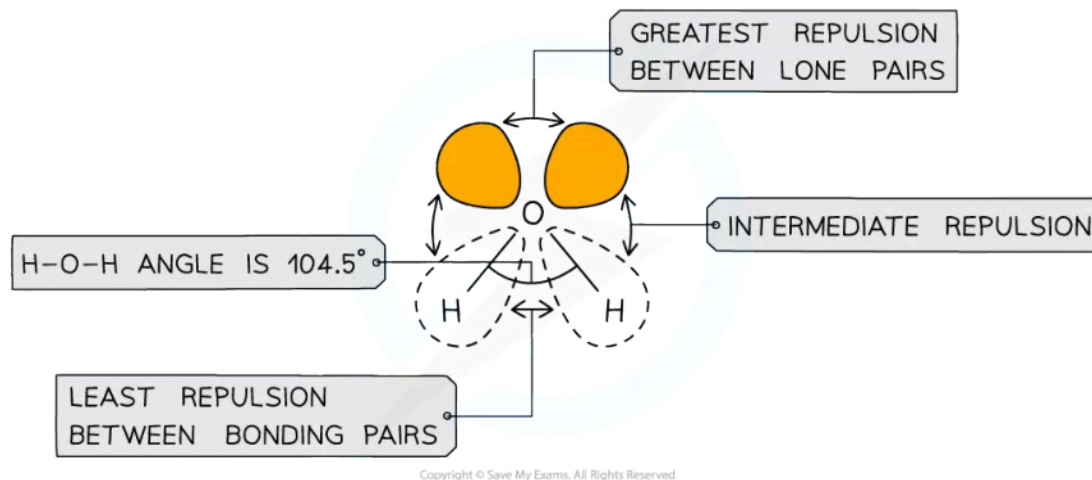

The order of electron pair repulsion is lone pairs > lone pair: bonding pair > bonding pairs

## Summary table of electron domains and molecular shapes

- These are the domains and molecular geometries you need to know for Standard Level:

Bonding pairs	Lone pairs	Total pairs	Domain geometry	Molecular geometry	Bond angle
2	0	2	linear	linear	180°
3	0	3	trigonal planar	trigonal planar	120°
2	1	3	trigonal planar	bent linear	118°
4	0	4	tetrahedral	tetrahedral	109.5°
3	1	4	tetrahedral	trigonal pyramid	107°
2	2	4	tetrahedral	bent linear	104.5°



 **Examiner Tip**

Be careful to distinguish between molecular shape and electron domain shape as it can be easy to confuse the two. Sometimes they are the same as is the case of methane, but other times they can be different like ammonia which has a tetrahedral domain shape, but triangular pyramid molecular shape. Always draw the Lewis structure before you attempt to deduce the shape and bond angle as you could easily miss some lone pairs



Your notes



Your notes

## Bond Polarity

### Bond Polarity

#### What is electronegativity?

- **Electronegativity** refers to the ability of an atom to draw an electron pair towards itself in a covalent bond
- Different atoms have different electronegativities, shown by the **Pauling scale** below
- The higher the value, the more electronegative the element is

#### The Pauling Scale

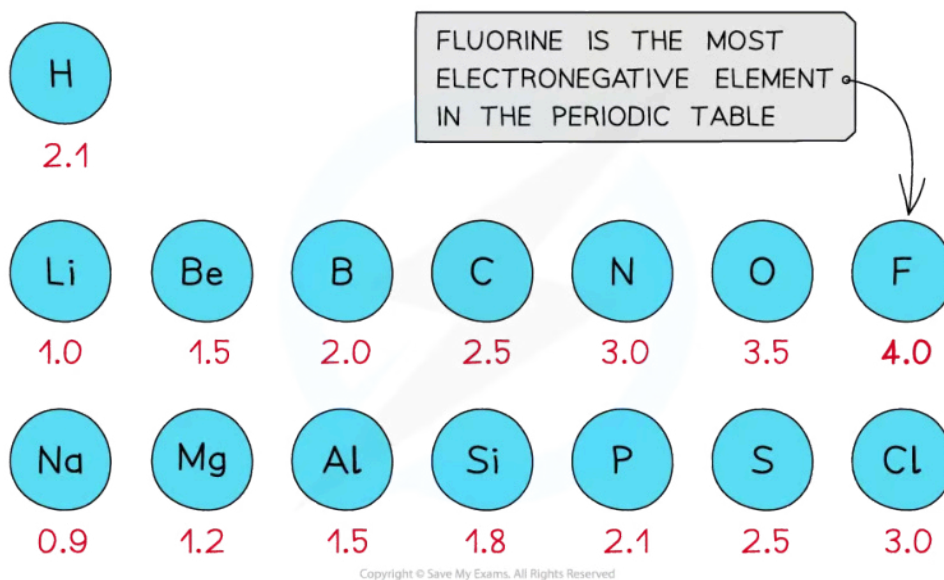

#### First three rows of the periodic table showing electronegativity values

- In **diatomic molecules** the electron density is shared equally between the two atoms
  - Eg.  $H_2$ ,  $O_2$  and  $Cl_2$
- Both atoms have the electronegativity value and have an **equal attraction** for the bonding pair of electrons leading to formation of a **covalent** bond
- The covalent bond is **nonpolar**

#### Diagram to show the electron distribution in a chlorine molecule

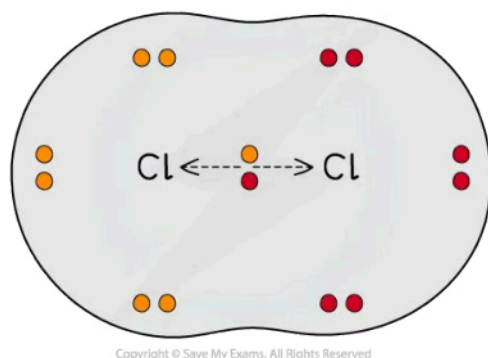

*The two chlorine atoms have identical electronegativities so the bonding electrons are shared equally between the two atoms and the bond is nonpolar*

## What is meant by a polar bond?

- When two atoms in a covalent bond have **different electronegativities** the covalent bond is **polar** and the electrons will be drawn towards the **more electronegative** atom
- As a result of this:
  - The negative charge centre and positive charge centre do not **coincide** with each other
  - This means that the **electron distribution is asymmetric**
  - The **less electronegative** atom gets a partial charge of  $\delta+$  (**delta positive**)
  - The **more electronegative** atom gets a partial charge of  $\delta-$  (**delta negative**)
- The extent of polarity in a covalent bond varies, depending on how big a **difference** exists in the electronegativity values of the two bonded atoms
  - The bigger the difference in electronegativity, the higher the polarity of the covalent bond

### Diagram to show the electron distribution in an HCl molecule

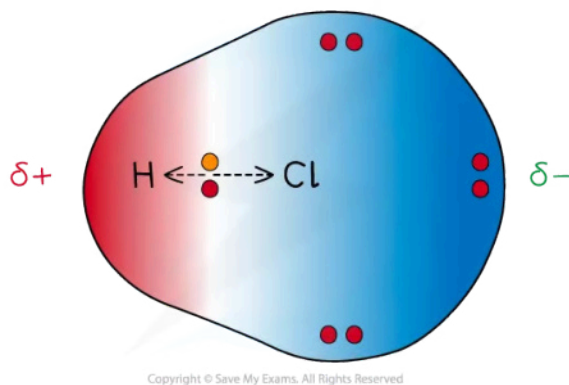

*Cl has a greater electronegativity than H causing the electrons to be more attracted towards the Cl atom which becomes delta negative and the H delta positive*



Your notes

## What is a dipole?

- The **dipole moment** is a measure of how **polar** a bond is
- The **direction** of the dipole moment is shown by the following sign in which the **arrow** points to the **partially negatively charged end** of the dipole:



*The sign shows the direction of the dipole moment and the arrow points to the delta negative end of the dipole*

### Worked example

The electronegativity values of four elements are given.

$$\text{C} = 2.6 \quad \text{N} = 3.0 \quad \text{O} = 3.4 \quad \text{F} = 4.0$$

What is the order of **increasing** polarity of the **bonds** in the following compounds?

- A.  $\text{CO} < \text{OF}_2 < \text{NO} < \text{CF}_4$
- B.  $\text{NO} < \text{OF}_2 < \text{CO} < \text{CF}_4$
- C.  $\text{CF}_4 < \text{CO} < \text{OF}_2 < \text{NO}$
- D.  $\text{CF}_4 < \text{NO} < \text{OF}_2 < \text{CO}$

**Answer:**

- The correct option is **B** because:
  - You have to calculate the difference in electronegativity for the bonds and then rank them from smallest to largest:

$$\text{NO} (3.4 - 3.0 = \mathbf{0.4})$$

$$\text{OF}_2 (4.0 - 3.4 = \mathbf{0.6})$$

$$\text{CO} (3.4 - 2.6 = \mathbf{0.8})$$

$$\text{CF}_4 (4.0 - 2.6 = \mathbf{1.4})$$



Your notes

## Molecular Polarity

### Molecular Polarity

- To determine whether a molecule with **more than two atoms** is polar, the following things have to be taken into consideration:
  - The polarity of each bond within the molecule
  - How the bonds are arranged in the molecule (i.e the geometry of the molecule)
- Some molecules have **polar bonds** but are overall not **polar** because the polar bonds in the molecule are arranged in such way that the individual dipole moments **cancel each other out**

#### A polar molecule

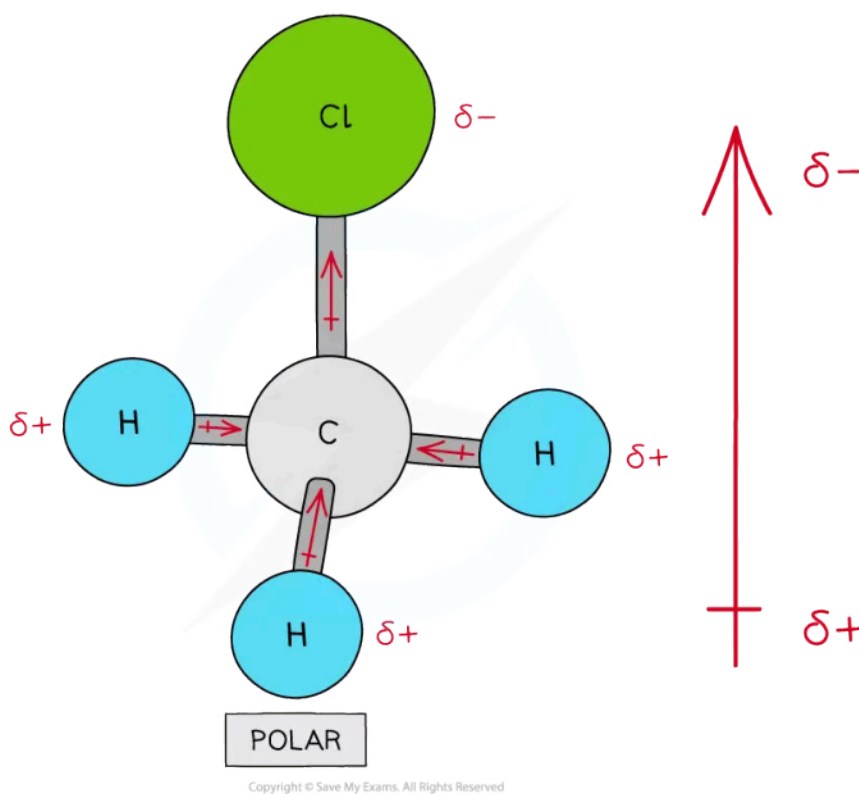

*There are four polar covalent bonds in  $\text{CH}_3\text{Cl}$  which do not cancel each other out causing  $\text{CH}_3\text{Cl}$  to be a polar molecule; the overall dipole is towards the electronegative chlorine atom*

#### A nonpolar molecule



Your notes

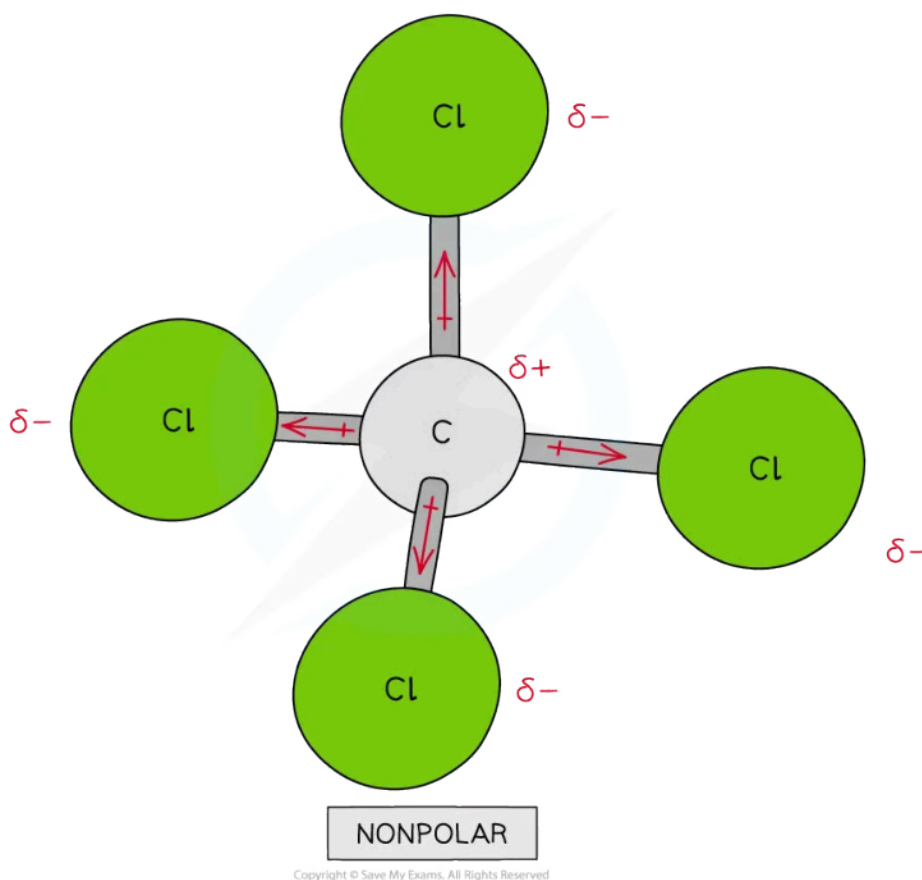

*Though  $\text{CCl}_4$  has four polar covalent bonds, the individual dipole moments cancel each other out causing  $\text{CCl}_4$  to be a nonpolar molecule*

 **Examiner Tip**

When the pulls of the atoms are not equal and opposite, there is a net pull so the molecule is polar.



Your notes

## Giant Covalent Structures

### Giant Covalent Structures

#### Covalent lattices

- **Covalent bonds** are bonds between nonmetals in which electrons are **shared** between the atoms
- In some cases, it is not possible to satisfy the bonding capacity of a substance in the form of a molecule; the bonds between atoms continue indefinitely, and a large lattice is formed. There are no individual molecules and covalent bonding exists between all adjacent atoms
- Such substances are called **giant covalent substances**, and the most important examples are C and SiO<sub>2</sub>
- Graphite, diamond, buckminsterfullerene and graphene are allotropes of carbon

#### Diamond

- Diamond is a giant lattice of carbon atoms
- Each carbon is covalently bonded to four others in a tetrahedral arrangement with a bond angle of 109.5°
- The result is a giant lattice with strong bonds in all directions
- Diamond is the hardest substance known
  - For this reason it is used in drills and glass-cutting tools

Diagram to show the tetrahedral structure of diamond

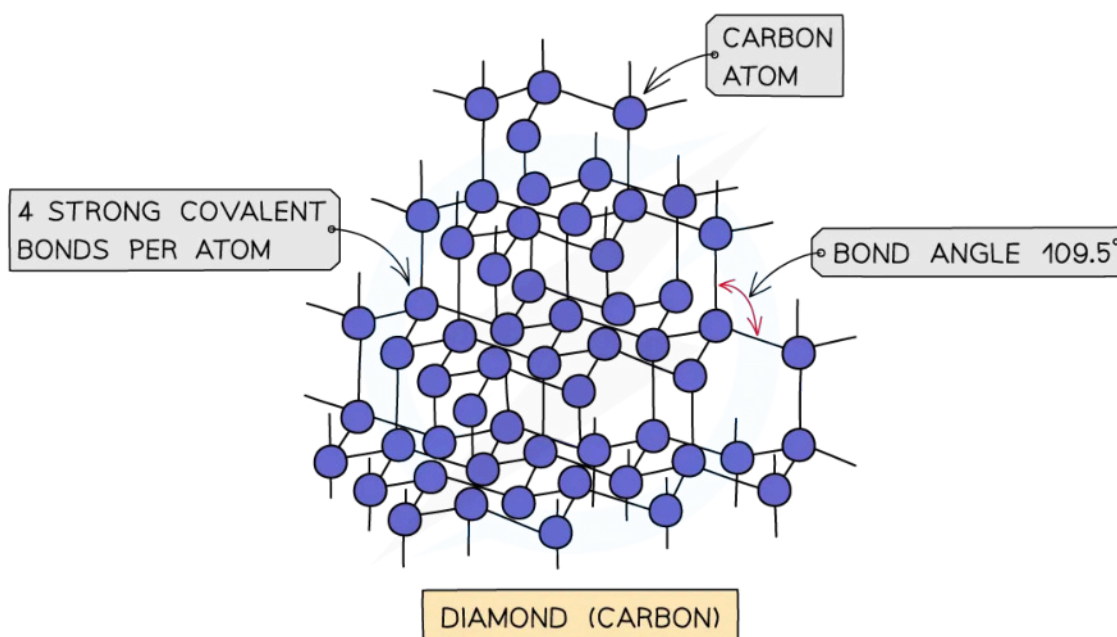

Copyright © Save My Exams. All Rights Reserved



Your notes

*The structure of diamond*

## Graphite

- In graphite, each carbon atom is bonded to three others in a layered structure
- The layers are made of hexagons with a bond angle of  $120^\circ$
- The spare electron is delocalised and occupies the space in between the layers
- All atoms in the same layer are held together by strong covalent bonds, and the different layers are held together by weak intermolecular forces

**Diagram to show the layered structure of graphite**

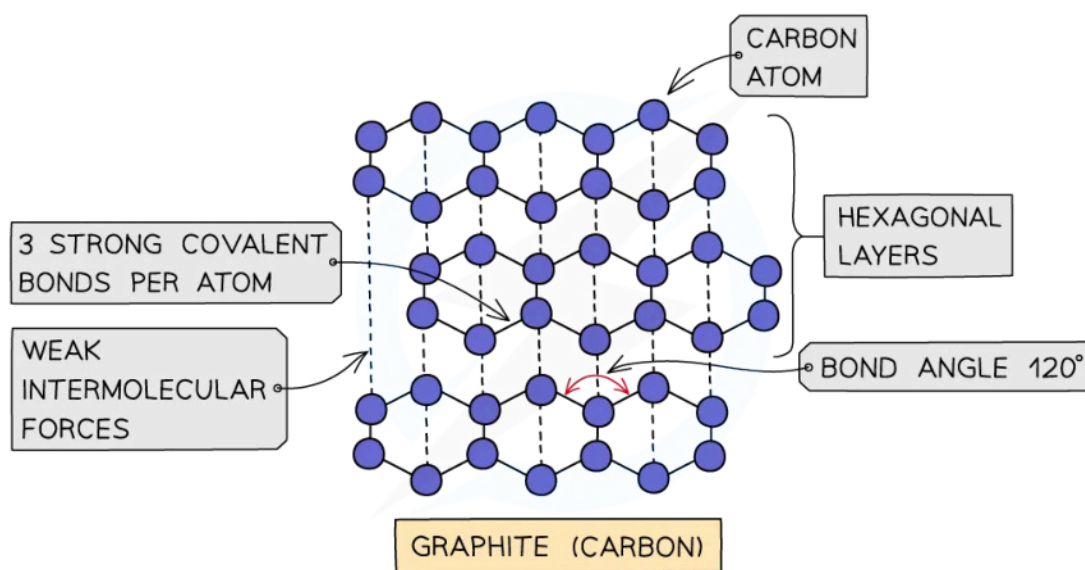

*The structure of graphite*

## Buckminsterfullerene

- **Buckminsterfullerene** is one type of fullerene, named after Buckminster Fuller, the American architect who designed domes like the Epcot Centre in Florida
- It contains 60 carbon atoms, each of which is bonded to three others by single covalent bonds
- The fourth electron is delocalised so the electrons can migrate throughout the structure making the buckyball a semi-conductor
- It has exactly the same shape as a soccer ball, hence the nickname the football molecule

**Diagram to show the interlocking hexagons and pentagons that make up the structure of Buckminsterfullerene**



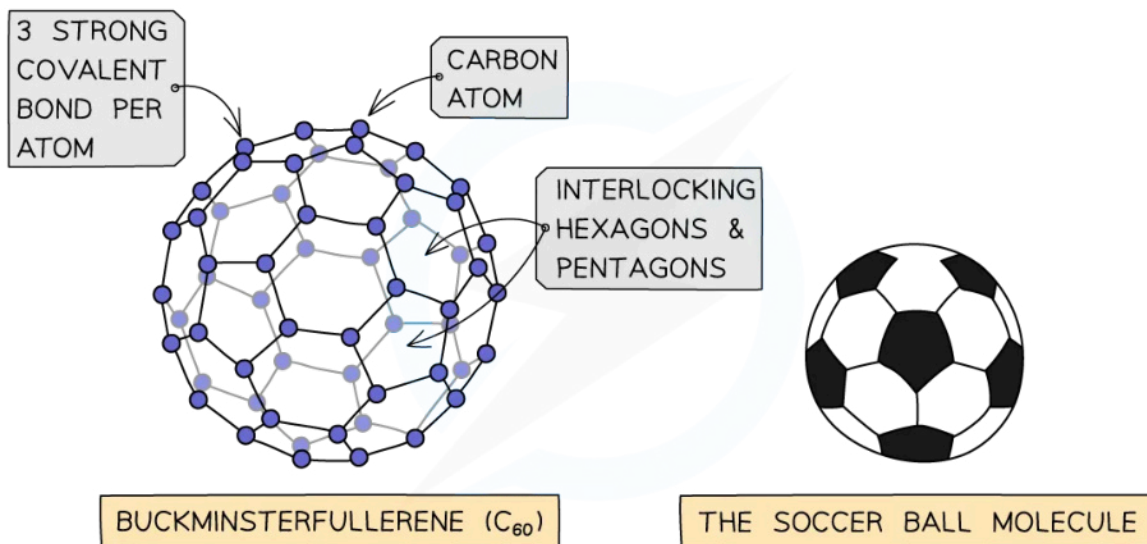

Copyright © Save My Exams. All Rights Reserved

**The structure of buckminsterfullerene**

**Graphene**

- Some substances contain an infinite lattice of covalently bonded atoms in two dimensions only to form layers. Graphene is an example
- Graphene is made of a single layer of carbon atoms that are bonded together in a repeating pattern of hexagons
- Graphene is one million times thinner than paper; so thin that it is actually considered two dimensional

**Diagram to show the two dimensional structure of graphene**

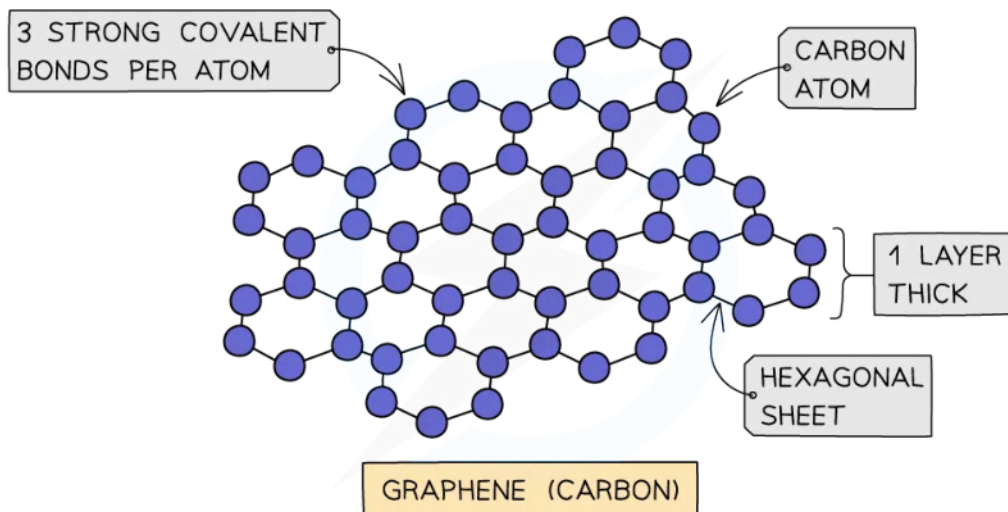

Copyright © Save My Exams. All Rights Reserved



Your notes

*The structure of graphene*

**Silicon**

- The silicon atoms in silicon have a tetrahedral arrangement, just like that of the carbon atoms in diamond
- Each silicon atom is covalently bonded to four other silicon atoms
- Silicon has a giant lattice structure

**Diagram to show the tetrahedral arrangement in silicon**

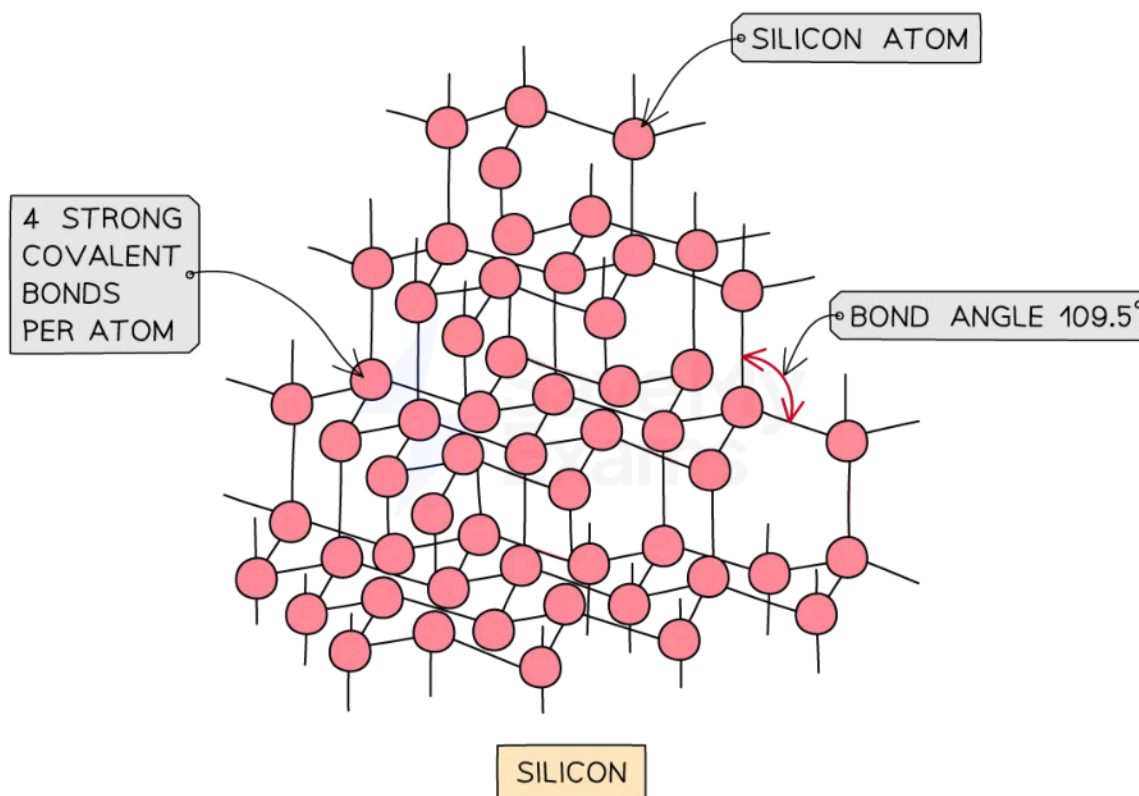

Copyright © Save My Exams. All Rights Reserved

*The structure of silicon*

**Silicon(IV) oxide**

- Silicon(IV) oxide is also known as silicon dioxide, but you will be more familiar with it as the white stuff on beaches!
- Silicon(IV) oxide adopts the same structure as diamond - a giant structure made of tetrahedral units all bonded by strong covalent bonds
- Each silicon is shared by four oxygens and each oxygen is shared by two silicon atoms
- This gives an empirical formula of  $\text{SiO}_2$

**Diagram to show the tetrahedral units in silicon(IV) oxide**



Your notes

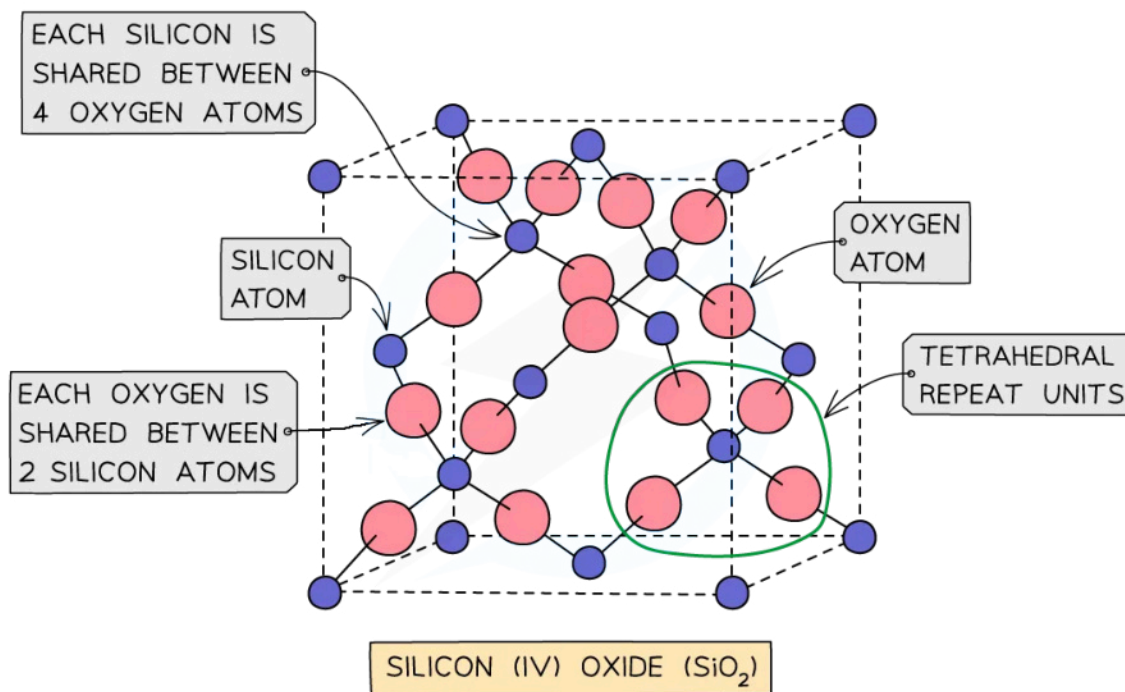

*The structure of silicon dioxide*

## Properties of Giant Covalent Structures

- Different types of **structure** and **bonding** have different effects on the **physical properties** of substances such as their **melting** and **boiling points**, **electrical conductivity** and **solubility**
- **Giant covalent lattices** have very high **melting** and **boiling points**
  - These compounds have a large number of **covalent bonds** linking the whole structure
  - A lot of energy is required to break the lattice
- The compounds can be **hard** or **soft**
  - Graphite is **soft** as the forces between the carbon layers are weak
  - Diamond and silicon(IV) oxide are **hard** as it is difficult to break their 3D network of strong covalent bonds
  - Graphene is strong, flexible and transparent which it makes it potentially a very useful material
- Most compounds are insoluble with water
- Most compounds do not **conduct electricity** however some do
  - Graphite has **delocalised** electrons between the carbon layers which can move along the layers when a voltage is applied
  - Graphene is an excellent conductors of electricity due to the **delocalised** electrons
  - Buckminsterfullerene is a semi-conductor

- Diamond and silicon(IV) oxide do not conduct electricity as all four outer electrons on every carbon atom is involved in a **covalent bond** so there are no free electrons available

### Characteristics of Giant Covalent Structures Table

	Diamond	Graphite	Graphene	Buckminsterfullerene	Silicon	Silicon dioxide
Melting and boiling point	Very high	Very high	Very high	Low	High	Very high
Appearance	Transparent crystal	Grey solid	Transparent	Black powder	Grey-white solid	Transparent crystals
Electrical conductivity	Non-conductor	Good	Very good	Poor	Poor	Non-conductor
Thermal conductivity	Good	Poor	Very good	Poor	Good	Good
Other properties	Hardest known natural substance	Soft and slippery	Thinnest and strongest material to exist	Light and strong	Good mechanical strength	Piezoelectric – produces electric charge from mechanical stress



Your notes

#### Examiner Tip

Although buckminsterfullerene is included in this section it is not classified as a giant structure as it has a fixed formula,  $C_{60}$ .

## Intermolecular Forces



Your notes

### Intermolecular Forces

- There are no covalent bonds between molecules in molecular covalent compounds. There are, however, forces of attraction between these molecules, and it is these which must be overcome when the substance is melted and boiled
- These forces are known as **intermolecular forces**
- There are three main types of **intermolecular forces**:
  - London (dispersion) forces
  - Dipole-dipole attraction
  - Hydrogen bonding

### London (dispersion) forces

- The electrons in atoms are not static; they are in a state of constant motion
  - It is therefore likely that at any given time the distribution of electrons will not be exactly symmetrical - there is likely to be a slight surplus of electrons on one side of the atoms

**Diagram to show how London (dispersion) forces arise**

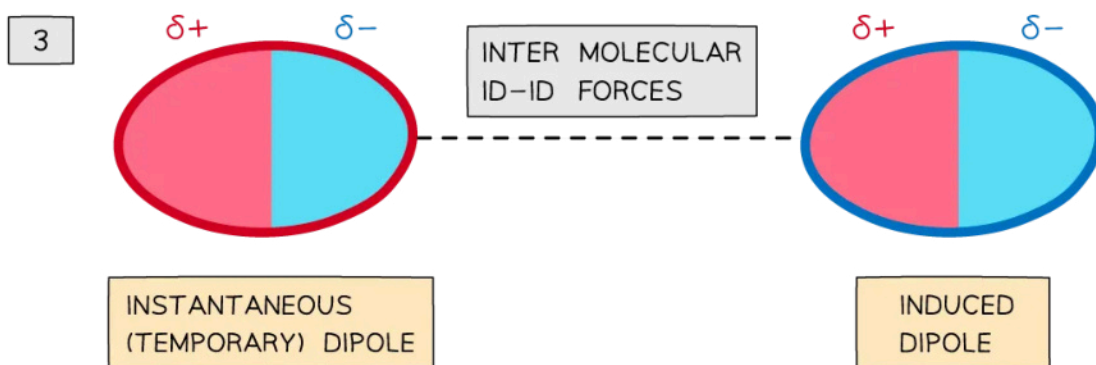
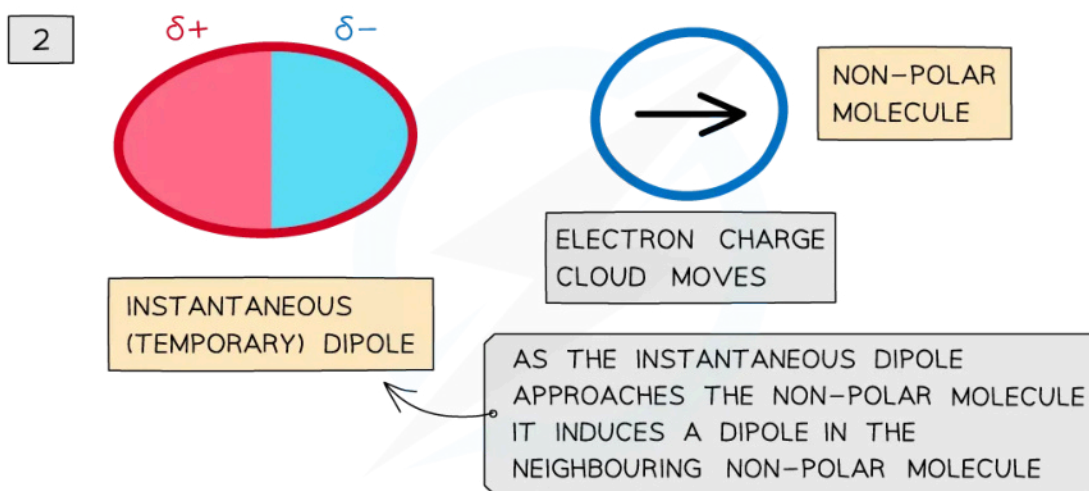
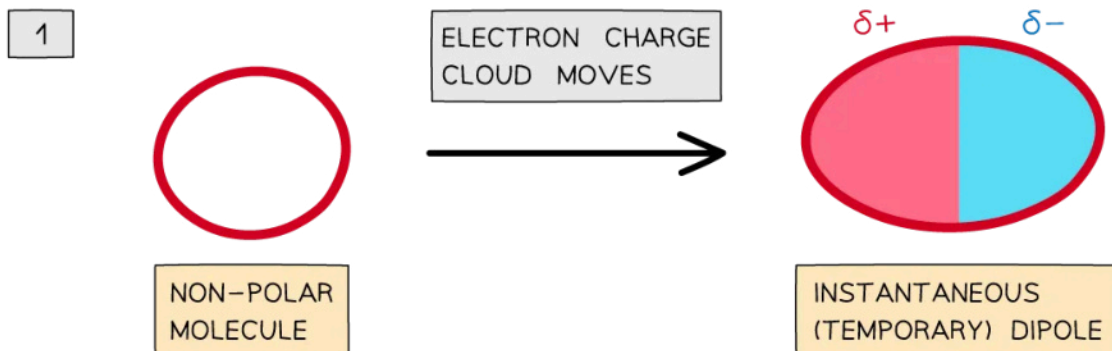

Copyright © Save My Exams. All Rights Reserved

### London (Dispersion) forces

- This is known as a **temporary dipole**
  - It lasts for a very short time as the electrons are constantly moving

- **Temporary dipoles** are constantly appearing and disappearing
- Consider now an adjacent atom. The electrons on this atom are repelled by the negative part of the dipole and attracted to the positive part and move accordingly
- This is a **temporary induced dipole**
  - There is a resulting attraction between the two atoms, and this known as **London (dispersion) forces**, after the German chemist, Fritz London
- **London (dispersion) forces** are present between all atoms and molecules, although they can be very weak
  - They are the reason all compounds can be liquefied and solidified
  - **London (dispersion) forces** tend to have strengths between  $1 \text{ kJmol}^{-1}$  and  $50 \text{ kJmol}^{-1}$ .
- The strength of the **London (dispersion) forces** in between molecules depends on two factors:
  - the number of electrons in the molecule
  - Surface area of the molecules

## Number of electrons

- The greater the number of electrons in a molecule, the greater the likelihood of a distortion and thus the greater the frequency and magnitude of the temporary dipoles
- The dispersion forces between the molecules are stronger and the melting and boiling points are larger
- The enthalpies of vaporisation and boiling points of the noble gases illustrate this factor:

### Graph to show the effect of number of electrons on enthalpy of vaporisation and boiling point



Your notes



Your notes

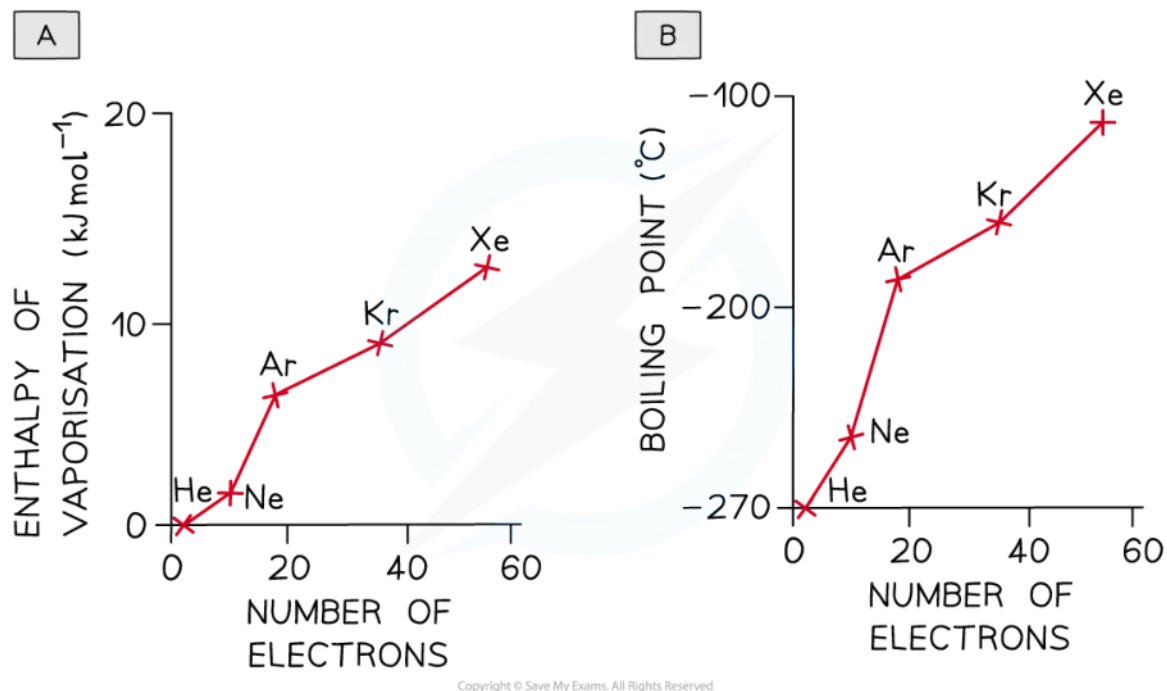

*As the number of electrons increases more energy is needed to overcome the forces of attraction between the noble gases atoms*

## Surface area

- The larger the surface area of a molecule, the more contact it will have with adjacent molecules
- The greater its ability to induce a dipole in an adjacent molecule, the greater the **London (dispersion) forces** and the higher the melting and boiling points
- This point can be illustrated by comparing different isomers containing the same number of electrons:

**Diagram to show the effect of surface area on intermolecular forces**



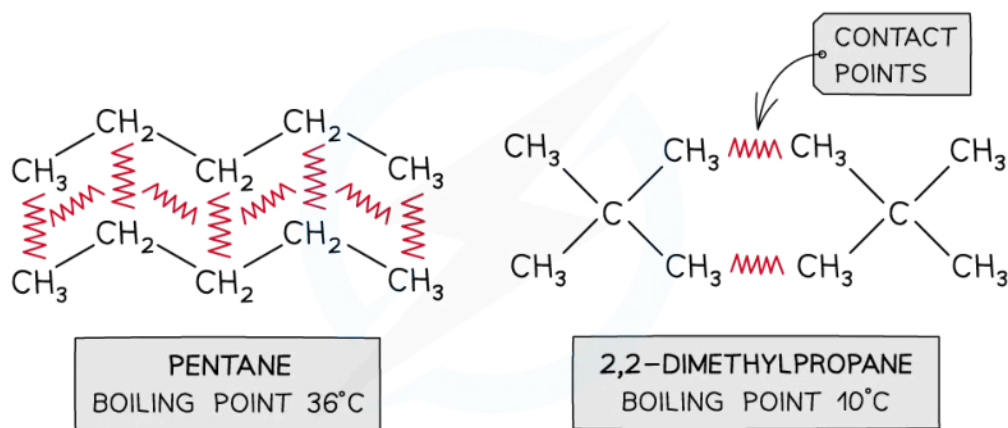

Copyright © Save My Exams. All Rights Reserved

**Boiling points of molecules with the same numbers of electrons but different surface areas**

## Dipole-dipole attractions

- Temporary dipoles exist in all molecules, but in some molecules there is also a **permanent dipole**
- In addition to the **London (dispersion) forces** caused by temporary dipoles, molecules with permanent dipoles are also attracted to each other by **permanent dipole-dipole bonding**

**Diagram to show permanent dipole-dipole interactions**

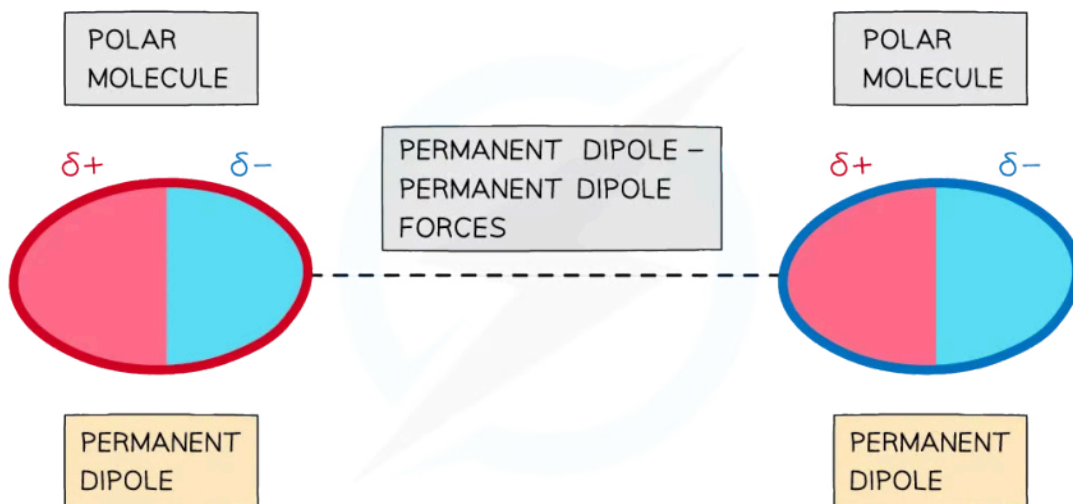

Copyright © Save My Exams. All Rights Reserved

**The delta negative end of one polar molecule will be attracted towards the delta positive end of a neighbouring polar molecule**

- This is an attraction between a **permanent dipole** on one molecule and a **permanent dipole** on another.
- **Dipole-dipole bonding** usually results in the boiling points of the compounds being slightly higher than expected from temporary dipoles alone
  - it slightly increases the strength of the intermolecular attractions
- The effect of **dipole-dipole bonding** can be seen by comparing the melting and boiling points of different substances which should have **London (dispersion) forces** of similar strength

## Comparing butane and propanone

- For small molecules with **the same number of electrons**, **dipole-dipole attractions** are **stronger** than **dispersion forces**
  - Butane and propanone have the same number of electrons
  - Butane is a nonpolar molecule and will have only dispersion forces
  - Propanone is a polar molecule and will have dipole-dipole attractions and dispersion forces
  - Therefore, more energy is required to break the intermolecular forces between propanone molecules than between butane molecules
  - The result is that propanone has a higher boiling point than butane

### Diagram to show the structures of butane and propanone

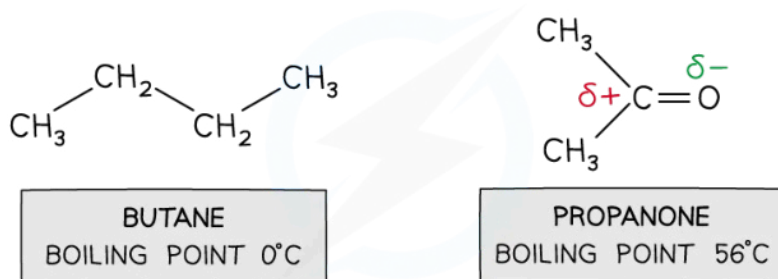

Copyright © Save My Exams. All Rights Reserved

*Comparing substances with permanent and temporary dipoles in smaller molecules with an equal number of electrons*

## Dipole-induced dipole attraction

- Some mixtures might contain both polar and nonpolar molecules, for example HCl and Cl<sub>2</sub>
- The permanent dipole of a polar molecule can cause a temporary separation of charge on a non-polar molecule
- This force is called dipole-induced dipole attraction
- This force acts in addition to the London dispersion forces that occur between nonpolar molecules and the dipole-dipole forces between polar molecules

### Diagram to show dipole-induced dipole attraction

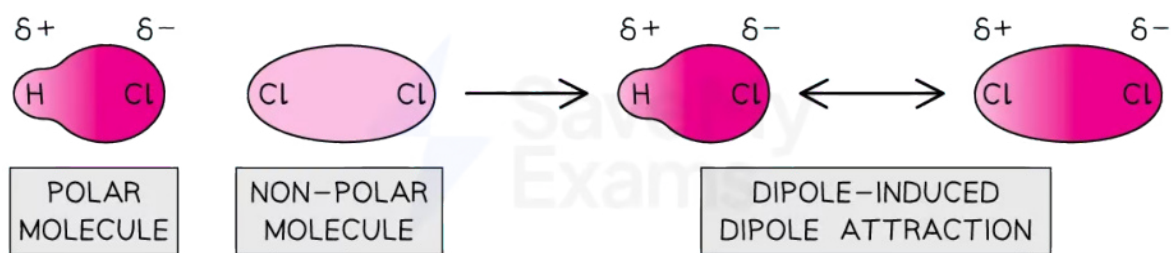

Copyright © Save My Exams. All Rights Reserved

*The polar HCl molecule causes a separation of charge on the nonpolar chlorine molecule*

## Hydrogen bonding

- Hydrogen bonding is the **strongest** type of **intermolecular force**
  - Hydrogen bonding is a special type of **permanent dipole – permanent dipole** bonding
- For hydrogen bonding to take place the following is needed:
  - A species which has an **O** or **N** or **F** (very **electronegative**) atom with an available **lone pair** of electrons
  - A hydrogen attached to the **O, N** or **F**
- When hydrogen is covalently bonded to an **electronegative** atom, such as **O, N** or **F**, the bond becomes very highly **polarised**
- The H becomes so  **$\delta^+$**  charged that it can form a bond with the **lone pair** of an **O, N** or **F** atom in another molecule

### Diagram to show polarisation of the H–O/N/F bond

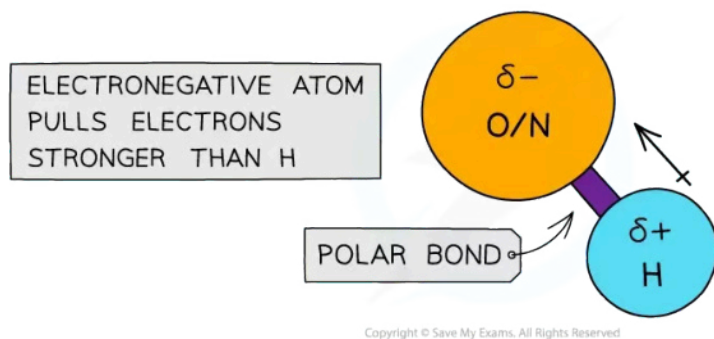

Copyright © Save My Exams. All Rights Reserved

*The electronegative atoms O or N have a stronger pull on the electrons in the covalent bond with hydrogen, causing the bond to become polarised*

- Hydrogen bonds are represented by dots or dashes between H and the N/O/F element
- The number of hydrogen bonds depends on:
  - The number of hydrogen atoms attached to O, N or F in the molecule
  - The number of **lone pairs** on the O, N or F

### Diagram to show hydrogen bonding in ammonia

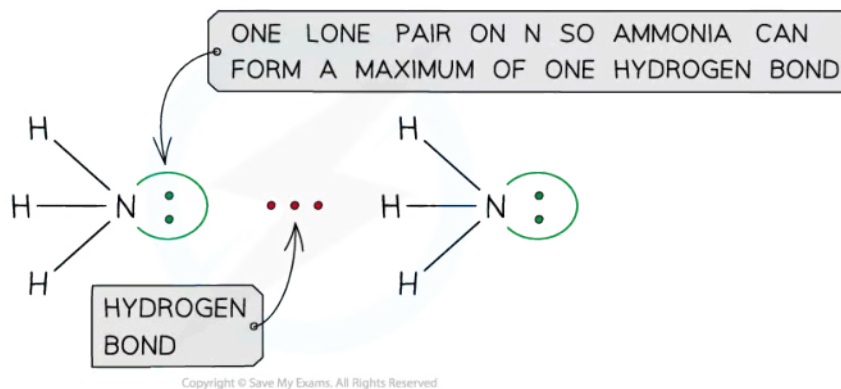

*Ammonia can form a maximum of one hydrogen bond per molecule*

### Diagram to show hydrogen bonding in water

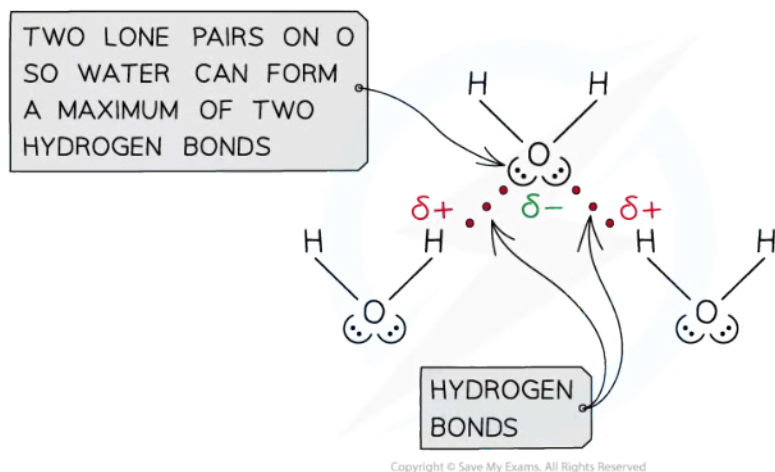

*Water can form a maximum of two hydrogen bonds per molecule*

## Van der Waals' forces

- The term Van der Waal's forces is used to include:
  - London dispersion forces
  - Dipole-induced dipole attractions
  - Dipole-dipole attractions
- These forces occur between molecules (intermolecularly), as well within a molecule (intramolecularly)

### Diagram to show the difference between intermolecular and intramolecular forces

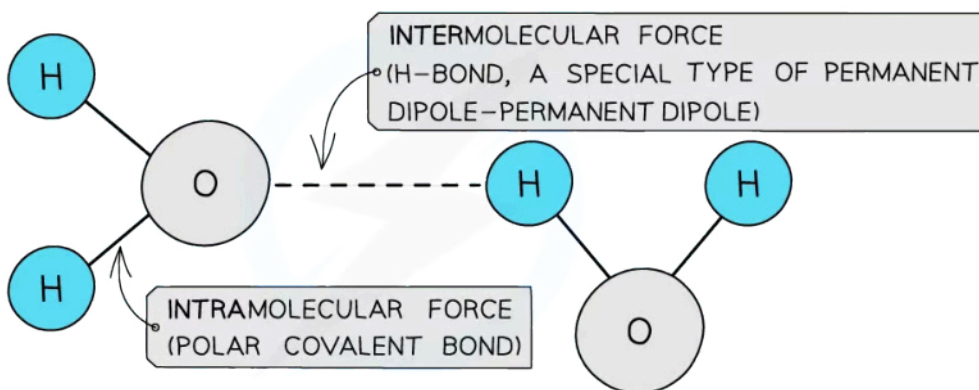

*The polar covalent bonds between O and H atoms are intramolecular forces and the permanent dipole – permanent dipole forces between the molecules are intermolecular forces*

### Examiner Tip

The term “London (dispersion) forces” refers to instantaneous induced dipole induced dipole forces that exist between any atoms or groups of atoms and should be used for non-polar species.



Your notes

## Physical Properties of Covalent Substances

### Physical Properties of Covalent Substances

- The physical properties of **molecular covalent compounds** are largely influenced by their **intermolecular forces**
- If you know the type of **intermolecular forces** present you can predict the physical properties like **melting** and **boiling point**, **solubility**, and **conductivity**

### Melting and boiling point

- When covalent molecular substances change state you are overcoming the **intermolecular forces**
- The stronger the forces the more energy need to break the attraction
- **Intermolecular forces** are much weaker than covalent bonds, so many covalent substances are liquid or gases at room temperature
- Substance with a low melting and boiling point are said to be very **volatile**
- The strength of the intermolecular forces increases with
  - the **size** of the molecule
  - the increase in the **polarity** of the molecule
  - Drawing the structure of the molecule helps identify and rank molecules according to boiling point as the following example shows

### Worked example

Place these three molecules in the correct order from lowest to highest boiling point and explain your reasoning:

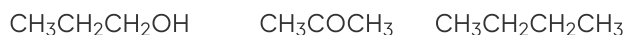

**Answer:**

- **Step 1:** The first thing to do is find the approximate relative molecular mass:

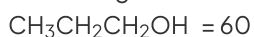

This tells you the molecules are approximately the same size so the dispersion forces will be similar

- **Step 2:** Draw the structures of the molecules and identify the intermolecular forces present

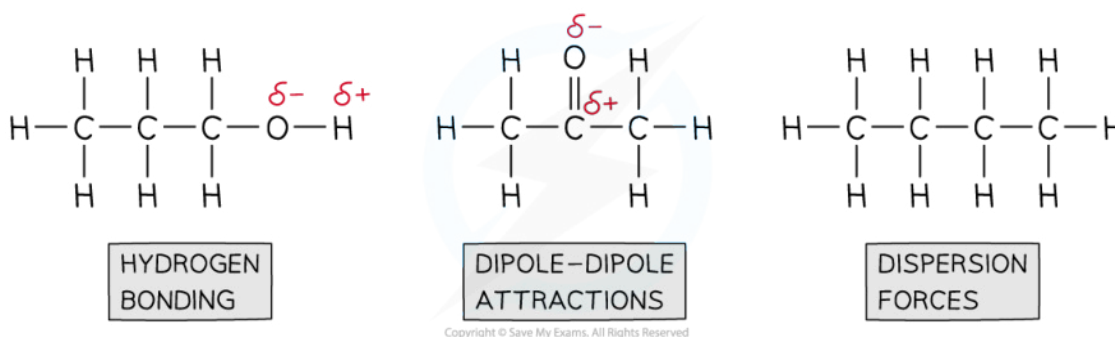

So, the order of boiling from lowest to highest is:



### Solubility

- The general principle is that 'like dissolves like' so non-polar substances mostly dissolve in non-polar solvents, like hydrocarbons and they form dispersion forces between the solvent and the solute
- Polar covalent substances generally dissolve in polar solvents as a result of dipole-dipole interactions or the formation of hydrogen bonds between the solute and the solvent
- A good example of this is seen in organic molecules such as alcohols and water:

**Diagram to show the hydrogen bonding between ethanol and water**

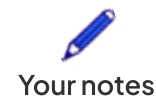
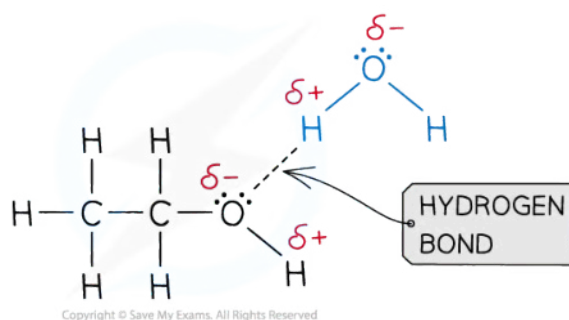

**A hydrogen bond forms between oxygen atom on the ethanol and the hydrogen atom of the water**

- As covalent molecules become larger their solubility can decrease as the polar part of the molecule is only a smaller part of the overall structure
  - This effect is seen in alcohols for example where ethanol,  $C_2H_5OH$ , is readily soluble but hexanol,  $C_6H_{13}OH$ , is not
- Polar covalent substances are unable to dissolve well in non-polar solvents as their dipole-dipole attractions are unable to interact well with the solvent
- Giant covalent substances generally don't dissolve in any solvents as the energy needed to overcome the strong covalent bonds in the lattice structures is too great

## Conductivity

- As covalent substances do not contain any freely moving charged particles they are unable to conduct electricity in either the solid or liquid state
- However, under certain conditions some polar covalent molecules can ionise and will conduct electricity
- Some giant covalent structures are capable of conducting electricity due to delocalised electrons but they are exceptions to the general rule

**Comparing the Properties of Covalent Compounds Table**

	Non-polar covalent substances	Polar covalent substances	Giant covalent substances	Ionic substances
Melting and boiling point	Low	Low	Very high	Very high
Volatility	Highest	High	Low	Low
Solubility in polar solvents	Insoluble	Some solubility depending on	Insoluble	Soluble





Your notes

		molecular size		
Solubility in non-polar solvents	Soluble	Some solubility depending on molecular size	None	Insoluble
Electrical conductivity	None	None	None – except graphite, graphene	Only when molten or aqueous

### Worked example

Compound **X** has the following properties:

Melting point	Electrical conductivity	
1450°C	solid	molten
	poor	poor

What is the most probable structure of **X**?

- A. Network covalent
- B. Polar covalent molecule
- C. Ionic lattice
- D. Metallic lattice

**Answer:**

- The correct option is **A** because:
  - A high melting point is characteristic of a giant structure, which could be metallic, ionic or covalent
  - The poor conductivity as a liquid and solid would match a giant covalent or network covalent structure



Your notes

## Chromatography

### Chromatography

#### What is chromatography?

- Chromatography is a separation technique that enables the separation of mixtures and includes:
  - paper chromatography
  - thin-layer chromatography (TLC)
- These chromatography techniques make use of the principle that components in a mixture when dissolved in a fluid (**mobile phase**), will flow through another material (**stationary phase**) at varying rates
- The rate of separation depends upon how the components in the mixture interact with the stationary phase (their **retention**) and how soluble they are in the mobile phase
- Therefore the rate of separation depends on the intermolecular forces present

For more information on performing chromatography and other separation techniques, see our revision notes on [separating mixtures](#)

#### Examiner Tip

- Column chromatography (CC) and gas chromatography (GC), sometimes called gas-liquid chromatography (GLC), are other chromatographic techniques you may see in other resources
- They also work on the same principles as paper chromatography and TLC but with different stationary and mobile phases.
  - These are beyond the scope of this specification.

#### What is paper chromatography?

- In paper chromatography, the mobile phase is a **solvent**, and the stationary phase is the **chromatography paper**
- A **pencil line** is drawn on chromatography paper, this is the **baseline** (or origin), and spots of the sample are placed on it
  - Pencil is used for this as ink would run into the chromatogram along with the samples
- The paper is then lowered into the solvent container, making sure that the pencil line sits **above** the level of the solvent so the samples don't wash into the solvent container
- The solvent travels up the paper by capillary action, taking the sample with it
- As the solvent moves up the paper, the components in the mixture are dissolved to different extents depending on their **solubility**, so will travel with the solvent at different rates
  - The extent of solubility depends on the **intermolecular forces** present
- The paper contains cellulose fibres which have hydroxyl (OH) groups along their structure
- Substances in the mixture that can form **hydrogen bonds** with the OH groups will be more attracted to the stationary phase than those which form weaker intermolecular forces
  - This attraction to the stationary phase also affects the rate of separation

- Once the solvent front almost reaches the top of the paper, the paper is removed from the solvent and the solvent front is marked on the paper
- The separated components will appear as distinct spots on the paper

### Paper chromatography

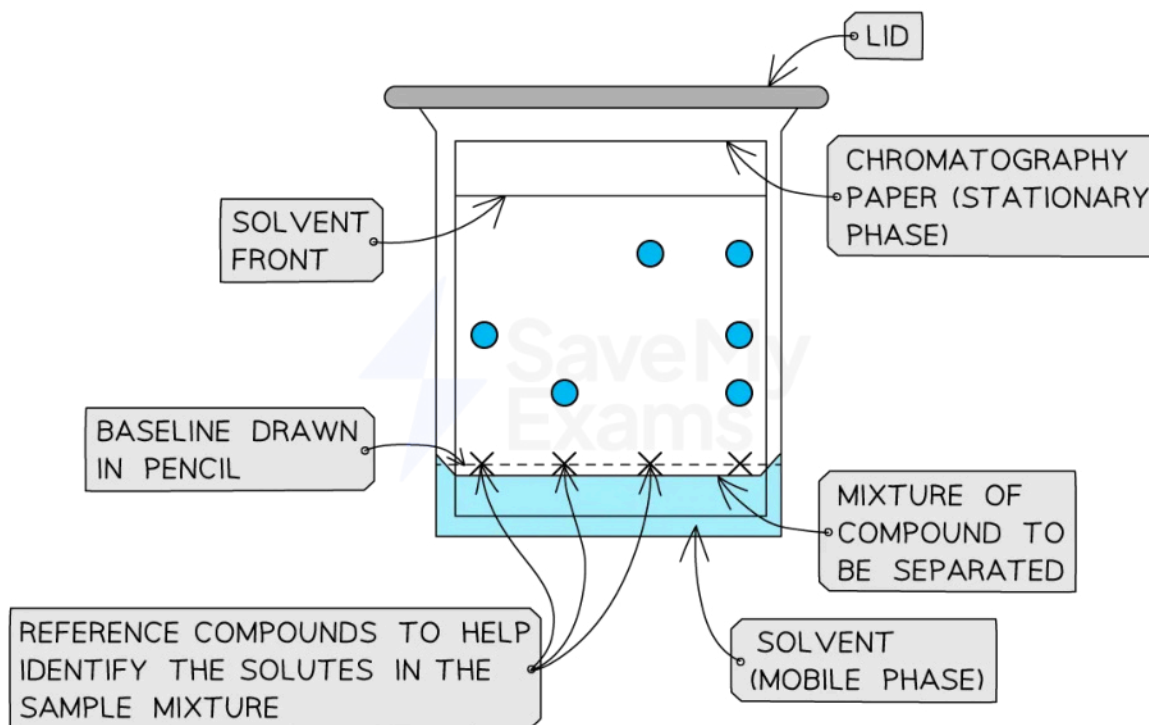

*A dot of the sample is placed on the baseline and allowed to separate as the mobile phase flows through the stationary phase; the reference compound/s will also move with the solvent and are used to identify the components in the mixture.*

#### Examiner Tip

- If the sample does not travel with the solvent, it is because it is insoluble in that solvent
- An alternative solvent should be used
- Sometimes a number of solvents need to be trialled in order to find a suitable one in which the components of the sample are separated sufficiently

### What is thin layer chromatography (TLC)?

- TLC works in a similar way to paper chromatography but has a different stationary phase
- The **stationary phase** is a thin layer of an inert substance (e.g. **silica** or **alumina**) supported on a flat, unreactive surface (e.g. **glass**)
- The **mobile phase**, like paper chromatography, is a **solvent**



Your notes

- Silica and alumina contain OH groups so can form hydrogen bonds with components in the sample
- The components are **adsorbed** onto the surface of the stationary phase
- Depending on the strength of interactions with the stationary phase, the separated components will travel particular distances through the plate

### What are retardation factors ( $R_f$ ) values?

- The extent of separation of the component molecules in the investigated sample depends on their solubility in the mobile phase and the extent of adhesion to the stationary phase
- The  $R_f$  value is used to quantify the distance a particular component travels relative to the solvent front
- $R_f$  values for compounds are calculated using measurements from the paper chromatogram or TLC plate and can be calculated using the  $R_f$  equation:

$$R_f = \frac{\text{distance travelled by component}}{\text{distance travelled by solvent}}$$

- These values can be used alongside other analytical data to deduce the composition of mixtures

### Calculation of $R_f$ values

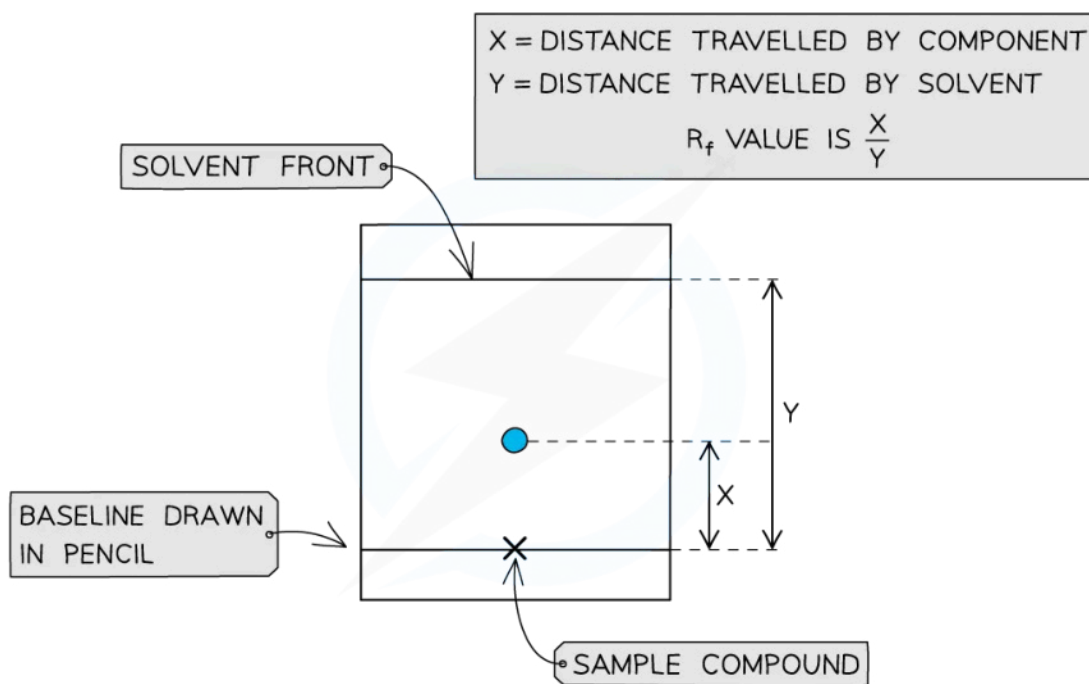

*$R_f$  values can be calculated by taking 2 measurements from a chromatogram*

### Examiner Tip

- $R_f$  values are quoted as decimals and have no units as they are a ratio of distances
  - When you divide two lengths measured in the same unit, those units cancel out, leaving you with a unitless number.
- $R_f$  values will always be less than 1 as the component cannot travel further than the solvent front!



Your notes