

Structured Questions

Work, Energy & Power

Principle of Conservation of Energy / Sankey Diagrams / Work Done / Kinetic Energy / Gravitational Potential Energy / Elastic Potential Energy / Conservation of Mechanical Energy / Energy & Power / Efficiency Formula / Energy Density

Easy (5 questions)	/64
Medium (5 questions)	/60
Hard (5 questions)	/52
Total Marks	/176

Scan here to return to the course
or visit [savemyexams.com](https://www.savemyexams.com)

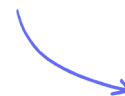

Easy Questions

1 (a) A toy company are investigating the workings behind several types of toys.

Select, by placing a tick (✓) in the correct box, the main form of energy used by each toy.

Toy	Kinetic Energy	Gravitational Potential Energy	Elastic Potential Energy
A catapult			
An action figure falling using a parachute			
A wind-up bouncing rabbit			
A train moving along a train track			

.....

.....

.....

.....

(4 marks)

(b) The catapult from part (a) is undergoing testing. The spring constant of the elastic band in the catapult is 92 N m^{-1} . In one test the band is extended by 0.3 m.

Calculate the elastic potential energy stored in the elastic band of the catapult.

.....

.....

(2 marks)

- (c)** An action figure from part (a) of mass 250 g is dropped from a height of 5 m.

Calculate the gravitational potential energy of the action figure in this experiment.

(3 marks)

- (d)** A new type of pushchair for dolls is being developed. In one round of testing a pushchair has a force of 20 N applied for a distance of 5 m at an angle of 45° to the horizontal.

Calculate the work done on the pushchair.

(2 marks)

- 2 (a)** At an athletics training camp, runners are being tested for their speed, efficiency and power. A runner with a mass of 52 kg manages to maintain a constant velocity of 7 m s^{-1} .

Calculate the kinetic energy of the runner.

(2 marks)

- (b)** The runner from part (a) runs for 12 seconds.

Calculate her power.

(3 marks)

- (c)** At the training camp runners are kept on a strict diet to maximise performance.

Identify the following types of energy:

- (i) The energy stored in the athlete's muscles. [1]
- (ii) Two forms of wasted energy transfer produced from the stored energy above. [2]

(3 marks)

- (d) Runners are also analysed for their efficiency. The same runner from parts (a) and (b) eats an energy bar that provides 800 000 J of energy.

Calculate the efficiency of her run assuming that all the energy from the bar is transferred to her body for use on the run.

(2 marks)

3 (a) The rising price of petrol is inspiring car companies to produce more efficient electric models.

Identify by placing a tick (✓) in the correct boxes the useful and wasted energy transferred from the chemical reaction happening inside a petrol car.

Energy type	Useful	Wasted
Sound		
Thermal		
Electrical		
Kinetic		

.....

.....

.....

.....

(4 marks)

(b) Some energy within a system is stored and some is transferred.

Place a tick (✓) in the correct box to identify whether the following energy types are stores or transfers.

Energy type	Transfer	Store
Chemical		
Nuclear		
Sound		
Light		
Kinetic		
Internal		
Elastic		
Gravitational potential		
Electrical		

.....

.....

.....

.....

.....

.....

.....

.....

.....

.....

(9 marks)

- (c) Driving safety organisations are worried that electric cars are more powerful than petrol or diesel cars causing them to be very dangerous.

In a test drive, the thrust from an electric car engine is 200 N when the car maintains a constant speed of 27 m s^{-1} .

Calculate the power of the car.

.....

..... (2 marks)

(d) State:

(i) Whether electric or petrol cars have more wasted energy. [1]

(ii) Two types of wasted energy in a car energy system. [2]

.....

.....

..... (3 marks)

4 (a) Astronauts are in training for a planned mission to land on the surface of Jupiter.

Identify, by placing a tick (✓) in the box(es), which of the following tasks will be more difficult to carry out due to the larger acceleration of free fall on Jupiter.

Task	More difficult
Throwing a ball up from the surface	
Driving a car along the surface	
Stretching a spring whilst setting up a tent	
Launching a rocket from the surface	

.....
.....
(2 marks)

(b) A ball is dropped from a height of 2 m towards the surface of Jupiter. The acceleration of free fall on Jupiter is 24.58 m s^{-2} .

Calculate the speed of the ball just as it hits the surface. Assume that no energy is lost to the surroundings.

- (i) State the relationship, in symbols, between gravitational potential energy at the point the ball is dropped from and the kinetic energy just before it hits the surface [1]
- (ii) Rearrange the relationship found in part (i) to obtain an equation for v , the speed of the ball when it hits the surface [1]
- (iii) Hence, calculate v [1]

.....
.....
(3 marks)

- (c) The mass of the rocket upon its launch from Jupiter is 18×10^6 kg. It takes 300 seconds to travel the 3.0 km to the edge of Jupiter's atmosphere.

Calculate:

- (i) The weight of the rocket. [2]
- (ii) The minimum power required by the rocket to leave the surface of Jupiter. [3]

(5 marks)

- (d) Astronauts have developed special tents with stiff springs to erect on the surface of Jupiter. The springs hang freely vertically with one end fixed to the tent and the other with a mass secured.

Label the diagram below to show the spring when the gravitational potential energy (ΔE_p), kinetic energy (E_k) and elastic potential energy (E_p) are each at their maximum.

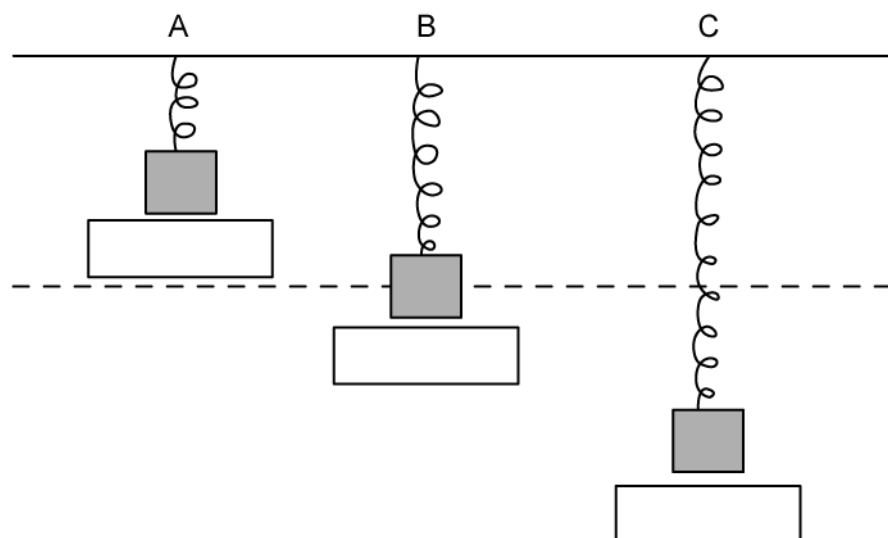

(3 marks)

- 5 (a)** A violin maker is conducting materials testing on various new strings. The first string has a spring constant of $23\,000\text{ N m}^{-1}$ and is extended by 0.06 m before it breaks.

Calculate the force applied to the string just before it breaks.

(3 marks)

- (b)** The string has a mass of $1.97 \times 10^{-4}\text{ kg}$. When the string breaks, assume all elastic potential energy is transferred to kinetic energy.

Calculate the speed of the string upon breaking.

(4 marks)

- (c)** The force-extension graph of a different string is shown below.

Identify the elastic limit and breaking point by labelling the graph.

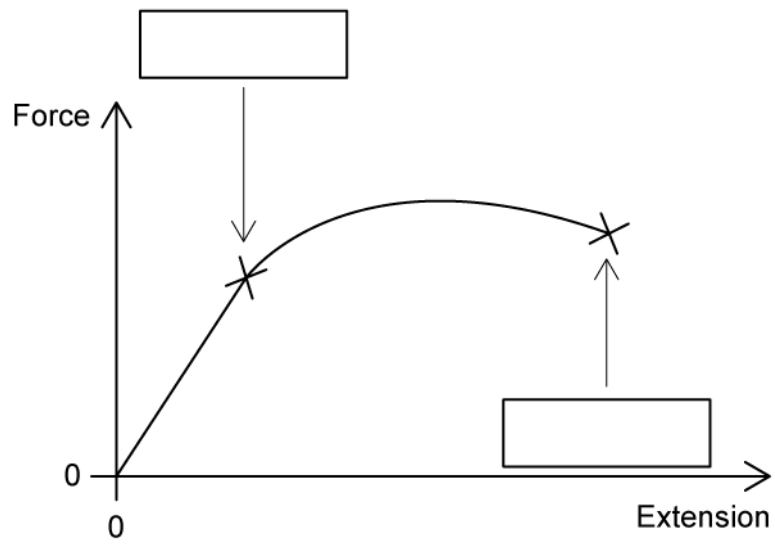

.....

.....

(2 marks)

(d) Calculate the work done on the string up to the elastic limit.

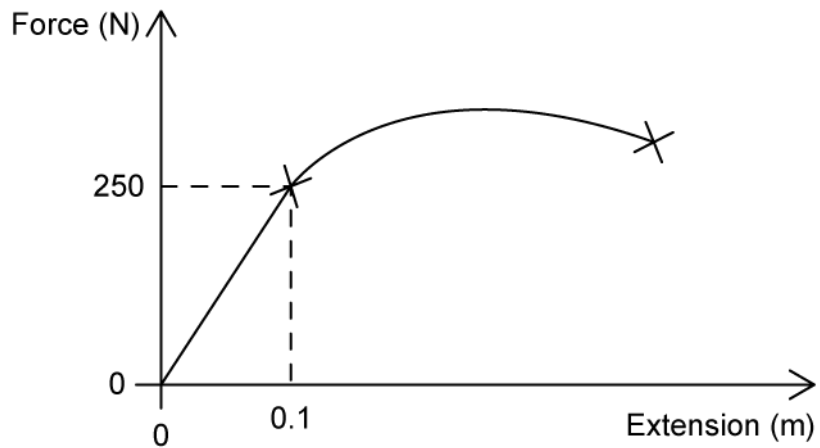

.....

.....

.....

(3 marks)

Medium Questions

1 (a) A box of mass 5.8 kg with initial speed 7.2 m s^{-1} begins to move up a smooth incline.



The box is momentarily brought to rest after colliding with a spring of spring constant 210 N m^{-1} . It stops a vertical distance of 0.65 m above its initial position.

- (i) Calculate the initial energy of the box
- (ii) Determine an equation for the final energy of the box when it collides with the spring

.....

.....

.....

.....

(4 marks)

(b) Hence, or otherwise, calculate the amount by which the spring is compressed.

.....

.....

.....

(3 marks)

- (c) There is now a constant frictional force of 16 N opposing the motion of the box as it moves along the slope uphill part of its path. The incline is at an angle of 22° from the horizontal.

Calculate the magnitude of the work done on the box as it travels uphill.

(3 marks)

- (d) Hence, or otherwise, calculate the new amount by which the spring is compressed.

(3 marks)

2 (a) Some cargo ships use kites working together with the ship's engines to move the vessel.

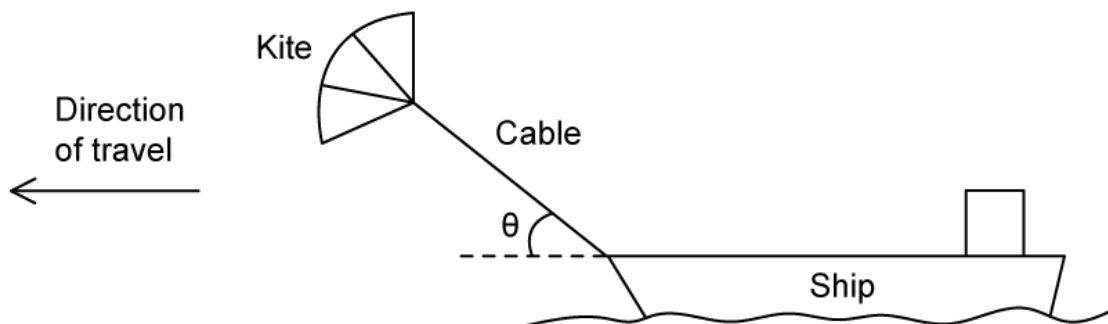

The tension in the cable that connects the kite to the ship is 350 kN. The kite is pulling the ship at an angle of θ to the horizontal. The ship travels at a steady speed of 3.9 m s^{-1} when the ship's engines operate with a power output of 5.7 MW.

Calculate the angle θ if the work done on the ship by the kite when the ship travels for 5 minutes, before the engines are cut off, is 355 MJ.

.....

.....

.....

(3 marks)

(b) When the ship is travelling at 3.9 m s^{-1} , calculate the power that the kite provides.

.....

.....

.....

(3 marks)

(c) Hence calculate the percentage of the total power required by the ship that the kite provides.

.....

.....

(3 marks)

- (d)** The kite is taken down and no longer produces a force on the ship. The resistive force F that opposes the motion of the ship is related to the speed v of the ship by

$$F = kv$$

where k is a constant.

Show that, if the power output of the engines remains at 5.7 MW, the speed of the ship will decrease to about 3.5 m s^{-1} . Assume that k is independent of whether the kite is in use or not.

(3 marks)

3 (a) The arrangement shown below is used to test golf club heads.

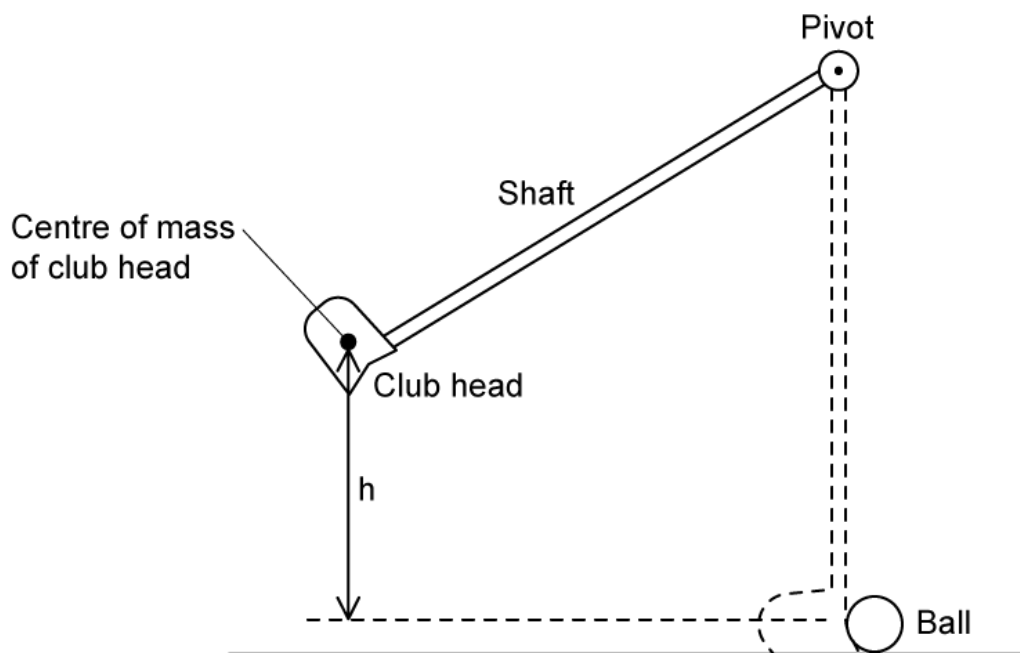

The shaft of a club is pivoted and the centre of mass of the club head is raised by a height h before being released. The club head then falls back to the vertical position where it strikes the ball.

Calculate the maximum speed of the club head achieved when $h = 75$ cm.

.....

.....

.....

(3 marks)

(b) Explain why, in reality, the speed of the ball will not be the same as the maximum speed of the club head.

.....

.....

.....

(3 marks)

- (c) The optimal launch angle for a projectile, such as a golf ball, is 45° . Another experiment is carried out with a golf club that has a shaft 1.14 m long.

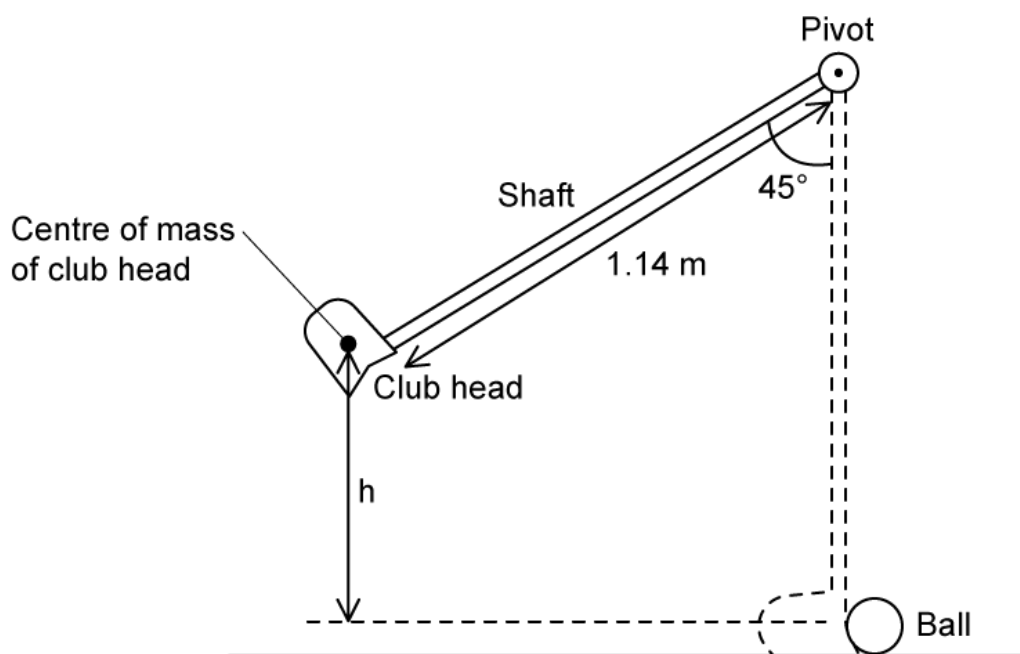

Calculate the maximum speed this club head achieves just before it hits the ball.

(3 marks)

- (d) The golf club head has a mass of 200 g and has a power of 460 mW just before it hits the ball.

Show that time taken for the golf club swing is about 1.4 s.

(3 marks)

- 4 (a)** A motor is used to lift a 50 kg mass from rest up a vertical distance of 18 m in 0.3 minutes.

Calculate the minimum power requires to the lift the mass.

(2 marks)

- (b)** Explain why the power calculated in (a) is a minimum value.

(2 marks)

- (c)** A different motor is used to lift an identical mass through the same distance in the same amount of time with an overall efficiency of 38 %. The mass experiences a resistive force of 170 N.

Calculate the work required from the motor.

(3 marks)

- (d)** Hence, determine the average power input to the motor.

(3 marks)

- 5 (a)** The top speed of a car with a mass of 1400 kg whose engine is delivering 490kW of power is 530 km h^{-1} .

Calculate the force from the engine on the car.

Assume that air resistance is negligible.

(3 marks)

- (b)** The car now travels at a new constant velocity up a hill of incline 25° .

Determine the decrease in velocity from the previous motion of the car as it travels up the hill with the same power.

(4 marks)

- (c)** The car engine cuts off whilst travelling up the incline.

Assuming there are no resistive forces, calculate the distance travelled by the car from when the engine cuts off to when it has a gravitational potential energy of 110 kJ.

(3 marks)

(d) A spring in the car's suspension system has the following force–displacement graph.

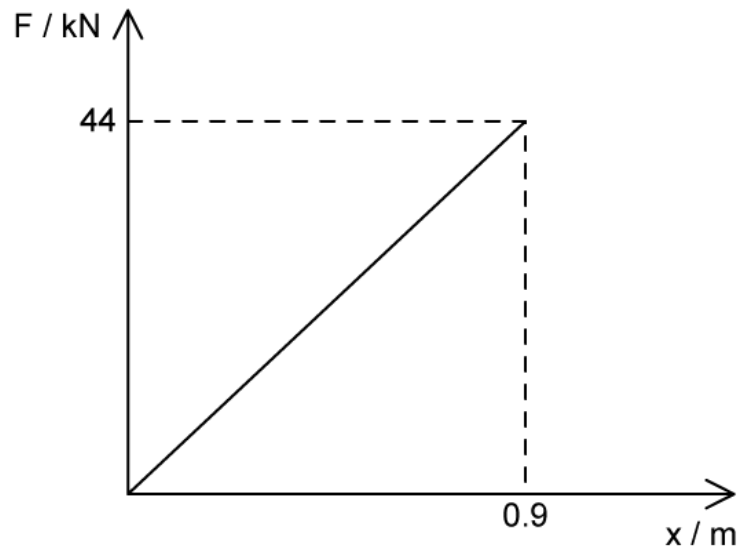

Using the area under the graph, show that the spring constant of the spring is about 49 kN m^{-1} .

(3 marks)

Hard Questions

- 1 (a) A packing company have a contraption involving an inclined plane and a spring. It is used to pack and seal their boxes.

A box of mass 4800 g with an initial speed 21.96 km h^{-1} begins to move up a smooth incline.



The box is momentarily brought to rest after colliding with a spring of spring constant 195 N m^{-1} . It stops a vertical distance of 230 mm above its initial position.

Calculate the compression of the spring in mm.

(3 marks)

- (b) On a different set up, the inclined plane is rough and has a coefficient of friction of 0.3. A new box comes to rest part way up the slope after 2.12 seconds.

Determine the height the box reaches at the point it comes to rest.

You may use the result:

$$\tan \theta = \frac{\sin \theta}{\cos \theta}$$

(4 marks)

- 2 (a) Some cargo ships use kites together with the ships engine to move heavy pieces of cargo.

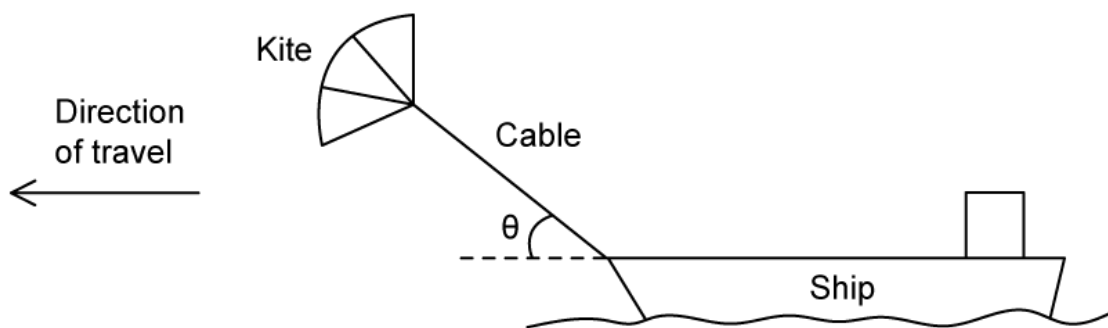

The tension in the cable that connects the kite to the ship is 475 kN. The kite is pulling on the ship at an angle of θ to the horizontal plane of the ship's deck. The ship travels at a steady speed of 14.76 km hr^{-1} when its engines operate with a power output of 5.9 MW. The work done by the engines is 0.365 GJ when turned on for 0.09 hours.

Calculate the efficiency of the kite.

.....

.....

.....

.....

(4 marks)

- (b) The ship continues its journey using both the engine and the kite to maintain the same constant speed. After 0.09 hours with the engine on, the ship drives into a spring net erected between two rocky outcrops. Upon impact, the net force from the ship acts parallel to the direction of extension of twelve identical springs in the net and the ship comes to a complete stop with the springs in the net extended. The ship has a mass of 2200 metric tonnes.

Calculate the extension of one of the springs in the net to the nearest millimetre. Assume no energy is lost upon impact.

.....

.....

(3 marks)

- 3 (a) A golfing team are conducting investigations into the optimum angles at which golfers should hold their clubs to swing for the ball.

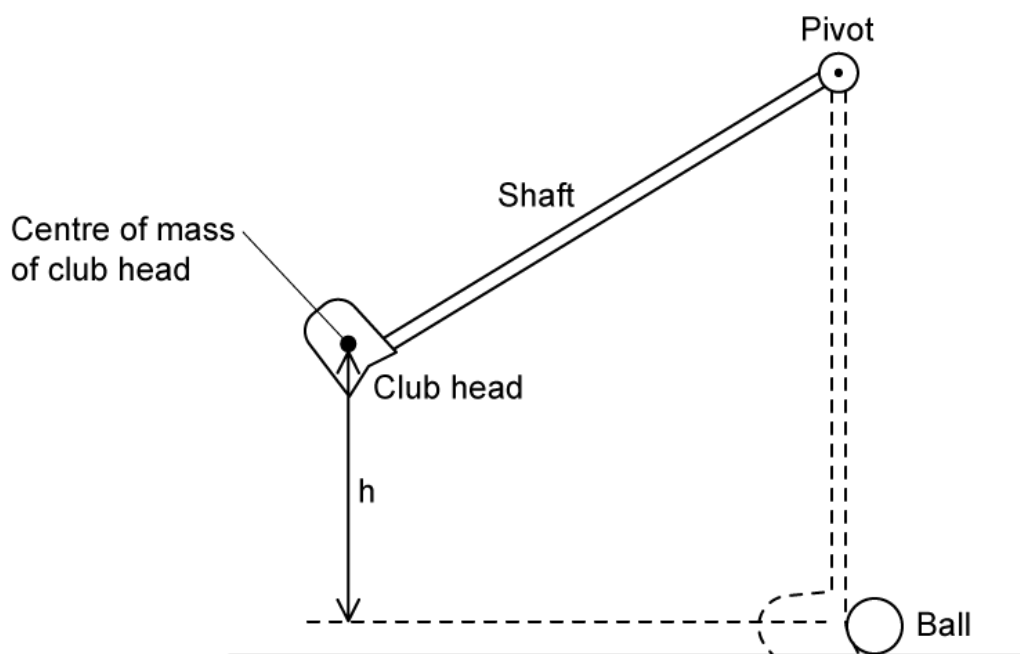

Golf club A is held at an angle of 30° to the vertical at the pivot and golf club B at an angle of 45° . Both golf clubs are 1.05 m long and have the same mass.

Compare the maximum speeds of the club heads just before they hit the ball.

.....

.....

.....

.....

.....

(5 marks)

- (b) Obtain an expression to calculate the time of swing for golf club A if the time of swing for golf club B is 0.23 seconds.

Assume no additional force is applied to the golf clubs apart from their weight during the swing.

(4 marks)

- 4 (a) An object is at rest at the top of a straight slope that makes a fixed angle with the horizontal at a distance h above the ground.

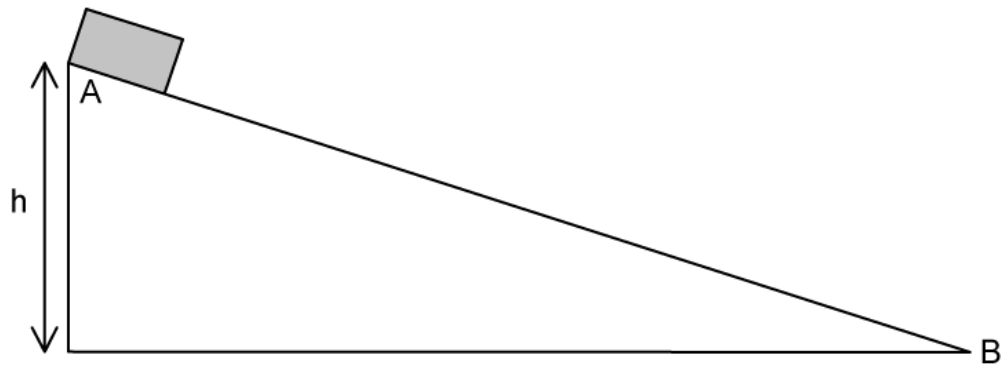

The object is released and slides down the slope from A to B with negligible friction. Assume that the potential energy is zero at B.

Sketch and explain a graph showing:

- (i) The variation of gravitational potential energy of the object along the slope, label P. [2]
- (ii) The variation of kinetic energy of the object along the slope, label K. [3]
- (iii) The variation of kinetic energy of the object along the slope when there is a frictional force between the object and the surface, label F. [3]

.....

.....

.....

.....

.....

.....

.....

.....

(8 marks)

- (b) In a theme park ride, a cage containing passengers falls freely a distance of x m from A to B and travels in a circular arc of radius 25 m. from B to C. The force required for circular motion on a passenger of mass 63.25 kg is 0.064×10^2 kN.

The equation for calculating centripetal force on an object moving in an arc is:

$$F = \frac{mv^2}{r}$$

Brakes are applied at C after which the cage with its passengers travels 70 m along an upward sloping ramp and comes to rest at D. The track, together with relevant distances, is shown in the diagram. CD and makes an angle θ with the horizontal.

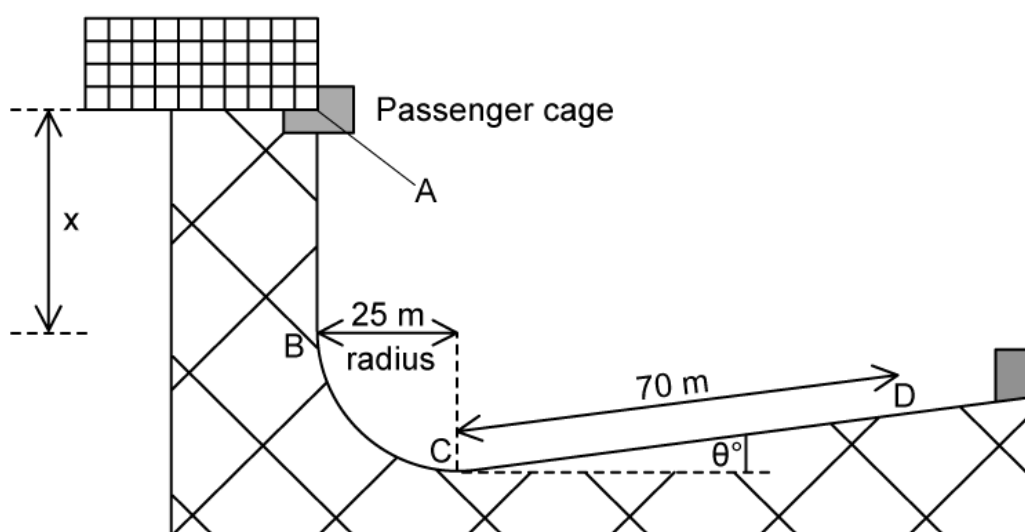

The total mass of the cage and passengers is 3.556×10^2 kg. The average resistive force exerted by the brakes between C and D is 4.4×10^3 N.

Calculate the angle of the ramp to the horizontal, θ .

.....

.....

.....

.....

(5 marks)

- 5 (a) The diagram below shows a projectile launcher with a spring in both a compressed and uncompressed position. When the spring is compressed, in preparation for launching the projectile, the plate is held in place by a pin at three different positions, *P*, *Q* and *R*. When the pin is released the sphere is launched.

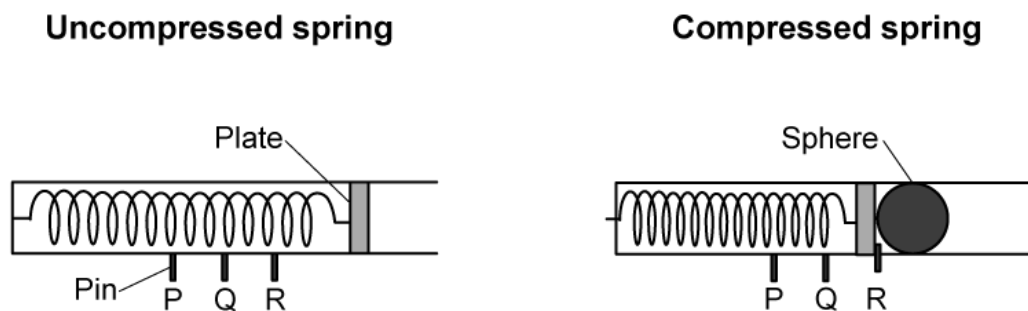

A student hypothesises that the spring constant of the spring inside the launcher has the same value for different compression distances.

The student plans to test the hypothesis by launching the sphere using the launcher.

- (i) State a physics principle or law that can be used in designing and conducting an experiment to test this hypothesis.

[1]

- (ii) Hence, or otherwise, show that $k = \frac{2mgh}{x^2}$

Measurements can be made with equipment usually found in a school laboratory using the principle or law stated in part (i).

[3]

.....

.....

.....

.....

(4 marks)

- (b) Design an experimental procedure to test the hypothesis.

- (i)

In the table below suggest the quantities, their symbols and the equipment used to measure each.

Quantity to be measured	Symbol	Measuring equipment

[3]

(ii) Describe the best procedure that can be used to test the hypothesis.

[5]

.....

.....

.....

.....

.....

.....

.....

.....

.....

.....

(8 marks)

(c) Assess how the experimental data can be analysed to confirm or dispel the hypothesis.

.....

.....

.....

.....

(4 marks)