



DP IB Biology: HL

Your notes

1.1 Cells: Theory

Contents

- * 1.1.1 Cell Theory
- * 1.1.2 Functions of Life
- * 1.1.3 Surface Area to Volume Ratio
- * 1.1.4 Cell Specialisation
- * 1.1.5 Stem Cells
- * 1.1.6 Skills: Cell Theory



Your notes

1.1.1 Cell Theory

Cell Theory

- Until microscopes became powerful enough to view individual cells, no-one knew for certain what living organisms were made from
- A scientist called **Robert Hooke** came up with the term "cells" in the 1660's after examining the structure of cork
- Matthias **Schleiden** and Theodor **Schwann** were two scientists who studied animal and plant cells
 - In 1837, they came up with the idea that **all living organisms are made of cells**
 - This idea is known as '**cell theory**'
 - The cell theory is a **unifying concept** in biology (meaning it is **universally accepted**)
- The cell theory includes **three main ideas**:
 - **All living organisms** are made up of **one or more cells**
 - Cells are the **basic functional unit** (i.e. the basic unit of structure and organisation) in living organisms
 - **New cells** are produced from **pre-existing cells**
- Although cells vary in size and shape they all:
 - Are surrounded by a **membrane**
 - Contain **genetic material**
 - Have **chemical reactions** occurring within the cell that are catalysed by **enzymes**



Your notes

Cell Theory: Atypical Examples

NOS: Looking for trends and discrepancies; although most organisms conform to cell theory, there are exceptions

- Scientists studying cells (e.g. Robert Hooke, Schwann & Schleiden and Pasteur) discovered **trends** when making **observations** of organisms
- The organisms they examined, using microscopes, all appeared to be made of smaller compartments (which we now refer to as cells). They discovered that even the smallest organisms, such as *Amoeba*, were made from at least one cell
- However, advancements in technology (particularly around what can be detailed and seen under a microscope) have enabled scientists to examine many more organisms and **discrepancies** have been discovered which raise questions about whether cell theory applies to all organisms

Atypical examples

- Striated muscle fibres, aseptate fungal hyphae and giant alga are three examples of cells/tissue with structures that question the integrity of the cell theory

Striated muscle fibres

- **Striated muscle fibres** (fused muscle cells) are:
 - **Longer** than typical cells (up to 300 mm in length in comparison to a cardiac muscle cell which has a length of 100 - 150 μm)
 - Have **multiple nuclei** surrounded by a single membrane (sarcolemma)
- These features question the cell theory because striated muscle cells are formed from multiple cells which have fused together (which is how they have many nuclei rather than one) that work together as a single unit, challenging the concept that cells work independently of each other even in a multicellular organism

Aseptate fungal hyphae

- Fungi have many long, narrow branches called **hyphae**
- Hyphae have cell membranes, cell walls and some have septa
- Aseptate fungal hyphae **do not have septa**, thus these cells are **multinucleated** with continuous cytoplasm
- This questions the cell theory because the cells have no end walls making them appear as one cell

Giant Alga (e.g. *Acetabularia*)

- *Acetabularia* can grow to **heights of 100 mm**, and yet consist of **only one cell** with a single nucleus
- *Acetabularia* have a relatively complex structure. They are divided into three parts: rhizoid, stalk and cap
- The features above question the cell theory because the trend for most unicellular organisms is to be small in size and simple in structure



Your notes

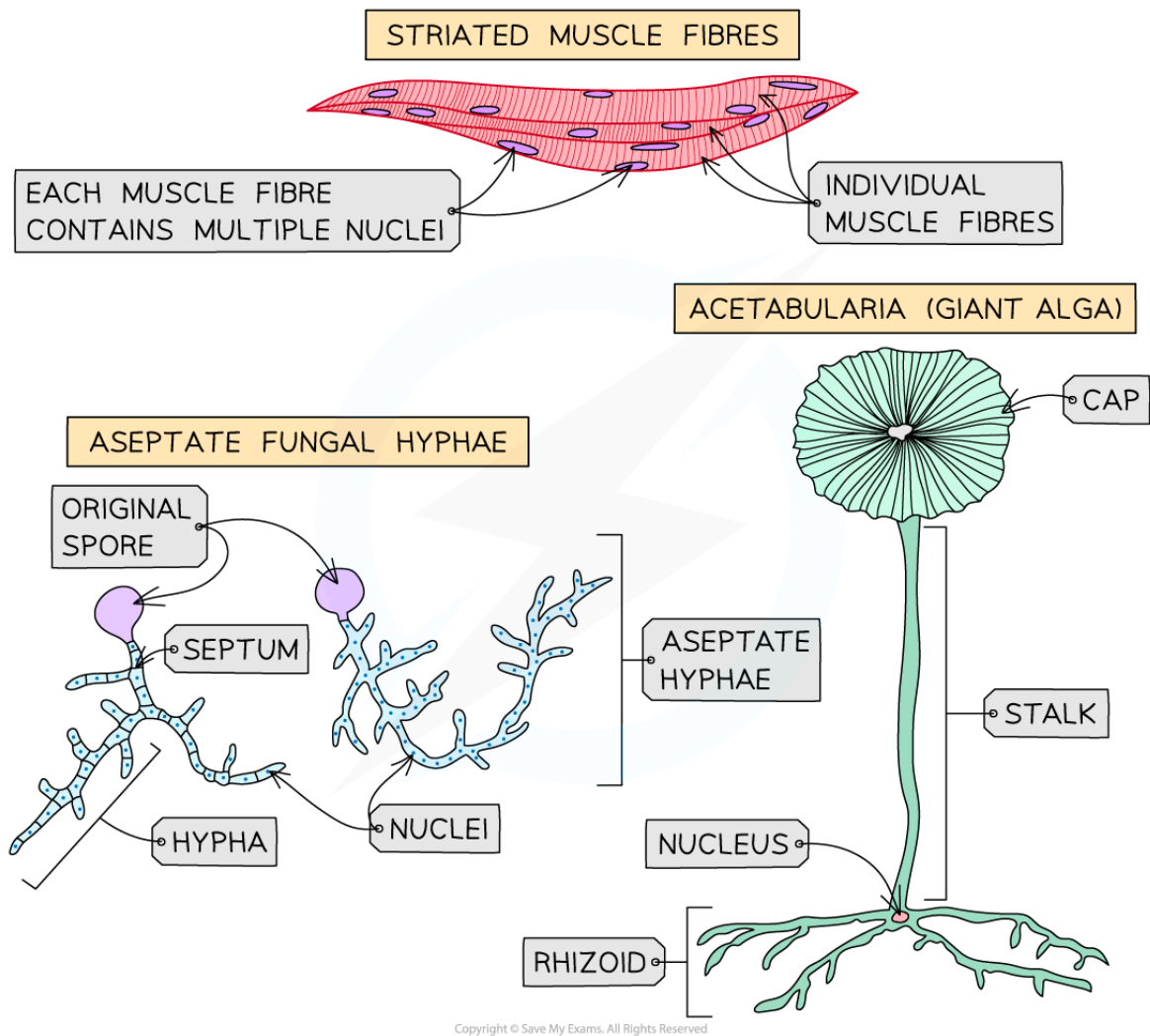

Three atypical examples of the cell theory

Examiner Tip

Don't worry about learning the name of the scientists described above or when the cell theory was first described. You just need to know the three main components of the cell theory and why (by looking at trends and discrepancies) scientists have made exceptions to the theory.

1.1.2 Functions of Life



Your notes

Functions of Life

- Unicellular (single-celled) and multicellular (many cells) organisms must carry out the following functions to stay alive:
 - **Metabolism** - all the enzyme-catalysed reactions occurring in a cell, including cell respiration
 - **Reproduction** - the production of offspring. It may be sexual or asexual
 - **Homeostasis** - the ability to maintain and regulate internal conditions within tolerable limits, including temperature
 - **Growth** - the permanent increase in size
 - **Response** - (or sensitivity), the ability to respond to external or internal changes (stimuli) in their environment. Thus improving their chance of survival
 - **Excretion** - the disposal of metabolic waste products, including carbon dioxide from respiration
 - **Nutrition** - the acquisition of energy and nutrients for growth and development, either by, absorbing organic matter or by synthesising organic molecules (e.g. photosynthesis)



Your notes

Functions of Life: Paramecium & Chlorella

Paramecium

- Paramecium are unicellular protozoans commonly found in freshwater. They range in size from 50 to 320 μm

Chlorella

- Chlorella is a small (2 to 10 μm) unicellular green alga. They are abundant in freshwater and can be found in a symbiotic relationship with Paramecium
- As Chlorella are living they carry out all the functions of life, although due to different structures, there are some differences to Paramecium

Comparison of the Functions of Life Between Paramecium and Chlorella

Function	Paramecium	Chlorella
Metabolism	Metabolic reactions such as respiration and digestion are constantly taking place in the cytoplasm	
Reproduction	Generally asexual. After nuclear division (mitosis) occurs the two nuclei formed are separated by constriction of the cytoplasm	Nuclear division (mitosis) produces autospores that are released when the parent cell wall breaks down
Homeostasis	The contractile vacuoles fill up with water and then expel the water through the plasma membrane to maintain a constant osmotic potential	Extra glucose is stored as starch, in pyrenoids, to maintain the osmotic potential of the cell
Growth	After obtaining nutrition and assimilating the nutrients, the organisms increase in size until it divides	

Copyright © Save My Exams. All Rights Reserved



Your notes

Response	The beating of the cilia moves the <i>Paramecium</i> through the water in response to changes in the environment	Chlorophyll pigments located in the chloroplast absorb light
Excretion	Waste products (e.g. carbon dioxide) are expelled or diffuse out through the plasma membrane	Metabolic waste products (e.g. oxygen) diffuse out of the cell through the plasma membrane
Nutrition	Food particles that are swept into the oral groove are packaged into food vacuoles. After the enzymes, contained within the vacuoles, digest the particles the nutrients are absorbed into the cytoplasm	Synthesises carbohydrates through photosynthesis

Copyright © Save My Exams. All Rights Reserved

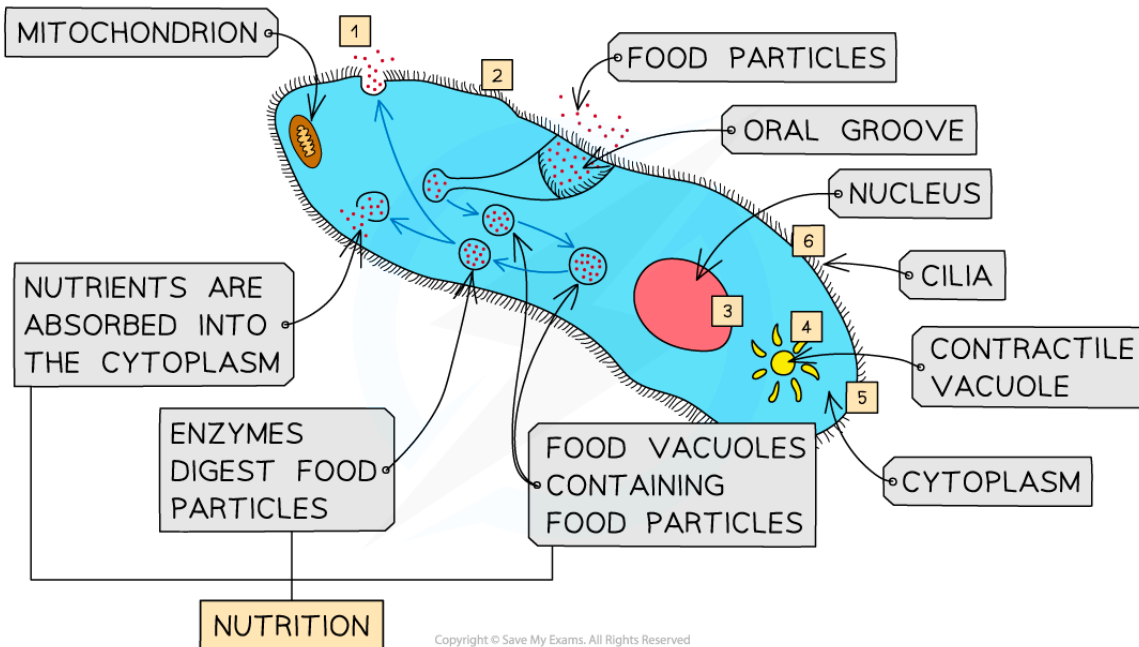

Copyright © Save My Exams. All Rights Reserved



Your notes

1 **EXCRETION:** WASTE PRODUCTS ARE EXPELLED OR DIFFUSE OUT THROUGH THE MEMBRANE

2 **GROWTH:** AFTER OBTAINING NUTRITION AND ASSIMILATING THE NUTRIENTS, THE *Paramecium* INCREASES IN SIZE UNTIL IT DIVIDES

3 **REPRODUCTION:** COMMONLY ASEXUAL. NUCLEAR DIVISION OCCURS, THE TWO NUCLEI ARE THEN SEPARATED BY THE CONSTRICTION OF THE CYTOPLASM

4 **HOMEOSTASIS:** FILL UP WITH WATER THEN EXPEL IT THROUGH THE MEMBRANE TO MAINTAIN A CONSTANT OSMOTIC POTENTIAL

5 **METABOLISM:** METABOLIC REACTIONS SUCH AS RESPIRATION AND DIGESTION CONSTANTLY TAKING PLACE IN THE CYTOPLASM

6 **RESPONSE:** BEATING OF THE CILIA MOVES THE *Paramecium* THROUGH WATER IN RESPONSE TO CHANGES

Copyright © Save My Exams. All Rights Reserved

The functions of life in Paramecium



Your notes

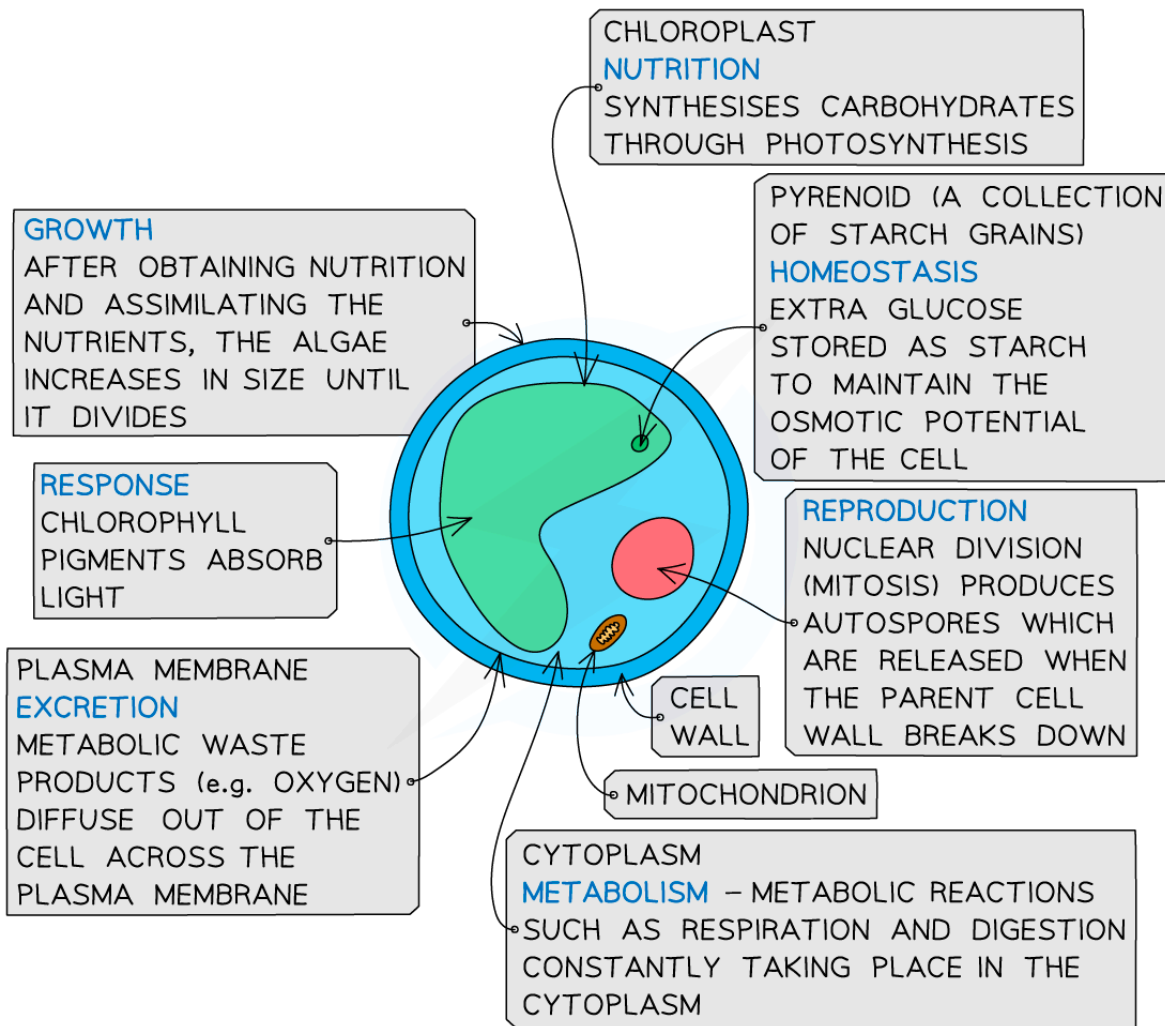

Copyright © Save My Exams. All Rights Reserved

The functions of life in Chlorella

 **Examiner Tip**

To remember the functions of life think of **MR H GREN**. Note the similarities in the functions of life between *Paramecium* and *Chlorella*.



Your notes

1.1.3 Surface Area to Volume Ratio

Surface Area to Volume Ratio

- For cells to survive, metabolic reactions must be occurring, these reactions depend on:
 - Materials** constantly being **exchanged** across the **plasma membrane**
 - The **volume** or **mass** of cytoplasm (as this is where the reactions take place)
- As organisms **increase in size** their **SA:V ratio decreases**
 - There is **less surface area** for the absorption of nutrients and gases and secretion of waste products
 - The **greater volume** results in a **longer diffusion distance** to the cells and tissues of the organism
- Thus the **rate** at which substances (e.g. oxygen and heat) are **exchanged** across the plasma membrane is dependent on the **surface area** (the **larger** the surface area the **more** substances are exchanged)
- The rate at which a cell **metabolises** is dependent on the **mass** or **volume** of the cytoplasm (the **larger** the mass or volume the **longer** it takes for metabolic reactions to occur)

Limitations to cell size

- Single-celled organisms have a high SA:V ratio which allows for the exchange of substances to occur via simple diffusion
 - The large surface area allows for maximum absorption of **nutrients** and **gases** and secretion of **waste products**
 - The small volume means the diffusion distance to all organelles is **short**
- A consequence of the SA:V ratio is that cells cannot grow bigger indefinitely. Once the ratio becomes too small, growth must stop and the cells must divide
- To overcome this, large multicellular animals and plants have **evolved adaptations** to facilitate the exchange of substances between their environment
- They have a large variety of specialised cells, tissues, organs and systems
 - Eg. gas exchange system, circulatory system, lymphatic system, urinary system, xylem and phloem



Your notes

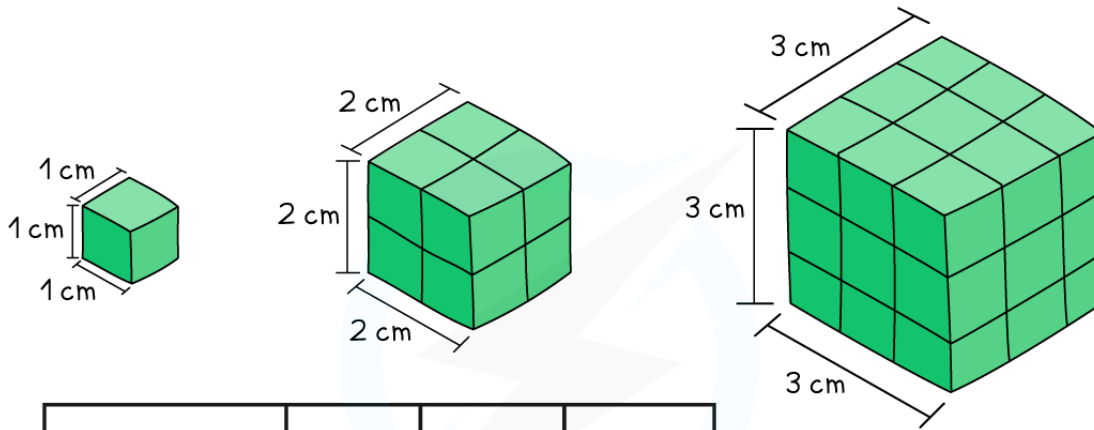

Surface area	6 cm ²	24 cm ²	54 cm ²
Volume	1 cm ³	8 cm ³	27 cm ³
Surface area: volume	6:1	3:1	2:1

Copyright © Save My Exams. All Rights Reserved

As the size of an organism increases, its surface area : volume ratio decreases. Notice for this particular shape the distance between the surface and the centre increases with size.

 **Examiner Tip**

Remember the rate of metabolism is dependent on the mass or volume of the cell whereas the rate of exchange is dependent on the surface area.



Your notes

1.1.4 Cell Specialisation

Emergent Properties

- Multicellular organisms are able to undertake functions that unicellular organisms cannot, e.g. move over vast distances and digest large macromolecules
- This is a result of properties emerging when **individual cells organise and interact** to produce living organisms
 - Scientists sometimes summarise this with the phrase "*The whole is greater than the sum of its parts*"
- Traditionally, scientists have approached the study of biology from a reductionist perspective, looking at the individual cells, however, due to emergent properties there is an argument that the **systems approach** should be used

The organisation of multicellular organisms

- In multicellular organisms, **specialised cells** of the **same type** group **together** to form **tissues**
- A tissue is a group of cells that **work together** to perform a **particular function**. For example:
 - Epithelial cells group together to form epithelial tissue (the function of which, in the small intestine, is to absorb food)
 - Muscle cells (another type of specialised cell) group together to form muscle tissue (the function of which is to contract in order to move parts of the body)
- Different tissues **work together** to form **organs**. For example:
 - The heart is made up of many different tissues (including cardiac muscle tissue, blood vessel tissues and connective tissue, as well as many others)
- Different organs **work together** to form **organ systems**
- Organ systems **work together** to carry out the life functions of a complete **organism**



Your notes

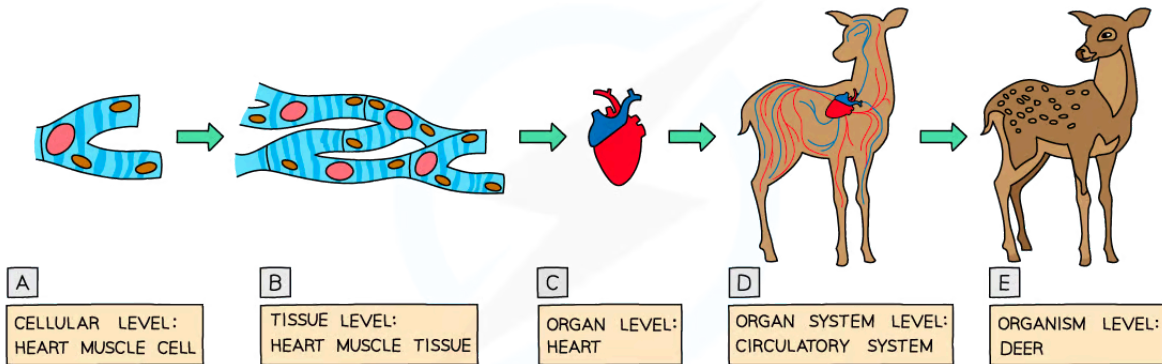

Copyright © Save My Exams. All Rights Reserved



The organisation of multicellular organisms

Levels of Organisation in Humans Table

Specialised cell	Tissue	Organ	Organ system
Epithelial cell	Epithelial tissue (made up of epithelial cells)	Stomach (made up of epithelial tissue, muscular tissue and glandular tissue)	Digestive system (made up of all the organs involved in the digestion and absorption of food, including the stomach, small intestine, large intestine and liver, as well as many others)
Muscle cell	Muscle tissue (made up of muscle cells)	Bladder (made up of muscle tissue, epithelial tissue, connective tissue and fatty tissue)	Urinary system (made up of the kidneys, ureters, bladder and urethra)
Neurones (nerve cells)	Nervous (neural) tissue (made up of neurones)	Brain (made up of gray matter tissue, white matter tissue and the tissues that make up the blood vessels in the brain)	Central nervous system (made up of the brain and the spinal cord)
Rod cells and cone cells	Retina (made up of rods and cones)	Eye (made up of many tissues, including the retina, cornea, sclera and choroid)	Visual system (made up of the eyes, optic nerves and the visual cortex in the brain)

Copyright © Save My Exams. All Rights Reserved



Your notes

Cell Differentiation

- In complex **multicellular** organisms eukaryotic cells become **specialised** for **specific functions**. This can also be referred to as **the division of labour**
- Specialisation enables the cells in a tissue to function more efficiently as they develop specific adaptations for that role. The development of these distinct specialised cells occurs by differentiation
- These specialised eukaryotic cells have **specific adaptations** to help them carry out their functions
- For example, the **structure of a cell** is adapted to help it carry out its function (this is why specialised eukaryotic cells can look extremely **different** from each other)
- Structural adaptations include:
 - The **shape** of the cell
 - The organelles the cell contains (or doesn't contain)
- For example:
 - Cells that make large amounts of **proteins** will be adapted for this function by containing **many ribosomes** (the organelle responsible for protein production)

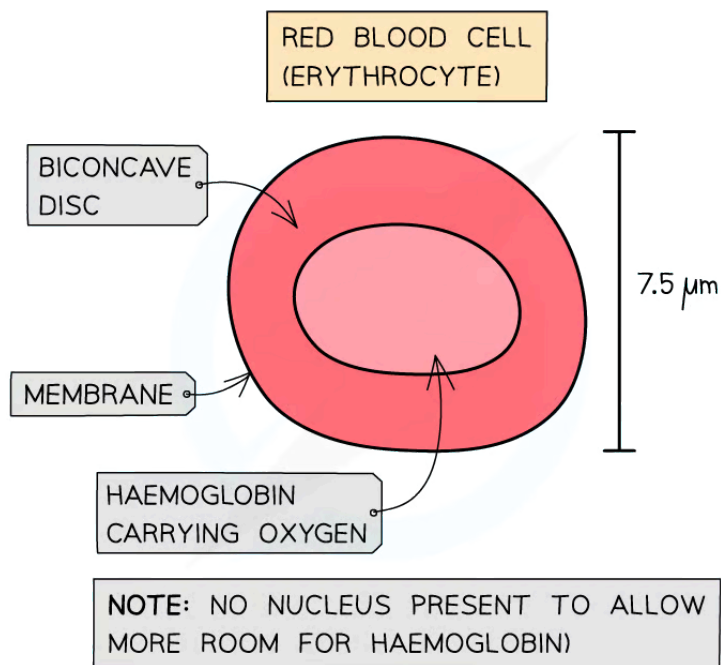

Copyright © Save My Exams. All Rights Reserved

The biconcave shape of erythrocytes increases the surface area available for oxygen absorption



Your notes

Gene Expression

- Every nucleus within the cells of a multicellular organism contains the same genes, that is, all cells of an organism have the identical genome
- Despite cells having the same genome, they have a diverse range of functions because during **differentiation** certain genes are **expressed** ('switched' on)
- Controlling gene expression is the key to development as the cells differentiate due to the different genes being expressed
- Once certain genes are expressed the specialisation of the cell is usually fixed so the cell cannot adapt to a new function

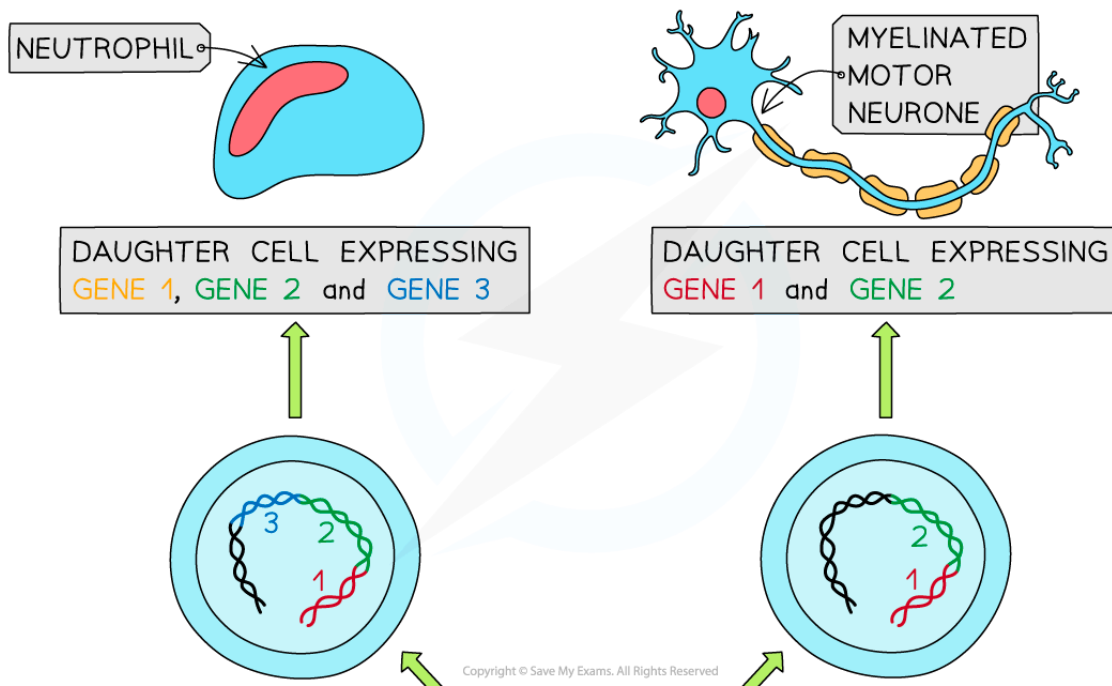



Your notes

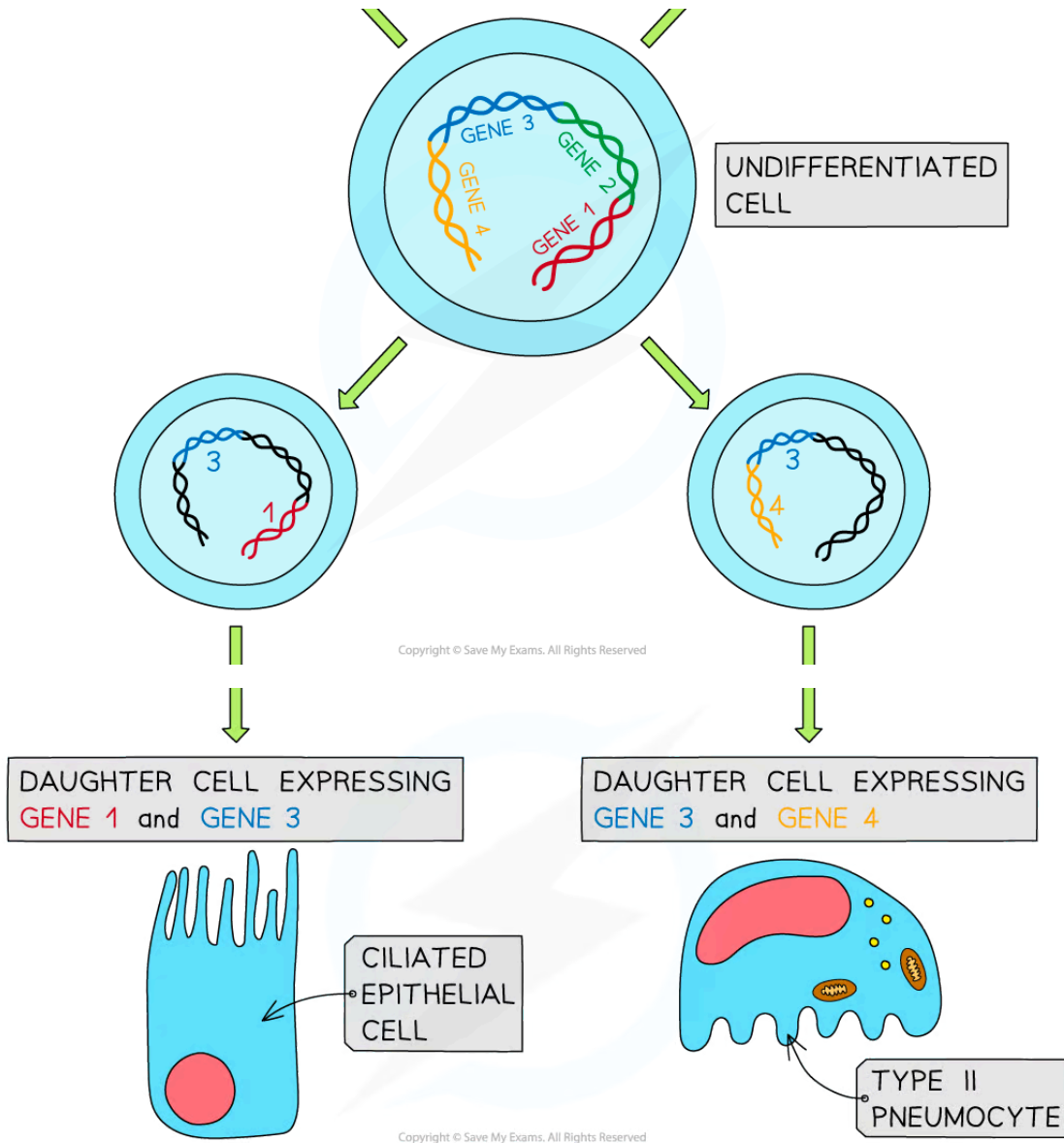

Expression of genes resulting in cell differentiation

💡 Examiner Tip

It's important to start learning some biological examples of each of these levels of organisation. Try and start with an organ system, such as the circulatory system or nervous system, and work your way down the levels of organisation noting down examples of organs, tissues and specialised cells as you go! Alternatively, start with a specialised cell you know of, such as a red blood cell, and work your way up the levels of organisation until you reach an organ system.



Your notes

1.1.5 Stem Cells

Stem Cells

- A **stem cell** is a cell that can **divide** (by mitosis) an **unlimited number of times**
- Each new cell (produced when a stem cell divides) has the potential to **remain a stem cell** or to develop into a **specialised cell** such as a blood cell or a muscle cell (by a process known as **differentiation**)
- This ability of stem cells to differentiate into more specialised cell types is known as **potency**
- There are four types of potency:
 - **Totipotency** – totipotent stem cells are stem cells that can differentiate into **any cell type found in an embryo, as well as extra-embryonic cells** (the cells that make up the placenta). The zygote formed when a sperm cell fertilises an egg cell is totipotent, as are the embryonic cells up to the 16-cell stage of human embryo development
 - **Pluripotency** – pluripotent stem cells are embryonic stem cells that can differentiate into **any cell type found in an embryo** but are **not able to differentiate into extra-embryonic cells** (the cells that make up the placenta)
 - **Multipotency** – multipotent stem cells are adult stem cells that can differentiate into closely related cell types (e.g. bone marrow stem cells differentiate into different blood cells)
 - **Unipotency** – unipotent stem cells are adult cells that can only differentiate into their **own lineage**, e.g. heart muscle cells (cardiomyocytes) can generate new cardiomyocytes through the cell cycle to build and replace heart muscle. Most cells in animal bodies are unipotent

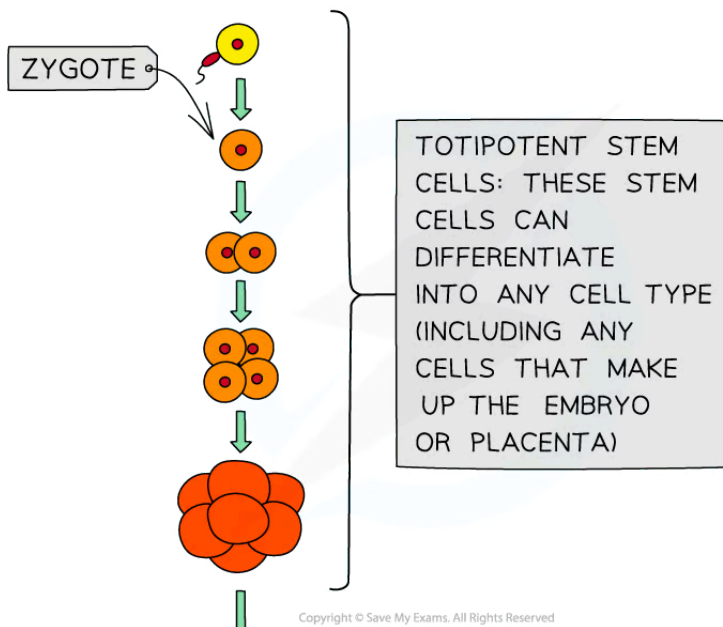



Your notes

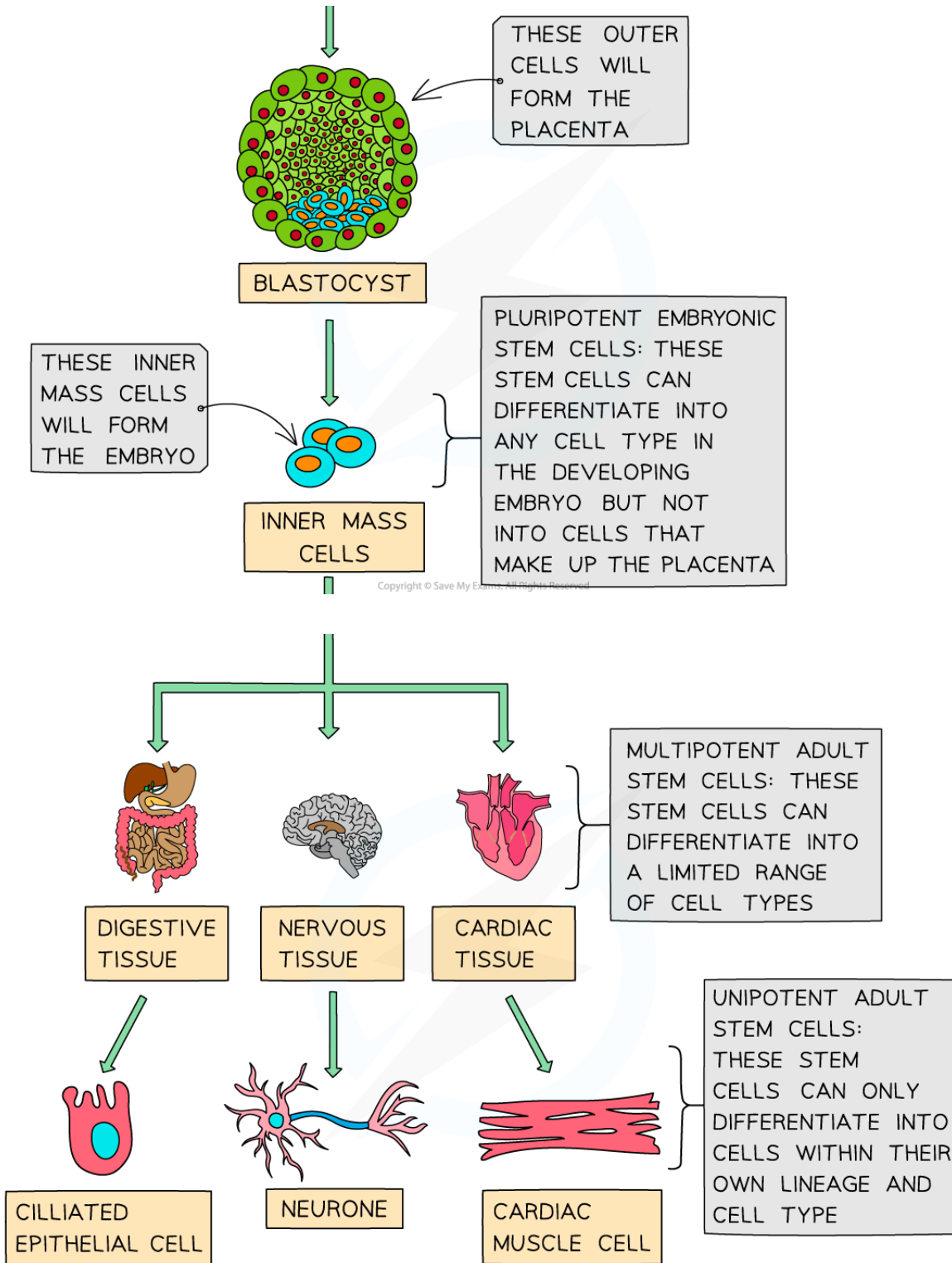

There are different levels of potency that cells can have. Totipotent cells have the highest potency and can therefore differentiate into any type of cell. Unipotent cells have the lowest potency, only being able to divide into one cell type.



Your notes

Examiner Tip

Remember the **two** key properties of stem cells are that they can **self-renew** (capacity to divide) and can **differentiate**. Make sure you learn the three levels of potency of stem cells described above, and what range of cell types these stem cells can differentiate into. Don't forget, while still classed as stem cells (as they can divide any number of times), only a limited range of specialised cells can be formed from adult stem cells as they have already partially differentiated. For example, stem cells in bone marrow can only produce cells that differentiate into the different types of blood cells.



Your notes

Stem Cells: Therapeutic Use

- Currently, there are very few therapeutic uses of stem cells, although scientists around the world are actively involved in researching potential therapies
- The research is being carried out on **embryonic** (totipotent and pluripotent) and **adult** (multipotent) stem cells

Use of embryonic stem cells

- Due to their ability to differentiate into multiple cell types, stem cells have huge potential in the therapeutic treatment of disease
- For many countries, such as the USA and some countries within the EU, the use of embryonic stem cells is banned, even for research
- In other countries, such as the UK, the use of embryonic stem cells is allowed for research but is very **tightly regulated**
- Embryonic stem cells can be one of two potencies:
 - **Totipotent** if taken in the first 3–4 days after fertilisation
 - **Pluripotent** if taken on day 5
- The embryos used for research are often the **waste (fertilised) embryos** from *in vitro* **fertilisation treatment**
 - This means these embryos have the **potential to develop into human beings**
 - This is why many people have **ethical objections** to using them in research or medicine

Stargardt's disease

- Stargardt's disease is the most common inherited form of **juvenile macular degeneration** and mainly affects children and adolescents
- The macula is located in the central region of the retina and damage to this area limits our central vision and colour perception
- The disease is commonly caused by a **mutation of the ABCA4 gene** resulting in a protein in the retina malfunctioning, eventually leaving the person legally blind
- One treatment that was researched was the **injection of retina cells derived** from embryonic stem cells into patients eyes. This treatment had success and no harmful side effects were experienced, however trials are still ongoing

Use of multipotent adult stem cells

- As tissues, organs and organ systems develop, cells become more and more **specialised**
- Having differentiated and specialised to fulfil particular roles, most adult cells gradually lose the ability to divide until, eventually, they are no longer able to divide
- However, small numbers of stem cells (known as **adult stem cells**) remain to produce new cells for the essential processes of **growth, cell replacement and tissue repair**



Your notes

- Although these adult stem cells can divide (by mitosis) an unlimited number of times, they are only able to produce a **limited range of cell types** – they are **multipotent**
 - For example, the stem cells found in bone marrow (hematopoietic stem cells) are multipotent adult stem cells – they can only differentiate into blood cells (red blood cells, monocytes, neutrophils and lymphocytes)
 - In adults, multipotent stem cells can be found **throughout the body** (eg. in the bone marrow, skin, gut, heart and brain)
- Research is being carried out on **stem cell therapy**, which is the introduction of adult stem cells into damaged tissue to treat diseases (eg. leukemia) and injuries (eg. skin burns)

Leukaemia

- Leukaemia is the generalised term referring to a group of **cancers** that develop in the **bone marrow**
- It is caused by mutations in genes resulting in the **over-production** of **abnormal white blood cells** (leukocytes)
- To destroy these mutated cells in the bone marrow patients undergo **chemotherapy**
- However, as the chemicals injected into the patient's body during chemotherapy destroy all bone marrow cells, **hematopoietic stem cells (HSCs)**, the adult stem cells found in bone marrow, are removed using a large needle before treatment
- These HSCs are stored frozen and after chemotherapy, they are returned via a transfusion. Once in the body, the HSCs re-establish themselves in the bone marrow where they begin producing blood cells

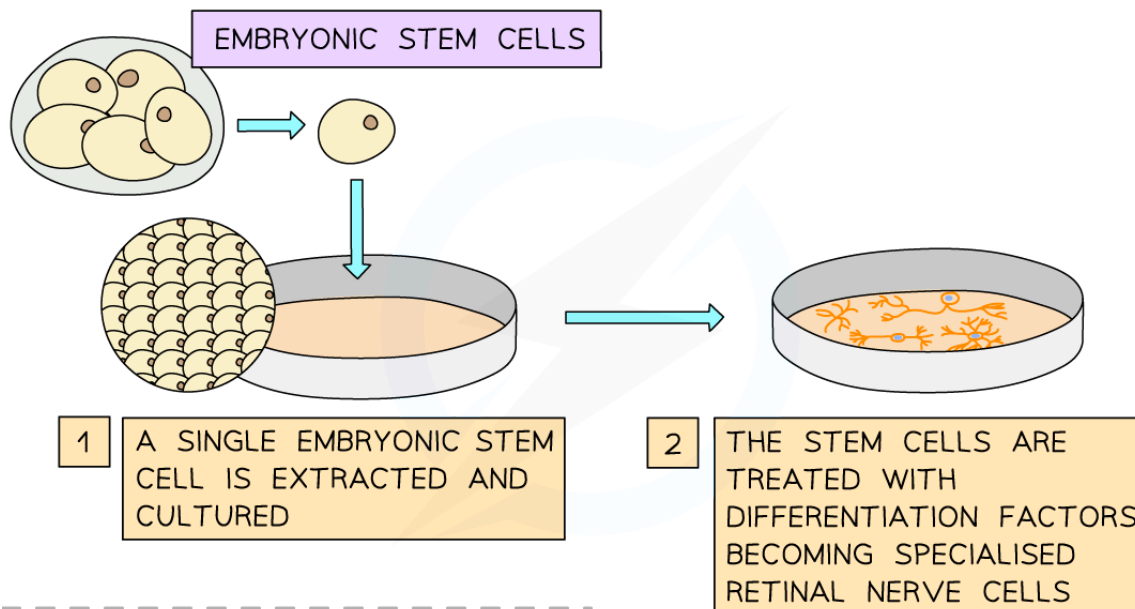

Copyright © Save My Exams. All Rights Reserved



Your notes

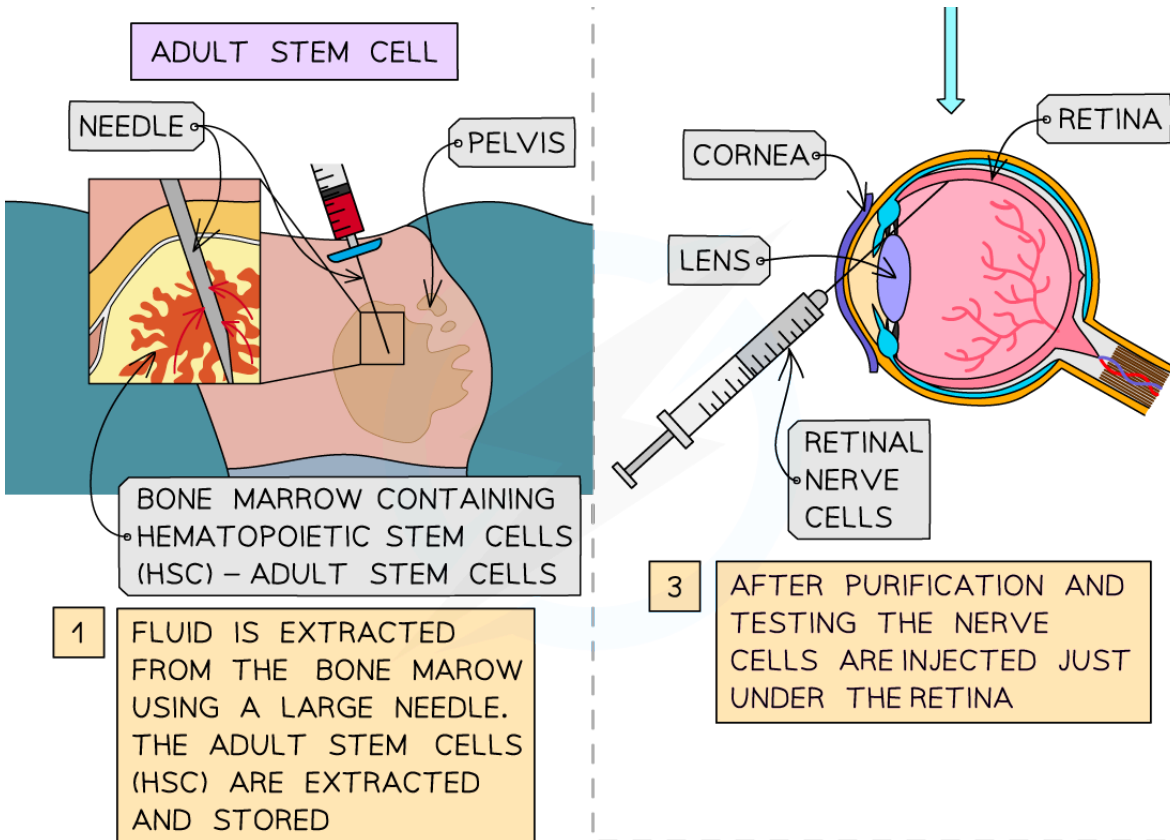

Copyright © Save My Exams. All Rights Reserved



Your notes

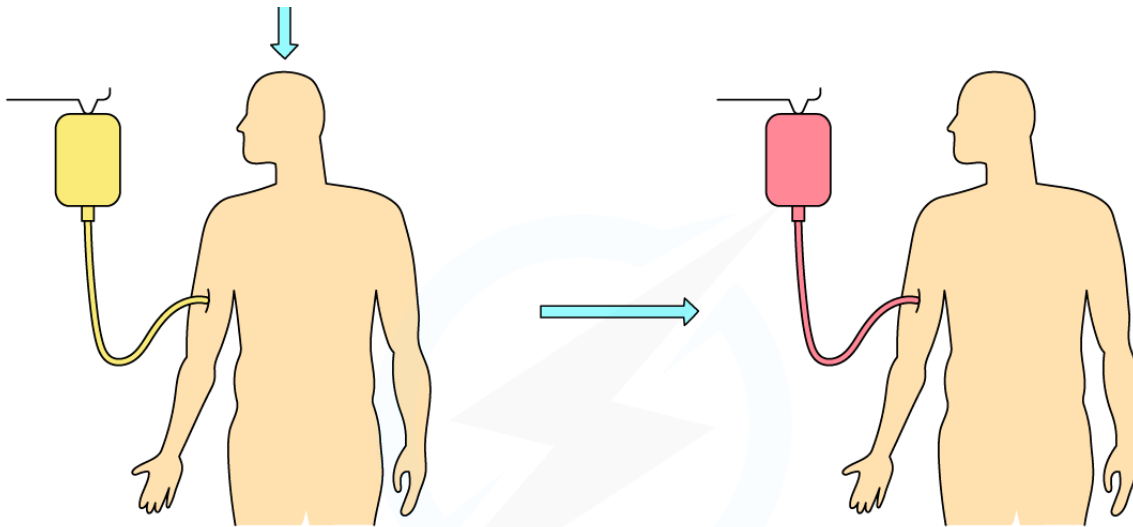

2 THE PATIENT UNDERGOES CHEMOTHERAPY. THIS DESTROYS THE CANCER CELLS IN THE BONE MARROW

3 THE HSC (ADULT STEM CELLS) ARE RETURNED TO THE PATIENTS BODY WHERE THEY TRAVEL TO THE BONE MARROW AND BEGIN PRODUCING NEW BLOOD CELLS

Copyright © Save My Exams. All Rights Reserved

Therapeutic uses of embryonic and adult stem cells



Your notes

Stem Cells: Ethics

NOS: Ethical implications of research; research involving stem cells is growing in importance and raises ethical issues

- **Ethics** are the rules provided by external sources that allow us to determine whether something is right or wrong
- Before scientists undertake research it is important for them to consider the ethics and consequences
- Research involving stem cells may:
 - Lead scientists to make discoveries and create beneficial technologies that would not have occurred if the research had been banned
 - Cure diseases or disabilities
 - Enable organs to be regenerated or repaired, thus reducing the demand for organ transplants

Sources of Stem Cells

- One of the ethical considerations researchers need to take is to determine what the source of the stem cells is to be. There are **three** possible sources:
 - Embryos, which can be created using therapeutic cloning
 - Cord blood (umbilical) of new-born babies, which can be frozen and stored
 - Specific adult tissues, e.g. bone marrow

Ethics of Using Stem Cells

Arguments for:

- Embryonic stem cells:
 - These cells are totipotent or pluripotent therefore they can differentiate into any cell type and thus give the patient a **higher chance of living a healthy life**
 - Embryonic stem cells are not differentiated. Therefore there is **less chance of genetic damage**, due to an accumulation of mutations, which **improves** the likelihood of a **healthy life** for the patient
 - Any of these cells produced by **IVF** that have been set aside to be **discarded** could instead be used for research into incurable diseases
- Cord blood stem cells:
 - Can be **easily obtained and stored** and therefore are readily available when required
 - Are fully compatible with the tissues of the adult, as they are genetically identical, and therefore **reduce the risk of rejection** if used
 - Would be lost when the umbilical cord is discarded
- Adult stem cells:
 - It is less controversial to use adult stem cells compared to embryonic stem cells because the **donor is able to give permission**, e.g., many people **donate bone marrow** to help treat **leukaemia patients**
 - There is a **lower chance of rejection** as the patient's **own** adult stem cells are being used to treat them

- A lower chance of developing into tumours
- Can be removed without any long-lasting side effects to the patient



Your notes

Arguments against:

- Embryonic stem cells:
 - These cells have a higher risk of developing into tumours
 - The process involves the creation and destruction of embryos (but at which point are embryos considered alive)
- Cord blood stem cells:
 - The cells are multipotent and therefore have a limited capacity to differentiate into different cell types
- Adult stem cells:
 - Adult stem cells are difficult to obtain as there are a small number of them and so they can be painful to extract as they are buried deep in tissue
 - Are multipotent and therefore have a limited capacity to differentiate into different cell types
 - If adult stem cells are being donated from one person to another they need to be a **close match** in terms of blood type and other body antigens or there is a chance that the cells used will be **rejected** by the patient's **immune system**

Stem Cell Ethics Table



Your notes

Source of Stem Cells	For	Against
Embryonic	<ul style="list-style-type: none"> ◦ Are totipotent or pluripotent therefore they can differentiate into any cell type and thus give the patient a higher chance of living a healthy life ◦ Are not differentiated. Therefore, there is less chance of genetic damage, due to an accumulation of mutations, which improves the likelihood of a healthy life for the patient ◦ Those produced by IVF, that might be discarded, could be used in research on incurable diseases 	<ul style="list-style-type: none"> ◦ Have a higher risk of developing into tumours ◦ Involves the creation and destruction of embryos (but at which point are embryos considered alive)
Cord	<ul style="list-style-type: none"> ◦ Can be easily obtained and stored and therefore are readily available when required ◦ Are fully compatible with the tissues of the adult, as they are genetically identical, and therefore reduce the risk of rejection if used ◦ Would be lost when the umbilical cord is discarded so if they are harvested, they are available if required 	<ul style="list-style-type: none"> ◦ Are multipotent and therefore have a limited capacity to differentiate into different cell types



Your notes

<p>Adult</p>	<ul style="list-style-type: none"> ◦ Use is less controversial than embryonic stem cells because the donor can give permission, e.g. many people donate bone marrow to help treat leukaemia patients ◦ Have a lower chance of rejection as the patient's own adult stem cells are being used to treat them ◦ Have a lower chance of developing into tumours ◦ Can be removed without destroying the adult that the cells were extracted from 	<ul style="list-style-type: none"> ◦ Are difficult to obtain as there are few of them and they are painful to extract as they are buried deep in tissue ◦ Are multipotent and therefore have a limited capacity to differentiate into different cell types ◦ If adult stem cells are being donated from one person to another, they need to be a close match in terms of blood type and other body antigens or there is a chance that the cells used will be rejected by the patient's immune system
---------------------	---	--

Copyright © Save My Exams. All Rights Reserved

 **Examiner Tip**

It is important to learn arguments for and against using the three sources of stem cells for therapeutic uses.



Your notes

1.1.6 Skills: Cell Theory

Practical 1: Using a Microscope

- Many biological structures are too small to be seen by the naked eye
- Optical (light) microscopes are an invaluable tool for scientists as they allow for tissues, cells and organelles to be seen and studied
- For example, the movement of chromosomes during mitosis can be observed using a microscope

How optical (light) microscopes work

- Light is directed through the thin layer of biological material that is supported on a glass slide
- This light is focused through several lenses so that an image is visible through the eyepiece
- The magnifying power of the microscope can be increased by rotating the higher power objective lens into place

Apparatus

- The key components of an optical (light) microscope are:
 - The eyepiece lens
 - The objective lenses
 - The stage
 - The light source
 - The coarse and fine focus
- Other tools used:
 - Forceps
 - Scissors
 - Scalpel
 - Coverslip
 - Slides
 - Pipette



Your notes

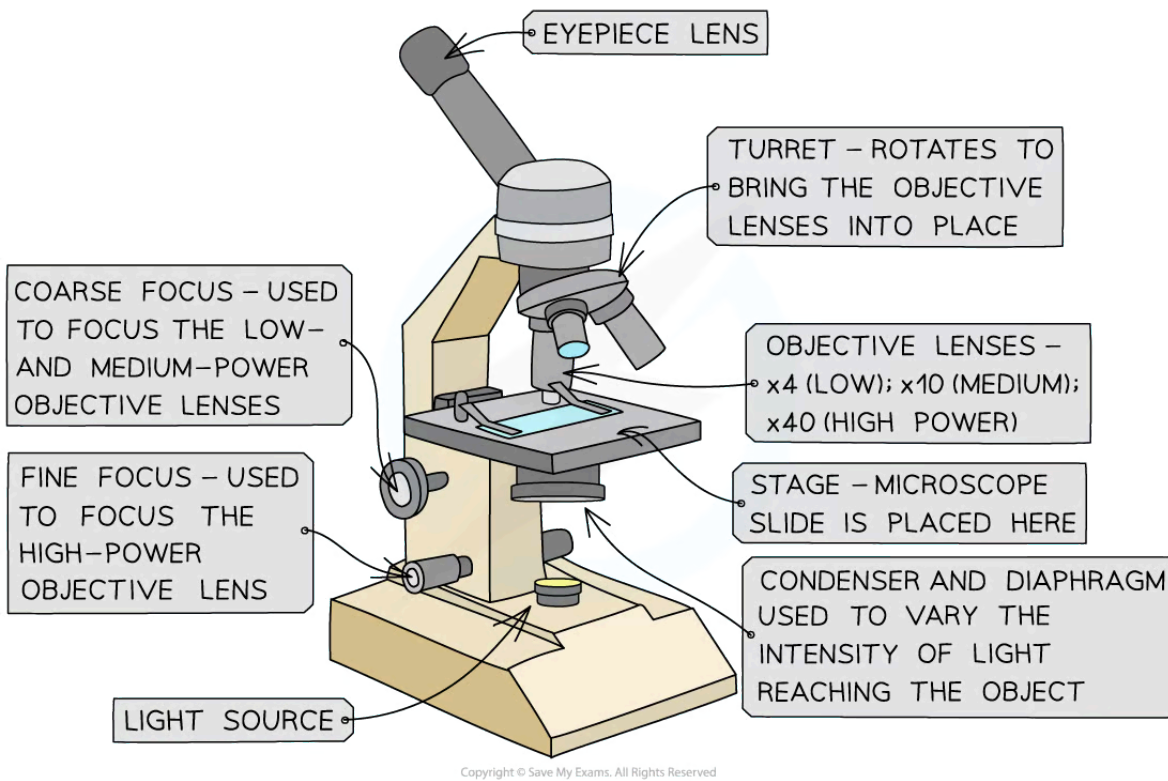

Image showing all the components of an optical (light) microscope

Method

- Preparing a slide using a **liquid specimen**:
 - Add a few drops of the sample to the slide using a pipette
 - Cover the liquid/smear with a coverslip and gently press down to **remove air bubbles**
 - **Wear gloves** to ensure there is no cross-contamination of foreign cells

- Preparing a slide using a **solid specimen**:
 - Use scissors to cut a small sample of the tissue
 - Peel away or cut a **very thin layer** of cells from the tissue sample to be placed on the slide (using a scalpel or forceps)
 - Some tissue samples need be treated with chemicals to kill/make the tissue rigid
 - A **stain** may be required to make the structures visible depending on the type of tissue being examined
 - Gently place a coverslip on top and press down to remove any air bubbles
 - Take care when using sharp objects and wear gloves to prevent the stain from dying your skin

- Place the microscope slide on the **stage**, fix in place using the stage clips (ensure the microscope is plugged in and on)

- When using an optical microscope always **start with the low power objective lens**:
 - It is **easier to find** what you are looking for in the field of view
 - This helps to **prevent damage** to the lens or coverslip in case the stage has been raised too high
- Whilst looking through the **eyepiece lens** move the **coarse focusing knob** until the specimen comes into **focus**. The **fine focusing knob** should be used to sharpen the focus on particular parts (and at higher objective lens only)
- To examine the whole slide move it carefully with your hands (or if using a binocular microscope use the stage adjusting knobs)
- **Once** you have **focused** on the object/structure then carefully **move to higher objective lens** (10X and 40X). If resistance is felt do not continue to move the turret. At the **higher objective** powers **only** use the **fine focusing knob**
 - **Do not move** the **stage down** when moving to higher objective lens
- Unclear or blurry images:
 - Switch to the lower power objective lens and try using the **coarse focus** to get a clearer image
 - Consider whether the specimen sample is **thin enough** for light to pass through to see the structures clearly
 - There could be **cross-contamination** with foreign cells or bodies
- Use a **calibrated** graticule to take measurements of cells
 - A **graticule** is a small disc that has an engraved **scale**. It can be placed into the eyepiece of a microscope to act as a ruler in the field of view
 - As a graticule has no fixed units it must be **calibrated** for the objective lens that is in use. This is done by using a scale engraved on a microscope slide (**a stage micrometer**)
 - By using the two scales together the number of micrometers each graticule unit is worth can be worked out
 - After this is known the graticule can be used as a **ruler** in the field of view



Your notes



Your notes

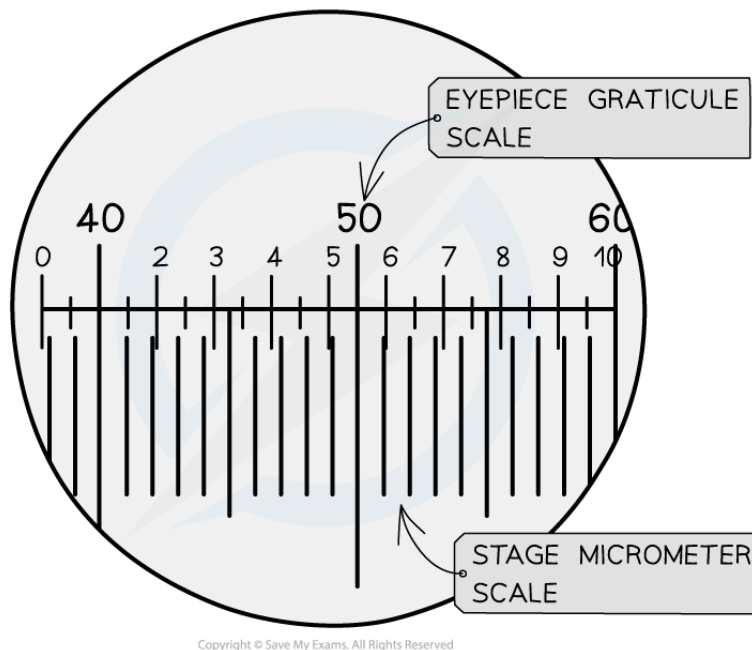

The stage micrometer scale is used to find out how many micrometers each graticule unit represents

Drawing cells

- To record the observations seen under the microscope (or from photomicrographs taken) a labelled biological drawing is often made
- **Biological drawings** are line pictures which show specific features that have been observed when the specimen was viewed
- There are a number of rules/conventions that are followed when making a biological drawing

Guidelines for microscope drawings

- The conventions are:
 - The drawing must have a title
 - The **magnification** under which the observations shown by the drawing are made must be recorded
 - A **sharp HB pencil** should be used (and a good eraser!)
 - Drawings should be on plain white paper
 - Lines should be **clear, single lines** (no thick shading)
 - **No shading**
 - The drawing should take up as much of the space on the page as possible
 - Well-defined structures should be drawn
 - The drawing should be made with **proper proportions**
 - **Label lines** should not cross or have arrowheads and should **connect directly** to the part of the drawing being labelled



Your notes

- Label lines should be kept to one side of the drawing (in parallel to the top of the page) and drawn with a **ruler**
- Drawings of cells are typically made when visualising cells at a higher magnification power, whereas plan drawings are typically made of tissues viewed under lower magnifications (individual cells are never drawn in a plan diagram)

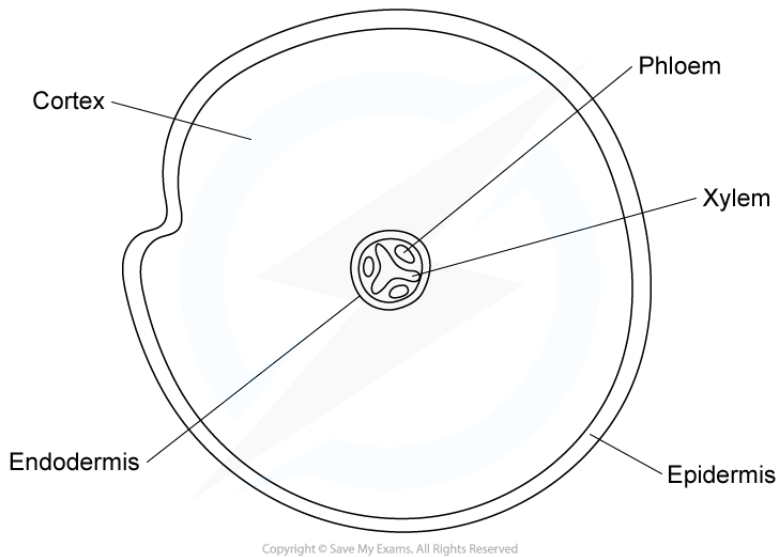

An example of a tissue plan drawn from a low-power image of a transverse section of a root. There is no cell detail present.

Magnification calculations

- Magnification** is **how many times bigger** the image of a specimen observed is in comparison to the actual (real-life) size of the specimen
- The **magnification** (M) of an object can be calculated if both the size of the image (I), and the actual size of the specimen (A), is known



Your notes

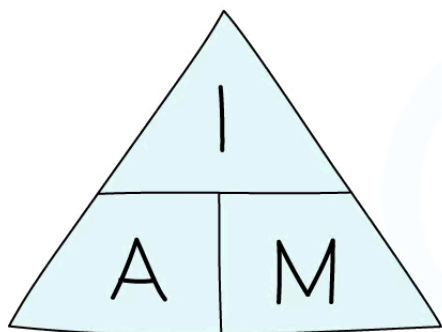

WHERE: I = IMAGE/DRAWING SIZE
A = ACTUAL SIZE OF IMAGE
M = MAGNIFICATION

Copyright © Save My Exams. All Rights Reserved



An equation triangle for calculating magnification

Worked example

An **image** of an animal cell is 30 mm in size and it has been **magnified** by a factor of X 3000. What is the **actual** size of the cell?

To find the **actual** size of the cell:

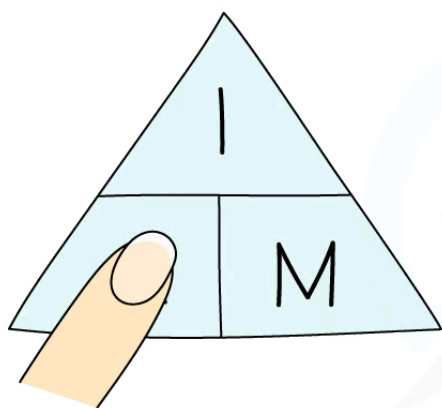

$$A = \frac{I}{M} = \frac{30 \text{ mm}}{3000} = 0.01 \text{ mm}$$

$$0.01 \text{ mm} = 10 \mu\text{m}$$

Copyright © Save My Exams. All Rights Reserved



Using the appropriate units



Your notes

- The size of cells is typically measured using the **micrometre** (μm) scale, with cellular structures measured in either **micrometers** (μm) or **nanometers** (nm)
- When doing calculations all measurements must be in the **same units**. It is best to use the **smallest unit** of measurement shown in the question
- To convert units, multiply or divide depending if the units are **increasing or decreasing**
- Magnification does **not** have units

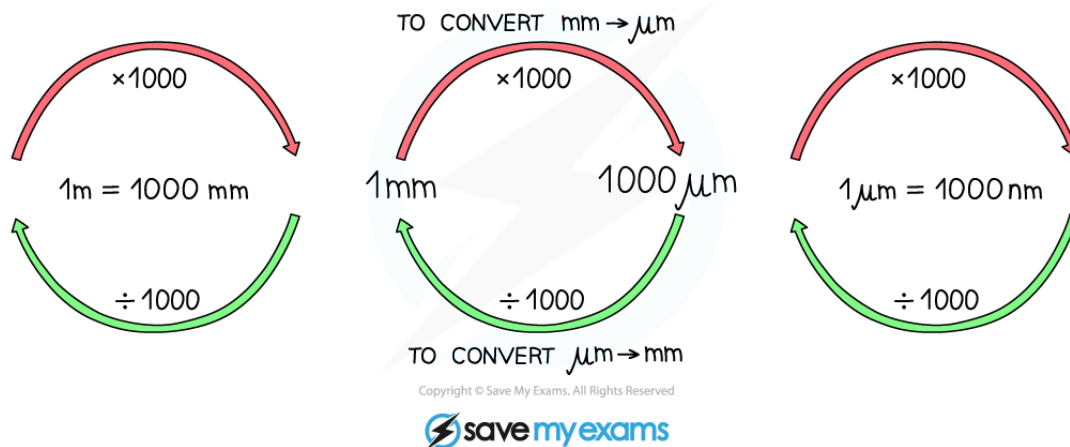

- There are 1000 nanometers (nm) in a micrometre (μm)
- There are 1000 micrometres (μm) in a millimetre (mm)
- There are 1000 millimetres (mm) in a metre (m)

Using a scale bar

- A scale bar is a straight line on the drawing or micrograph that represents the actual size before the image was enlarged
- If the calculation required includes a scale bar on the micrograph or drawing then follow these steps:
 1. Use a ruler to measure the length of the scale bar in millimetres
 2. Convert this measurement into the same units as the number on the scale bar
 3. Insert these numbers into the magnification formula above (note: the size of the image is the measured length of the scale bar and the actual size is the number on the scale bar)



Your notes

 **Worked example**

Calculate the magnification of the transverse section of the leaf blade.

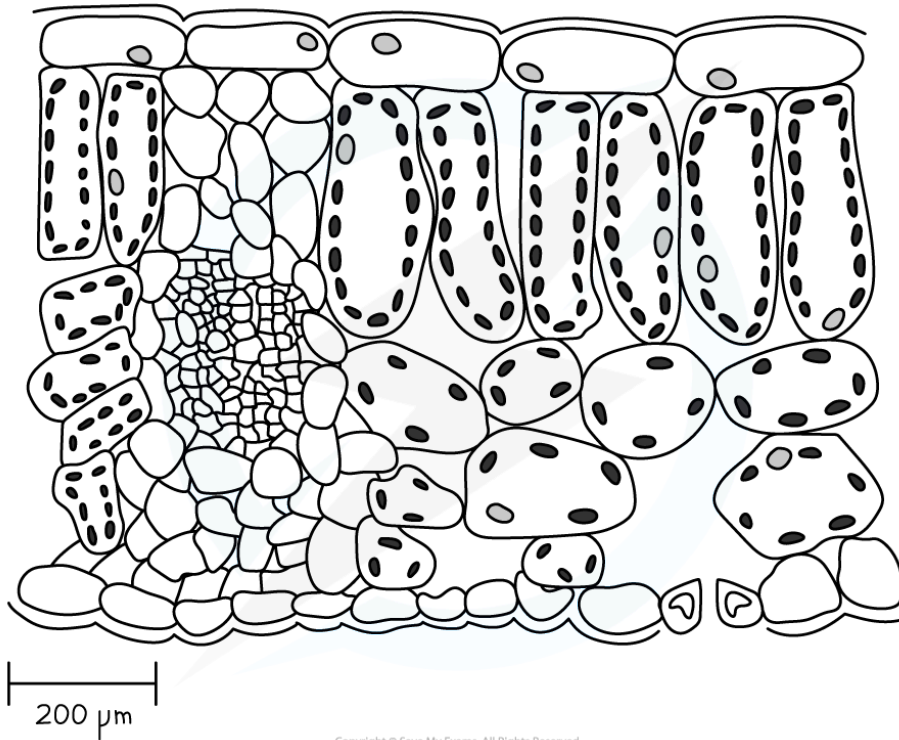

Copyright © Save My Exams. All Rights Reserved

Transverse section of the leaf blade

Step 1: Use a ruler to measure the length of the scale bar in millimetres

Using a ruler the length of the scale bar is equal to 20 mm

Step 2: Convert this measurement into the same units as the number on the scale bar

The units on the scale bar are μm , remember that $1\text{mm} = 1000 \mu\text{m}$

therefore $20 \text{ mm} = 20 \times 1000 = 20\,000 \mu\text{m}$

Step 3: Insert these numbers into the magnification formula

$$\text{Magnification} = \frac{\text{measured length of scale bar}}{\text{scale bar label}}$$

Note: the size of the image is the measured length of the scale bar and the actual size is the number on the scale bar

$$\text{Magnification} = \frac{20\,000\mu\text{m}}{200\mu\text{m}}$$

therefore Magnification = x100



Your notes

Examiner Tip

Before doing any calculations make sure that all the measurements have the same units. When doing the calculations it is easier to write the formula, then rearrange it, before you add any measurements, as this helps avoid any possible errors. Note that when you do calculations using a scale bar, the number on the scale bar is informing you how many mm/ μm or nm the line actually represents (e.g. if the scale bar has 20 nm above it and the line is 10 mm, then every 10 mm on the diagram is **actually** 20 nm).