

## Structured Questions

# Forces & Momentum

Free-Body Diagrams / Newton's First Law / Newton's Second Law / Newton's Third Law / Contact Forces / Non-Contact Forces / Frictional Forces / Hooke's Law / Stoke's Law / Buoyancy / Conservation of Linear Momentum / Impulse & Momentum / Force & Momentum / Collisions & Explosions in One-Dimension / Angular Velocity / Centripetal Force / Centripetal Acceleration / Non-Uniform...

Easy (12 questions)	/137
Medium (13 questions)	/134
Hard (15 questions)	/155
<b>Total Marks</b>	<b>/426</b>

Scan here to return to the course  
or visit [savemyexams.com](https://www.savemyexams.com)

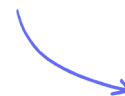

# Easy Questions

- 1 (a) The helicopter below is moving horizontally through still air. The lift force from the helicopter's blades is labelled **A**.

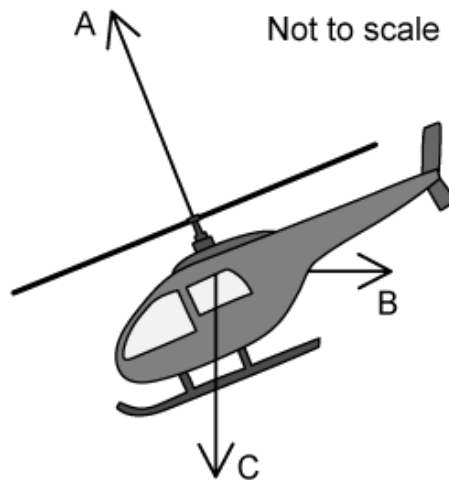

Identify the two forces **B** and **C** that also act on the helicopter.

---

---

(2 marks)

- (b) The force **B** has a value of 25 kN and acts horizontally and at right angles to the weight **C**.

Calculate the horizontal component of force **A** needed to keep the helicopter moving at a constant velocity.

---

(1 mark)

- (c) The helicopter encounters a problem and accelerates vertically downwards towards the ground. It has a mass of 50 000 kg. Air resistance is negligible.

Calculate the weight of the helicopter.

---

---

(2 marks)

(d) State the name of the law of motion that relates to the equation  $F = ma$ .

---

(1 mark)

- 2 (a)** The diagram below shows a ball suspended from a cable. The ball is pulled into the position shown by a rope that is kept horizontal.

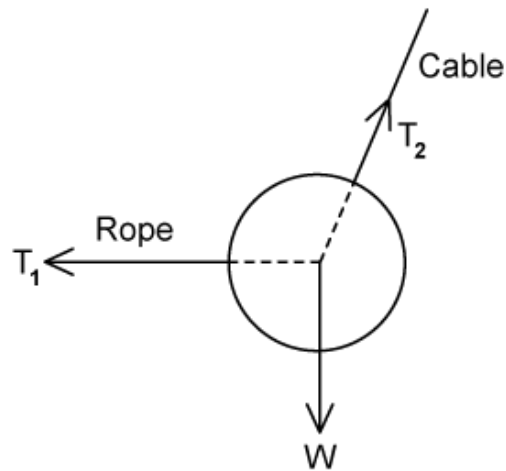

In this position, the ball is in equilibrium.

State the force and component that balance:

- (i) The force of the rope on the ball [1]
- (ii) The weight of the ball [1]

---

---

**(2 marks)**

- (b)** The ball is then detached from the rope, so it is hanging only by the cable. The mass of the ball is 350 kg.

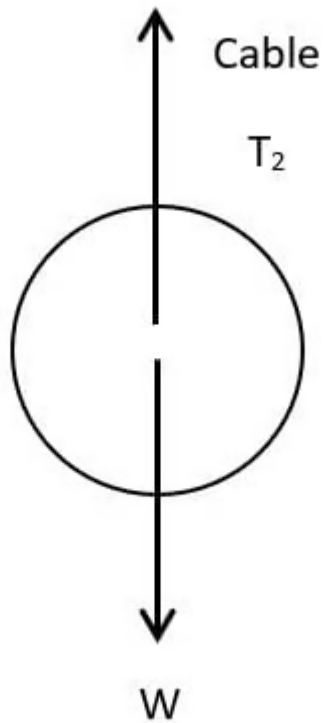

Calculate the new tension in the cable.

---

---

**(2 marks)**

**(c)** The ball is stationary when hanging from the string.

Define translational equilibrium.

---

**(1 mark)**

**(d)** The ball remains hanging and does not fall to the ground.

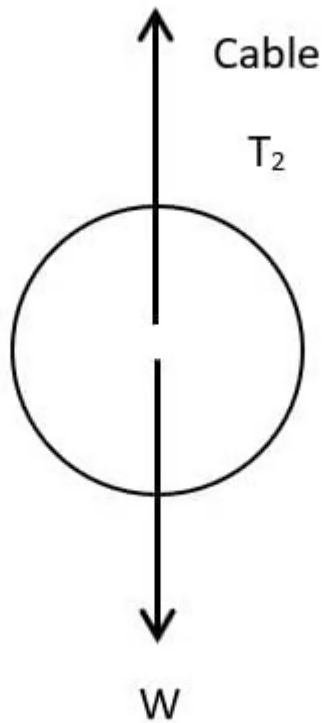

State, in relation to this situation:

- (i) Newton's first law: [1]
- (ii) Newton's second law: [1]
- (iii) The relationship between tension and weight: [1]
- (iv) The behaviour of the ball if the weight was bigger: [2]

.....

.....

.....

.....

.....

**(5 marks)**

3 (a) The diagram below shows a skier being towed at a constant speed whilst sinking into the snow.

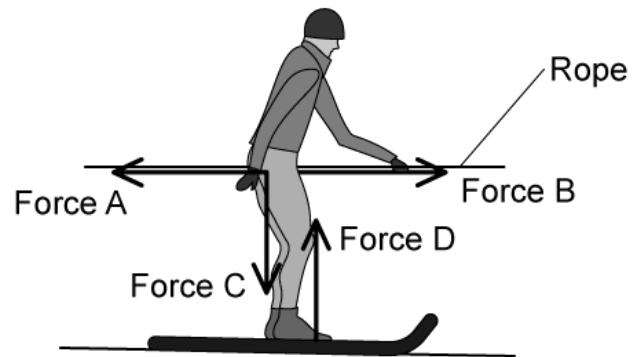

State the name of each of the forces A - D acting on the skier.

.....

.....

.....

.....

(4 marks)

(b) Place a tick (✓) next to the correct statements in the table below:

Force D > Force C	
Force C > Force D	
Force B > Force A	
Force A = Force B	

.....

.....

(2 marks)

(c) The skier is pulled off the snow onto an area of grass and becomes stuck.

State the type of friction present between the bottom of the skis and the grass when she is stationary.

---

**(1 mark)**

(d) The mass of the skier is 52 kg and the coefficient of friction between the skis and the grass is 0.12.

Calculate the minimum force needed from the rope to get the skier just on the point of moving again.

---

---

**(2 marks)**



4 (a) A wooden block is resting on a table as shown.

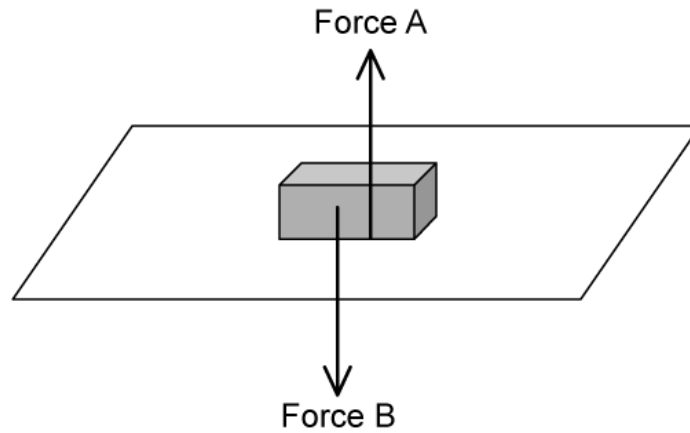

Name the forces **A** and **B** acting on the block.

.....  
.....

**(2 marks)**

(b) A force of 5.8 N is applied to the block to move it along the table at a constant speed.

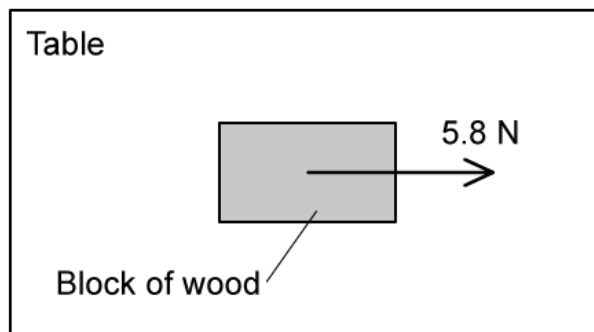

Identify the type of friction now present between the block and the table.

.....

**(1 mark)**

(c) State the magnitude of the frictional force on the block.

.....

**(1 mark)**

(d) The block has a mass of 1.5 kg.

Calculate the magnitude of the dynamic coefficient of friction between the block and the table.

---

---

---

---

**(4 marks)**

- 5 (a) (i) Write an equation for the momentum of an object in words [1]
- (ii) State the fundamental SI units of momentum [1]

.....

.....

**(2 marks)**

(b) A railway carriage,  $C_1$ , of mass 1100 kg is rolling along a horizontal track at a speed of  $6 \text{ m s}^{-1}$  towards a stationary carriage,  $C_2$ , as shown below. Carriage  $C_2$  has a mass of 3300 kg.

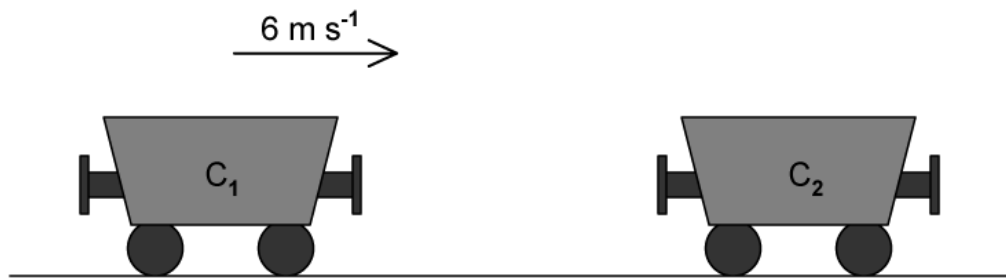

Calculate:

- (i) The initial momentum of carriage  $C_1$  before the collision [2]
- (ii) The initial momentum of carriage  $C_2$  before the collision. [1]

.....

.....

.....

**(3 marks)**

(c) At the moment of collision, both carriages  $C_1$  and  $C_2$ , become joined.

The joined carriages move off with a velocity,  $v$ , as shown below.

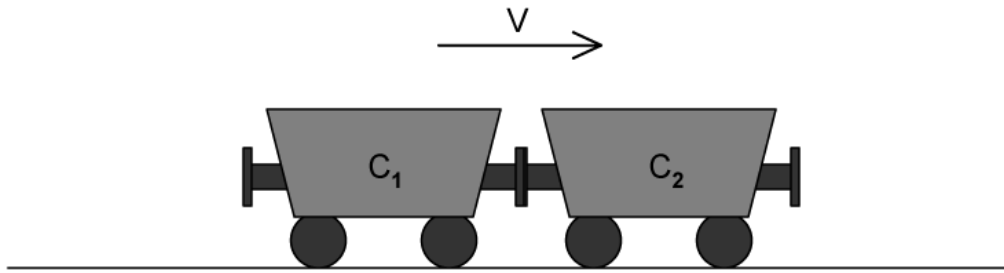

Calculate the total momentum of  $C_1$  and  $C_2$  after they have joined.

Use your answers from part (b) and the conservation of momentum.

---

---

---

**(3 marks)**

**(d)** Calculate the velocity,  $v$ , at which the carriages  $C_1$  and  $C_2$  move after becoming joined.

---

---

---

**(3 marks)**

**6 (a)** A film stuntman, of mass 85.0 kg, is being trained to jump off high objects.

In one scene he steps off a roof and falls vertically to the ground below. Just before he hits the ground he has a velocity of  $9.08 \text{ m s}^{-1}$ . After he has landed on the ground he remains at rest.

Calculate the momentum of the stuntman:

(i) Just before he hits the ground.

[2]

(ii) After he has landed.

[1]

---

---

**(3 marks)**

**(b)** Using your answers to part (a), calculate the change of momentum of the stuntman during the landing.

---

---

**(2 marks)**

**(c)** State the impulse experienced by the stuntman during landing.

Give an appropriate unit with your answer.

---

---

**(2 marks)**

**(d)** When the stuntman keeps his legs fully rigid, the time for the impact is 4.20 ms.

Calculate the magnitude of the average resultant force acting on the stuntman's legs during this time.

---

---

---

---

**(4 marks)**

7 (a) Zorbing is an activity which involves a person running inside an inflatable ball, called a 'zorb'. Two zorbs, A and B, collide head on with each other, as shown. The total mass of zorb A and its occupant is 75 kg and the total mass of zorb B and its occupant is 60 kg. Before the collision, zorb A is travelling at  $2.0 \text{ m s}^{-1}$  and zorb B is travelling at  $1.5 \text{ m s}^{-1}$ .

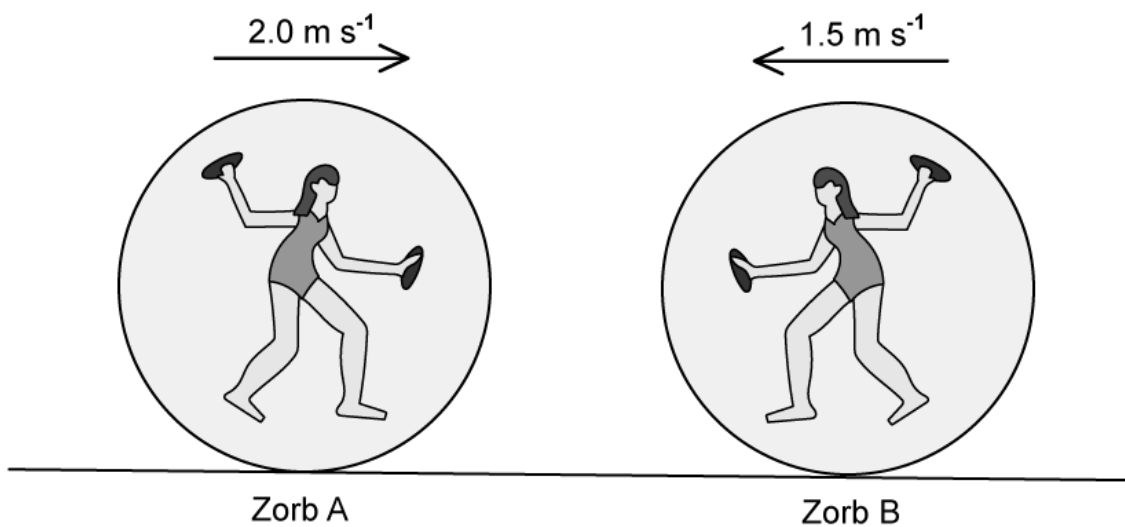

Calculate:

- (i) The momentum of zorb A before the collision [2]
- (ii) The momentum of zorb B before the collision [2]
- (iii) The total momentum of both zorbs before the collision [2]

---



---



---



---



---



---

**(6 marks)**

(b) After the collision, both zorbs bounce off each other and move in opposite directions, as shown below. Zorb A travels at  $0.8 \text{ m s}^{-1}$  and zorb B travels at  $2.0 \text{ m s}^{-1}$ .

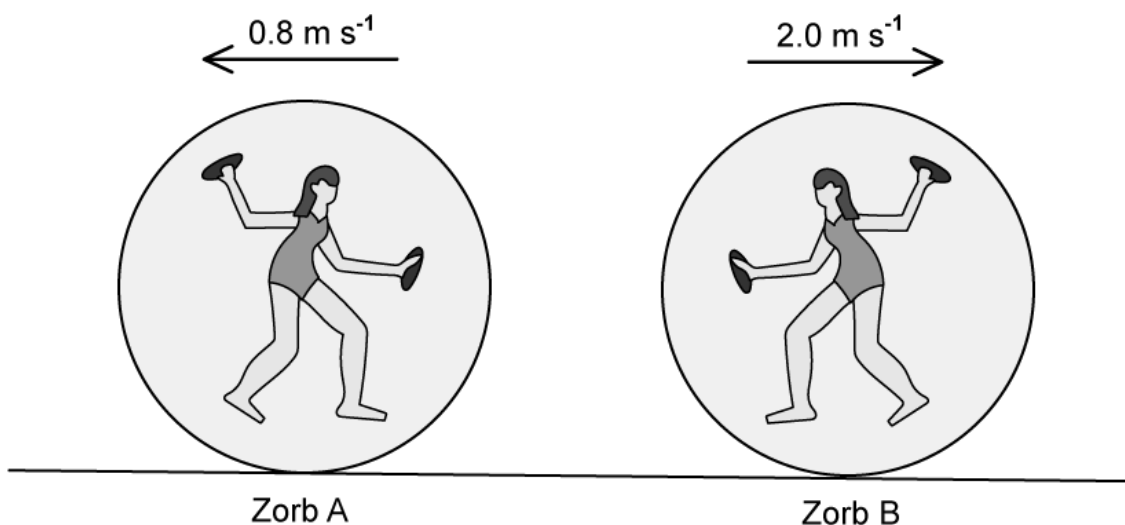

Calculate:

- (i) The momentum of zorb A after the collision [2]
- (ii) The momentum of zorb B after the collision [2]
- (iii) The total momentum of both zorbs after the collision [2]

.....

.....

.....

.....

.....

.....

(6 marks)



**(c)** Calculate:

(i) The total kinetic energy of the zorbs before the collision. [2]

(ii) The total kinetic energy of the zorbs after the collision. [2]

---

---

---

---

**(4 marks)**

**(d)** State whether:

(i) Momentum is or is not conserved during the collision of the zorbs. [1]

(ii) Kinetic energy is or is not conserved during the collision of the zorbs. [1]

(iii) The collision of the zorbs is elastic or inelastic. [1]

---

---

---

**(3 marks)**

- 8 (a)** A collision can be described as being elastic or inelastic. When there are no external forces acting on the collision.

Place a tick (✓) next to the quantities that are conserved in each type of collision,

Quantity	Elastic Collision	Inelastic Collision
Momentum		
Total Energy		
Kinetic Energy		

.....

.....

.....

**(3 marks)**

- (b)** During a safety test, a car of mass 1250 kg travels at  $0.5 \text{ m s}^{-1}$  towards a wall.

Calculate the momentum of the car before it collides with the wall.

.....

**(1 mark)**

- (c)** The car has a force sensor attached to the bumper which detects the force exerted on the front of the car. The graph below shows the variation of force with time for the duration of the collision.

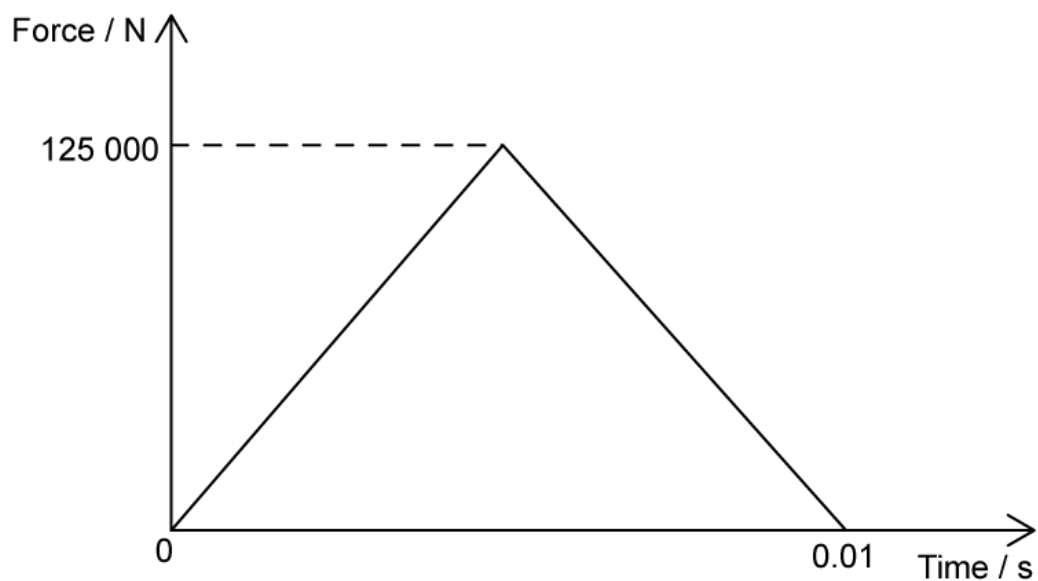

Use the graph to show that the impulse of the collision is 625 N s.

.....

.....

**(2 marks)**

**(d)** All cars are designed with a crumple zone to protect passengers if they are involved in a collision.

State how a crumple zone:

- (i) Affects the impact time of a collision. [1]
- (ii) Affects the force exerted on the car during a collision. [1]

.....

.....

**(2 marks)**

- 9 (a) A bung is attached to a rope and a person swings the bung around their head. The bung moves in a horizontal circular path.

Circle four options from the list below, which are properties of all objects moving in a circle.

Period    Heat energy    Electricity    Frequency    Decay constant  
Angular displacement    Capacitance    Angular speed    Strangeness

.....

.....

.....

.....

**(4 marks)**

- (b) The length of the rope is  $r$ , and the bung is moving with velocity  $v$ . It is acted upon by force  $F$ .

Sketch the shape of the bung's path, labelling  $r$ ,  $v$  and  $F$ .

.....

.....

.....

**(3 marks)**

- (c) The bung travels through an angular displacement of  $\frac{\pi}{8}$  rad.

Convert the angular displacement into degrees.

.....

.....

.....

**(3 marks)**

(d) It takes 0.5 s for the bung to complete one revolution. The radius of its circular path is 0.75 m.

(i) Calculate the angular speed of the bung.

[4]

(ii) Calculate the linear speed of the bung.

[2]

---

---

---

---

---

---

---

---

**(6 marks)**

**10 (a)** A car is moving with uniform circular motion and experiences a centripetal force.

(i) Define centripetal force.

[3]

(ii) State the type of force which is responsible for the centripetal force on the car.

[1]

---

---

---

---

**(4 marks)**

**(b)** The car has mass 500 kg and is travelling around a roundabout with a linear speed of 9 m s<sup>-1</sup>. The radius of the roundabout is 12 m.

Determine the centripetal force acting on the car.

---

---

**(2 marks)**

**(c)** The car proceeds to another roundabout which has radius 20 m. The angular speed of the car at this roundabout is 0.2 rad s<sup>-1</sup>.

Calculate the centripetal acceleration of the car around this roundabout.

---

---

**(3 marks)**

**(d)** At this second roundabout, the car is travelling at the maximum speed possible before it would skid. The coefficient of static friction determines the maximum speed possible and

is given by  $\mu_s = \frac{\omega^2 r}{g}$ , where  $\omega$  is the angular speed,  $r$  is the radius of the roundabout, and  $g$  is the acceleration due to gravity.

Determine the co-efficient of static friction between the tyres and the road.

---

---

**(2 marks)**

**11 (a)** A planet orbits a star in 260 Earth days, which is 22 464 000 s.

(i) State the angular displacement of the planet in 260 days, giving an appropriate unit with your answer. [2]

(ii) Calculate the angular speed of the planet. [4]

.....

.....

.....

.....

.....

.....

**(6 marks)**

**(b)** The linear speed of the planet is  $35\,000\text{ m s}^{-1}$ .

Calculate the radius of the planet's orbit.

.....

.....

**(2 marks)**

**(c)** The planet has a mass of  $2.7 \times 10^{24}\text{ kg}$  and stays in orbit due to a centripetal force.

Calculate the centripetal force required to keep the planet in orbit.

.....

.....

**(2 marks)**



(d) The planet experiences a centripetal acceleration.

(i) Define uniform centripetal acceleration

[3]

(ii) Determine the centripetal acceleration experienced by the planet.

[2]

---

---

---

---

---

---

**(5 marks)**

**12 (a)** A fairground ride is moving with uniform circular motion.

(i) Define angular displacement.

[2]

(ii) Define angular speed.

[1]

---

---

---

**(3 marks)**

**(b)** A child on the ride has an angular displacement of  $\frac{\pi}{2}$  rad and angular speed of  $0.3 \text{ rad s}^{-1}$ .

Calculate the time required for the child to have this angular displacement.

---

---

---

---

**(4 marks)**

**(c)** The radius of the ride is 8 m and the child's mass is 35 kg.

Determine the centripetal force on the child.

---

---

**(2 marks)**

- (d) (i) Calculate the child's linear speed. [2]
- (ii) Calculate the child's centripetal acceleration. [2]

---

---

---

---

**(4 marks)**

# Medium Questions

- 1 (a) Ric is standing in an elevator and has a mass of 68 kg. The elevator is moving upwards at a speed of  $2.5 \text{ m s}^{-1}$  and comes to rest 3.0 s later.

Calculate the reaction force on Ric from the elevator floor during the time it takes the elevator to come to rest.

---

---

---

---

**(4 marks)**

- (b) Ric realises that he forgot his lab coat on the floor below. He again travels in the elevator which goes downwards at the same speed, coming to rest in the same time.

Calculate the reaction force on Ric from the elevator floor during the time it takes to come to rest at the floor below.

---

---

---

**(3 marks)**

- (c) Hence, deduce which deceleration period of the elevator would make Ric feel:

- (i) Lighter
- (ii) Heavier

---

---

**(2 marks)**

- (d)** In a serious stroke of bad luck, the elevator cable snaps and it falls freely. Ric experiences a sense of weightlessness.

Explain, using appropriate laws of motion, why Ric feels a sense of weightlessness in this situation.

---

---

---

**(3 marks)**

- 2 (a) A flower pot of mass 15 kg hangs from two strings attached to the ceiling with tensions A and B, where it remains in equilibrium.

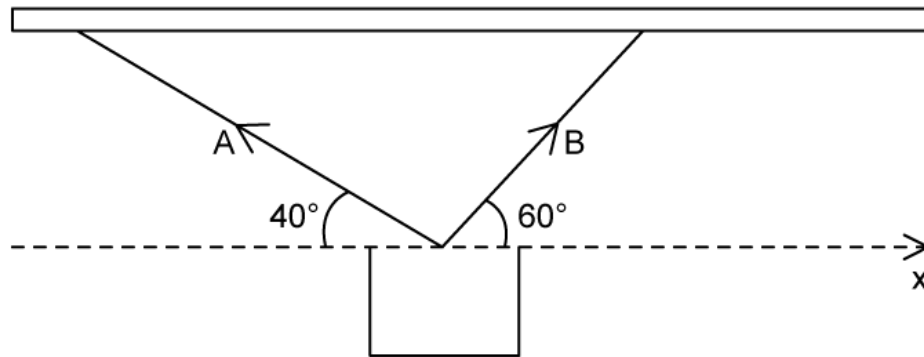

Derive two equations for A in terms of B. Give any values to an appropriate number of significant figures.

.....

.....

.....

.....

**(4 marks)**

- (b) Hence, calculate tensions A and B.

.....

.....

.....

.....

**(4 marks)**

- (c) A gardening enthusiast wants to hang a flower pot from two strings on the ceiling of their balcony. They have two pieces of string, but they are unfortunately quite old and frayed.

Suggest and explain how they can attach the strings to the flower pot in order for them to stay intact.

---

---

**(2 marks)**

- 3 (a)** A stone block is pulled at constant speed up an incline by a cable attached to an electric motor.

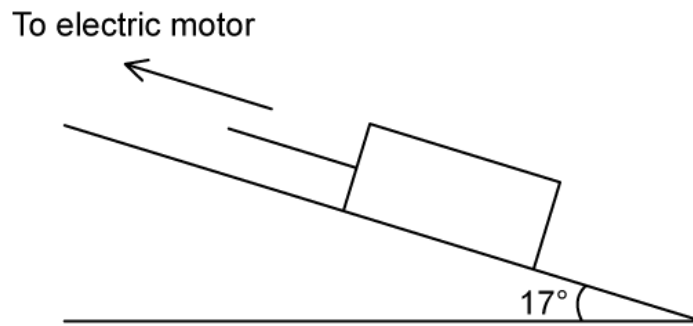

The incline makes an angle of  $17^\circ$  with the horizontal. The mass of the block is 180 kg and the tension  $T$  in the cable of 0.9 kN.

On the diagram draw and label arrows that represent the forces acting on the block.

.....

.....

**(2 marks)**

- (b)** State the type of friction in this system and calculate the frictional force.

.....

.....

.....

.....

**(4 marks)**

- (c)** Hence, calculate the appropriate coefficient of friction.

.....

.....

.....



**(3 marks)**

**(d)** The cable connecting the block to the electric motor abruptly breaks.

Calculate the acceleration of the block.

---

---

---

**(3 marks)**

- 4 (a) Show, using the equation  $F = ma$ , how the impulse of a force  $F$  is related to the change in momentum  $\Delta p$  that it produces for a mass  $m$  with acceleration  $a$ .

---

---

(2 marks)

- (b) A railway truck on a level, straight track is initially at rest. The truck is given a quick, horizontal push by an engine so that it now rolls along the track.



The engine is in contact with the truck for a time  $T = 0.60$  s and the initial speed of the truck after the push is  $5.5 \text{ m s}^{-1}$ . The mass of the truck is  $3.1 \times 10^3$  kg.

Due to the push, a force of magnitude  $F$  is exerted by the engine on the truck. The sketch shows how  $F$  varies with contact time  $t$ .

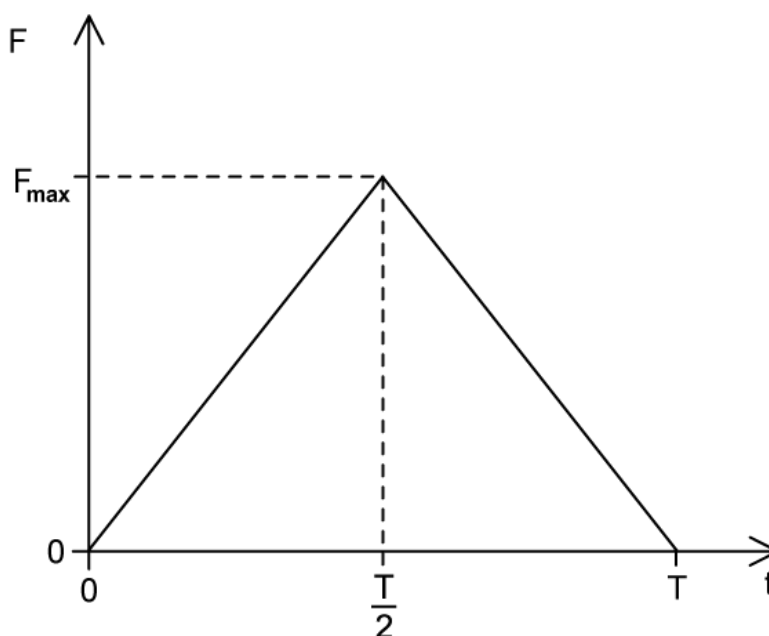

Determine the magnitude of the maximum force exerted by the engine on the truck.

---

---

---

---

**(4 marks)**

**(c)** When the speed of the truck is  $2.3 \text{ m s}^{-1}$ , it collides with a stationary truck of mass  $4.7 \times 10^3 \text{ kg}$ . The two trucks move off together with a speed  $V$ .

Show that the speed  $V = 0.9 \text{ m s}^{-1}$

---

---

---

---

**(4 marks)**

**(d)** State and explain whether the collision of the two trucks is elastic or inelastic.

---

---

**(2 marks)**

- 5 (a) Two identical blocks A and B of mass 200 g are travelling towards each other along a straight line through their centre. Assume that the surface is frictionless.



Both blocks are moving at a speed of  $0.21 \text{ m s}^{-1}$  relative to the surface.

As a result of the collision, the blocks reverse their direction of motion and travel at the same speed as each other. During the collision, 30% of the kinetic energy of the blocks is transferred to the surroundings as thermal energy.

Deduce whether the collision is elastic or inelastic and state your reasoning.

.....  
.....

**(2 marks)**

- (b) Calculate the final speed of the blocks relative to the surface.

.....  
.....

**(2 marks)**

- (c) The duration of the collision between the blocks is 650 ms.

Determine the average force one block exerted on the other.

.....  
.....

**(2 marks)**

6 (a) The force acts on a mass of 5.0 kg initially at rest.

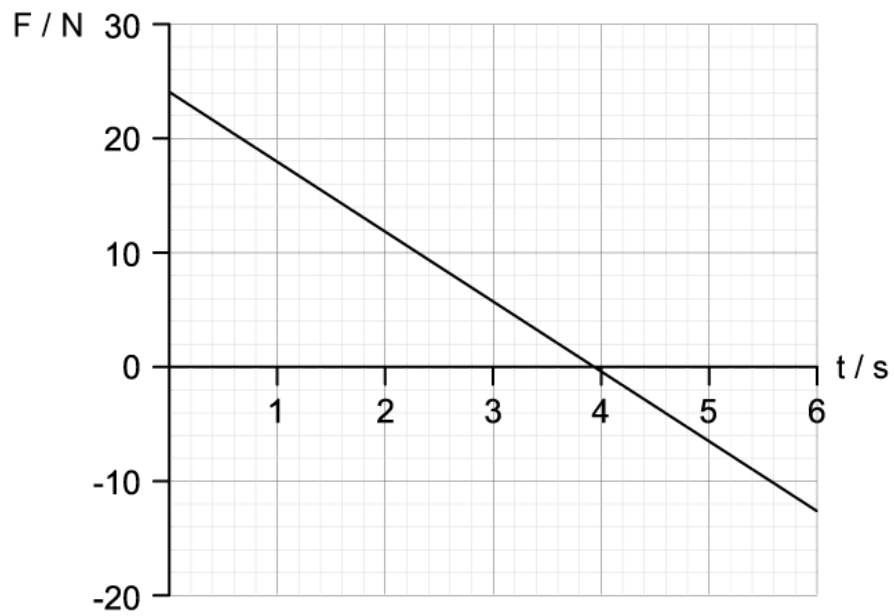

Show that the speed of the mass at  $t = 3 \text{ s}$  is  $9.0 \text{ m s}^{-1}$ .

.....

.....

.....

.....

**(4 marks)**

(b) Calculate the deceleration of the mass up to time  $t = 4 \text{ s}$ .

.....

.....

.....

**(3 marks)**

(c) Calculate the total impulse experienced by the mass.

.....

---

---

**(3 marks)**

**(d)** Outline the motion of the mass as indicated by the graph.

---

---

**(2 marks)**

- 7 (a) A space rocket is moving with constant velocity. The engines of the space rocket are turned on and it accelerates by burning fuel and ejecting gases.

Discuss how the law of conservation of momentum allows the space rocket to accelerate forward, although it ejects gases in the opposite direction.

---

---

---

(3 marks)

- (b) A rocket is travelling at constant velocity in space after exiting the Earth's atmosphere. The engines are turned off, and a module separates from the rocket.

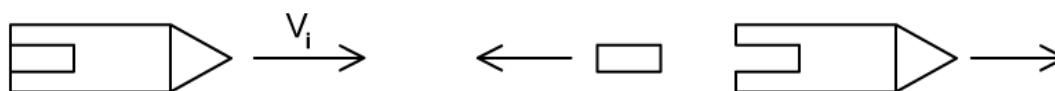

The module has a mass of 6 000 kg and is ejected at  $10 \text{ km s}^{-1}$ . The combined mass of the rocket and the module is 81 000 kg and the remaining part of the rocket after the explosion travels at  $4500 \text{ m s}^{-1}$  after the module has been ejected.

Calculate the initial speed of the rocket.

---

---

---

---

(4 marks)

- (c) Calculate the force exerted on the module in 0.2 s during the explosion.

---

---

---

**(3 marks)**

- (d)** Inside the rocket, some walls are padded to reduce damage to its interior when it is accelerated into space.

Explain, with reference to change in momentum, why padded walls are less likely to cause damage to the interior of the rocket compared to a rigid wall.

.....

.....

**(2 marks)**



- 8 (a)** Joanna and Lindsay are two roller skaters initially at rest on a horizontal surface. They are facing each other and Joanna is holding a ball. Joanna throws the ball to Lindsay who catches it. The speed at which the ball leaves Joanna, measured relative to the ground, is  $6.2 \text{ m s}^{-1}$ .

The following data are available.

Mass of Joanna = 59 kg

Mass of Lindsay = 64 kg

Mass of ball = 3.3 kg

- (i) Calculate the velocity  $v$  of Joanna relative to the ground immediately after she throws the ball

[3]

- (ii) State the direction that Joanna travels in after she throws the ball

[1]

.....

.....

.....

.....

**(4 marks)**

- (b)** Calculate the speed  $V$  of Lindsay relative to the ground immediately after she catches the ball. Assume the speed of the ball stays constant throughout its motion.

.....

.....

.....

.....

**(4 marks)**

(c) Determine whether Lindsay catching the ball is an elastic or inelastic collision.

---

---

---

**(3 marks)**

(d) Lindsay has a previous injury to her hand, so decides to wear padded gloves whilst playing this game with Joanna. This is similar to what players would wear in cricket if they need to catch a ball at high speed.

Explain why the padded gloves would protect Lindsay's hands when she catches the ball.

---

---

**(2 marks)**

- 9 (a) A lead ball of mass 0.55 kg is swung round on the end of a string so that the ball moves in a horizontal circle of radius 1.5 m. The ball travels at a constant speed of  $6.2 \text{ m s}^{-1}$ .

Calculate the time taken for the string to turn through an angle of  $170^\circ$ .

---

---

---

**(3 marks)**

- (b) Calculate the tension in the string.

---

---

**(2 marks)**

- (c) The string will break when the tension exceeds a maximum tension. The ball makes three revolutions per second at the maximum tension of the string.

Calculate the tension above which the string will break.

---

---

**(2 marks)**

- (d) Describe, using just one of Newton's Laws, why the ball is accelerating even when its angular speed is constant.

You may wish to draw a diagram to clarify your answer.

---

---

---

**(3 marks)**

10 (a) Explain why a particle moving in a circle with uniform speed is accelerating.

---

---

(2 marks)

(b) The diagram shows the final section of a roller coaster which ends in a vertical loop. Cars on the roller coaster descend to the start of the loop and then travel around it.

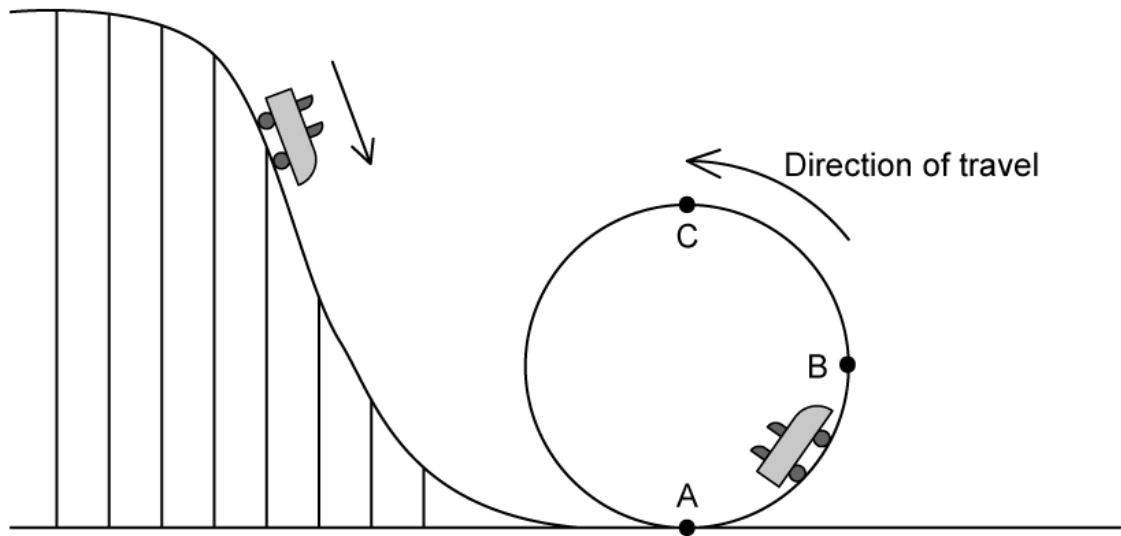

As the passengers move around the circle from **A** to **B** to **C**, the reaction force between exerted by their seat varies.

State the position at which this force will be a maximum and the position at which it will be a minimum. Explain your answers.

---

---

---

---

(4 marks)

- 11 (a) A centrifuge is often used in astronaut training. This is to simulate Earth's gravity on board the space station. The astronauts sit in a cockpit at the end of each arm, each rotating about an axis at the centre.

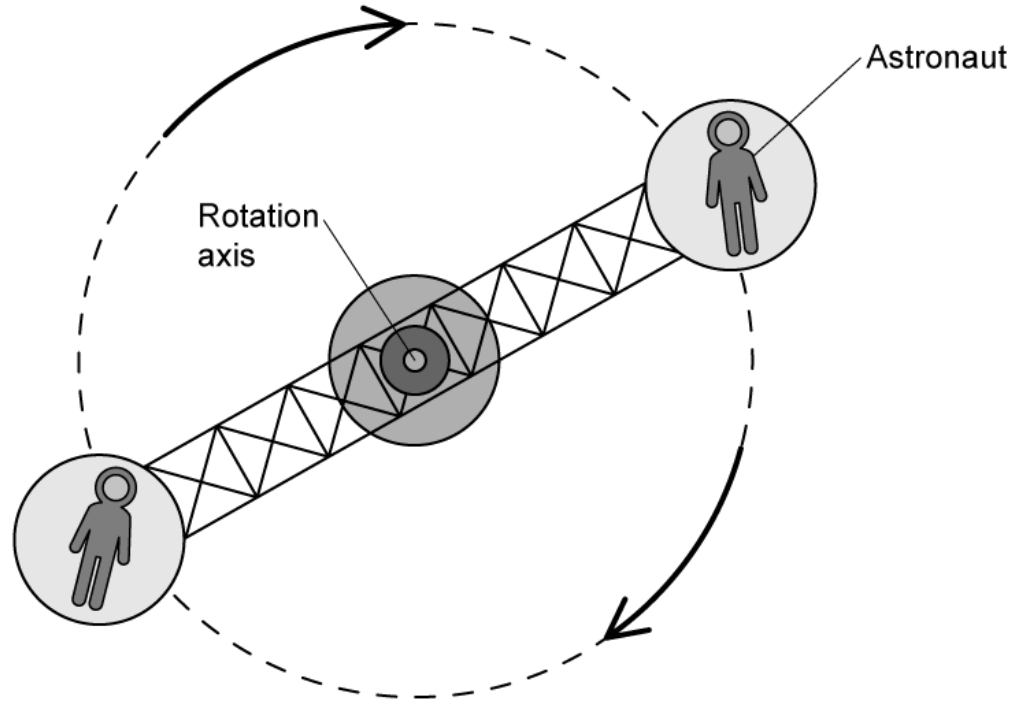

At its top speed, the centrifuge makes 1 full rotation every 2.30 s.

Calculate the frequency of the centrifuge. State an appropriate unit and express your answer to an appropriate number of significant figures.

---

---

---

(3 marks)

- (b) Calculate the angular speed of the centrifuge in  $\text{rad s}^{-1}$ .

---

---

(2 marks)

(c) Each astronaut is placed 6.30 m from the rotation axis.

Calculate the magnitude of the centripetal acceleration on each astronaut.

---

---

**(2 marks)**

(d) Sketch the direction of the acceleration on each astronaut.

---

**(1 mark)**

**12 (a)** A section of a roller coaster carries a passenger over a curve in the track. The radius of curvature of the path of the passenger is  $r$  and the roller coaster is travelling at constant speed  $v$ . The mass of the passenger is  $m$ .

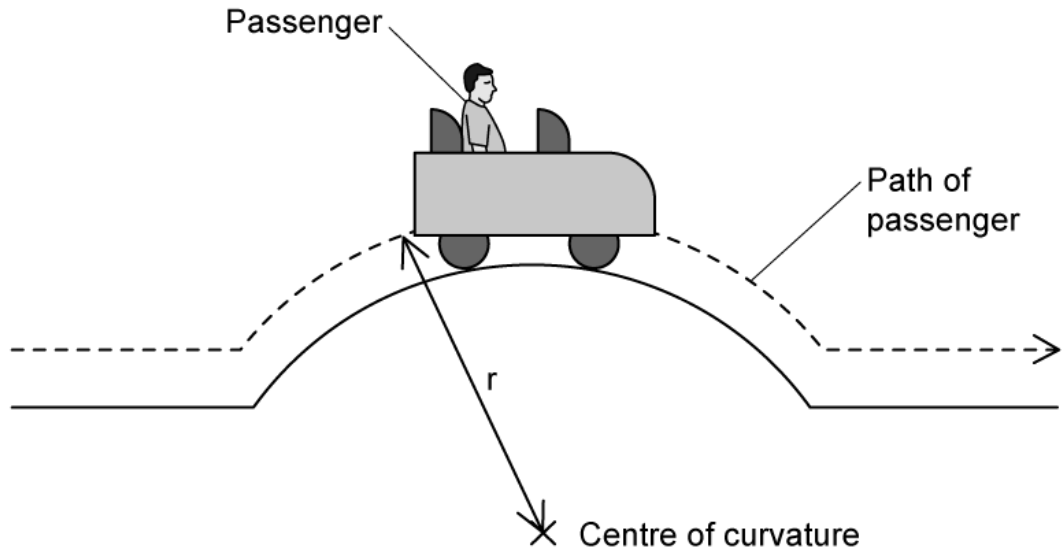

- (i) Draw the forces that act on the passenger as they pass over the highest point on the curved track.
- (ii) Write down an equation that relates the contact force  $R$  between the passenger and the seat to  $m$ ,  $v$ ,  $r$  and the gravitational field strength,  $g$ .

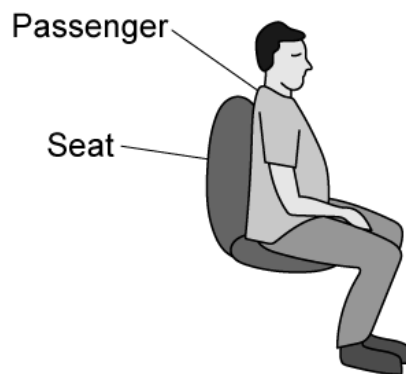

---



---

**(2 marks)**

- (b) At a particular point on the track, the car moves with a linear velocity of  $22 \text{ m s}^{-1}$ . The reaction force between the car and the track at this point is  $210 \text{ N}$  and the passenger has a mass of  $65 \text{ kg}$ .

Calculate the distance from the passenger to the centre of curvature of the curved track.

---

---

---

**(3 marks)**

- (c) State and explain what would happen to the magnitude of  $R$  if the rollercoaster passed over the curved track at a higher speed.

---

---

**(2 marks)**

- (d) When the rollercoaster passes over a curved section of a track above a certain speed, the passenger is momentarily lifted off their seat and experiences weightlessness.

Calculate the speed at which the rollercoaster must be travelling for the passenger to experience weightlessness.

---

---

---

**(3 marks)**



- 13 (a) The London Eye shown in the diagram has a radius of approximately 68 m and the passengers in the capsules travel at an angular speed of  $3.5 \times 10^{-3} \text{ rad s}^{-1}$ .

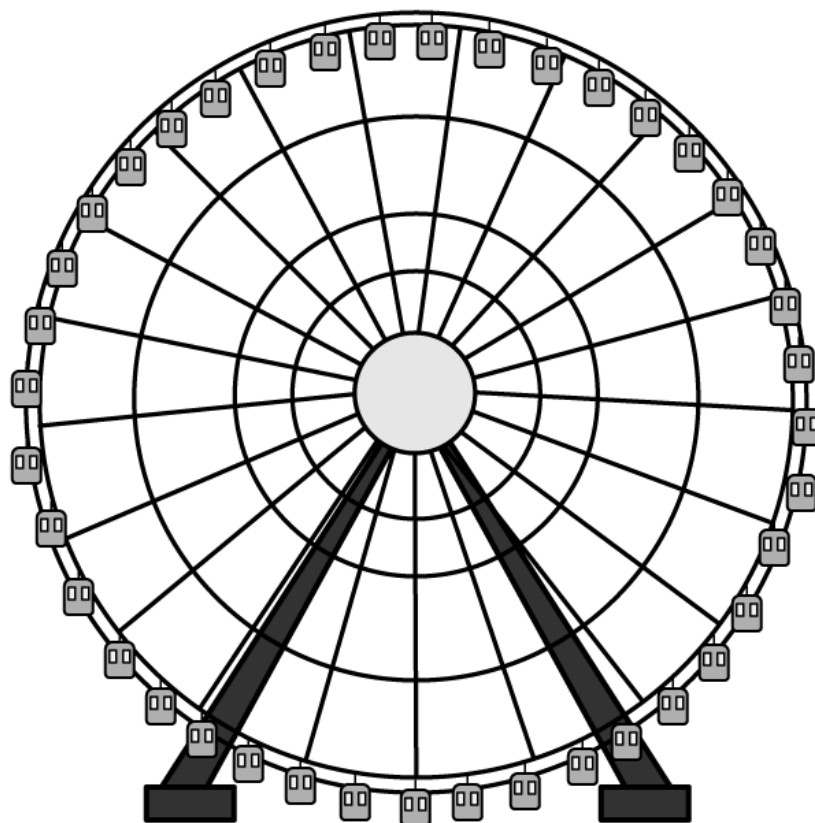

Calculate the speed of each passenger in the capsules.

---

---

(2 marks)

- (b) Assume the London Eye is rotating clockwise.

Sketch the following on any capsule:

- (i) The direction of the centripetal force  $F$
- (ii) The direction of the linear speed  $v$ .

---

---

**(2 marks)**

- (c)** Each capsule weighs about 98.1 kN.

Calculate the centripetal force on an empty capsule.

---

---

---

**(3 marks)**

- (d)** Dan has travelled to London to watch an exciting Physics show. Being an eager tourist, he arrives early and plans to ride the London Eye. When he gets to the front of the queue however, he realises he only had 40 minutes before he needs to leave for the show.

State, with a calculation, whether Dan is still able to ride the London Eye and leave to see the show on time.

---

---

---

---

**(4 marks)**

# Hard Questions

1 (a) A sun bather is supported in water by a floating sun bed.

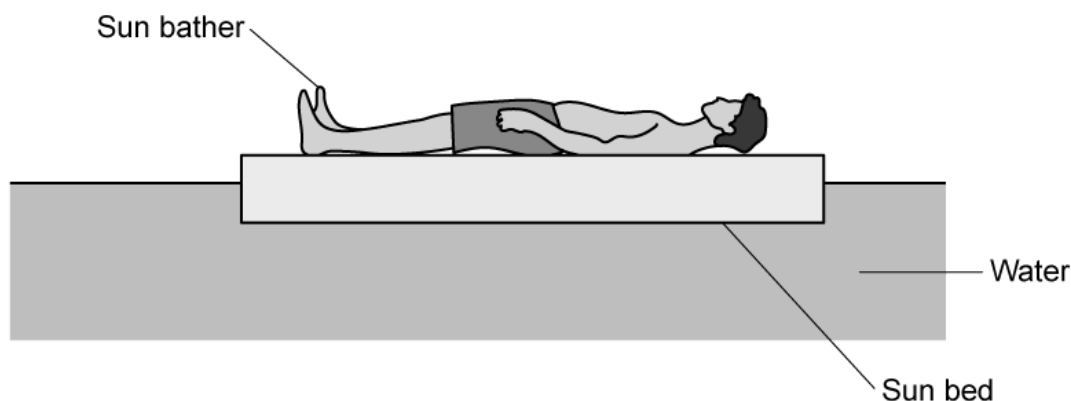

Draw and label vectors representing the forces acting on the sun bed.

.....

.....

.....

.....

**(4 marks)**

(b) The sunbather has incredible core strength and balance.

They stand upright at one end of the sun bed and begin to walk forwards at a constant velocity to the right.

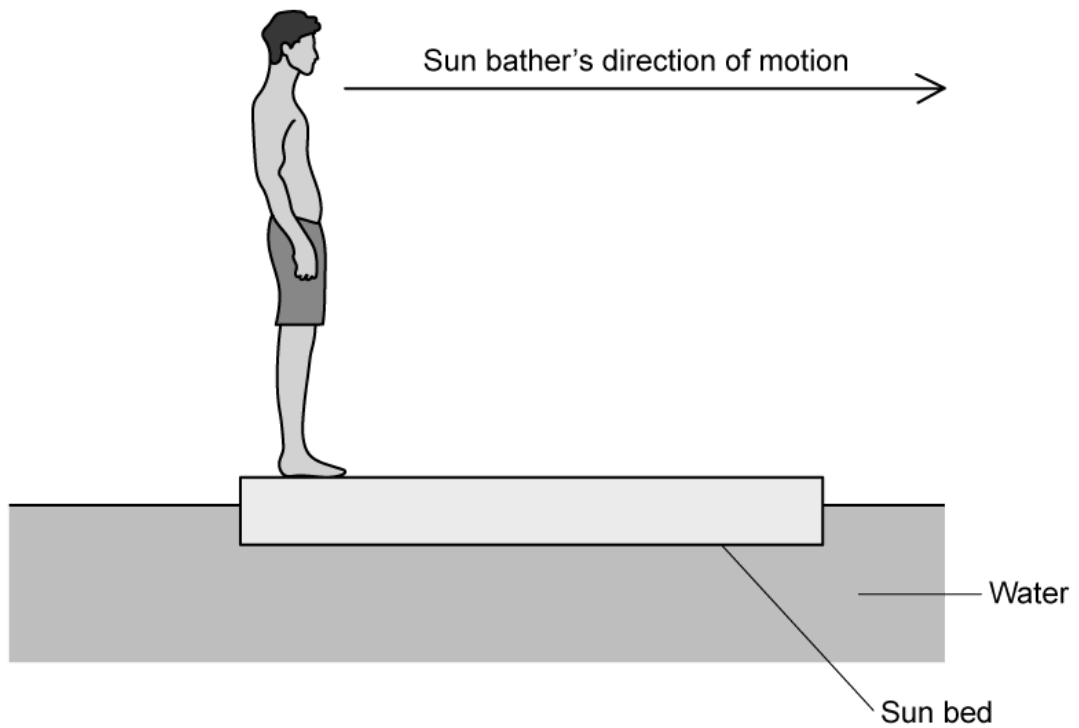

(i) Describe the magnitudes and directions of the forces acting between the sunbather and the sun bed

[4]

(ii) Hence, explain the consequent motion of the sun bed.

[2]

.....

.....

.....

.....

.....

.....

**(6 marks)**

(c) The sun bed and sunbather may be treated as a single, isolated system.

(i) Explain how the sun bed and sunbather may be considered as a 'single' system [1]

(ii) Explain how the single system may be considered as 'isolated'. [1]

---

---

**(2 marks)**

2 (a) Describe the microscopic origin of static friction between two objects.

.....  
.....

**(2 marks)**

(b) Compare and contrast the static force of friction and the dynamic force of friction.

.....  
.....  
.....

**(3 marks)**

(c) A block of mass 2.5 kg is at rest on a rough inclined plane. The block just begins to slip down the plane when the angle of inclination is 35°.

Calculate the coefficient of static friction between the block and the inclined plane.

You may use the following result:

$$\tan \theta = \frac{\sin \theta}{\cos \theta}$$

.....  
.....  
.....

**(3 marks)**

(d) The angle of inclination is increased to  $40^\circ$ .

Calculate the force that must be applied to the block to move it up the plane with an acceleration of  $1.5 \text{ m s}^{-2}$ .

Use the following data:

- $\mu_d = 0.30$

---

---

---

**(3 marks)**

3 (a) A ball travels in a circular path on the inside surface of a bowl.

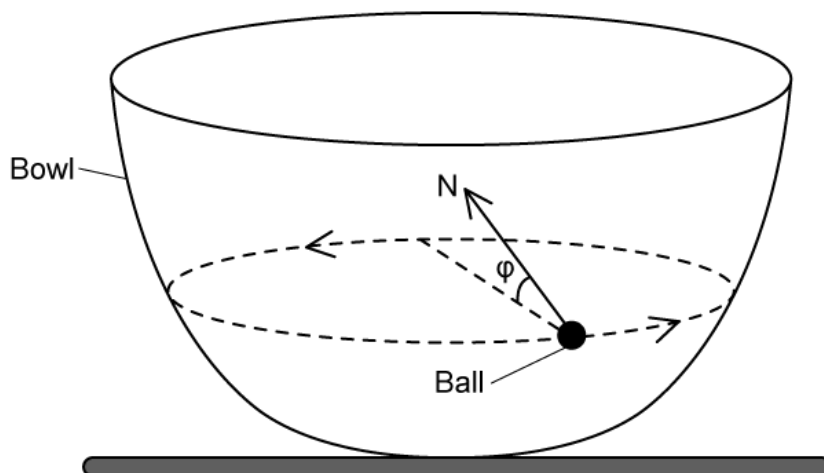

The normal reaction force  $N$  makes an angle  $\phi$  to the plane of the ball's path. Ignore the effects of friction.

On the free-body diagram below, construct an arrow to represent the weight of the ball.

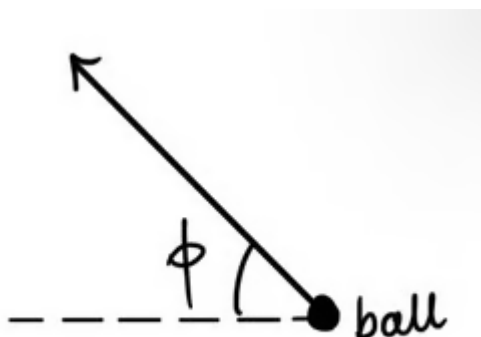

---

---

---

(3 marks)

(b) Determine an equation for the resultant force acting on the ball in terms of its mass  $m$  and the angle to its plane of orbit  $\phi$ .



You may use the result:

$$\tan \phi = \frac{\sin \phi}{\cos \phi}$$

.....

.....

**(2 marks)**

**(c)** The radius of the ball's orbit decreases.

Explain how the effects of friction are related to the decreasing orbital radius.

.....

.....

.....

**(3 marks)**

**(d)** Outline if the ball could travel along a horizontal circular path with an orbital radius equal to the maximum radius of the bowl. Ignore the effects of friction in your answer.

.....

.....

.....

**(3 marks)**

- 4 (a) A woman stands in an elevator and measures the weight of a fish attached to a spring scale. The scale reads 40 N when the elevator is stationary.

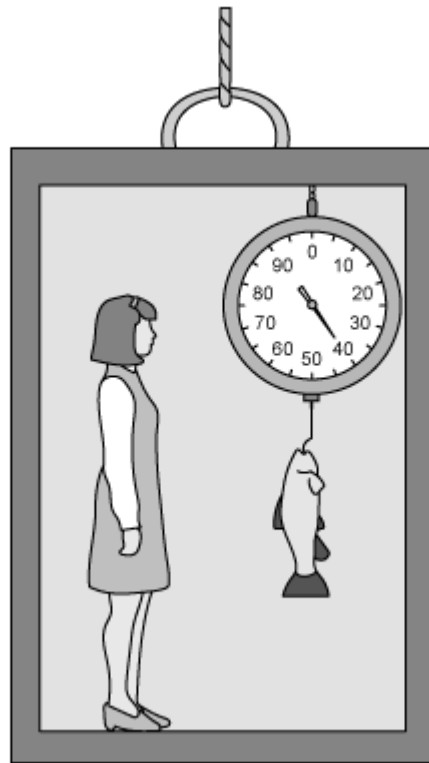

Sketch the reading on the spring scale as the lift gently accelerates upward.

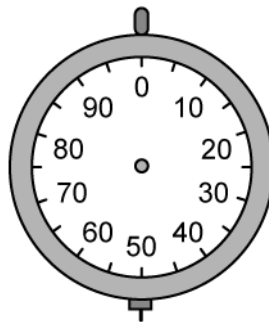

(2 marks)

(b) As the elevator continues moving upwards, it gently decelerates to a standstill.

Draw and label a free-body force diagram for the fish as the elevator gently decelerates.

---

---

(2 marks)

(c) The rope that attaches the spring scale to the ceiling of the elevator suddenly snaps. The spring scale and the fish are momentarily in free-fall – but the observer manages to take a reading from the scale it falls.

State and explain the reading on the spring scale as it falls.

---

---

(2 marks)

(d) Sketch the variation of the contact force on the observer's feet as the elevator decelerates to rest on the axes provided.

The magnitude of the observers weight,  $mg$ , is included as a dashed line, for reference.

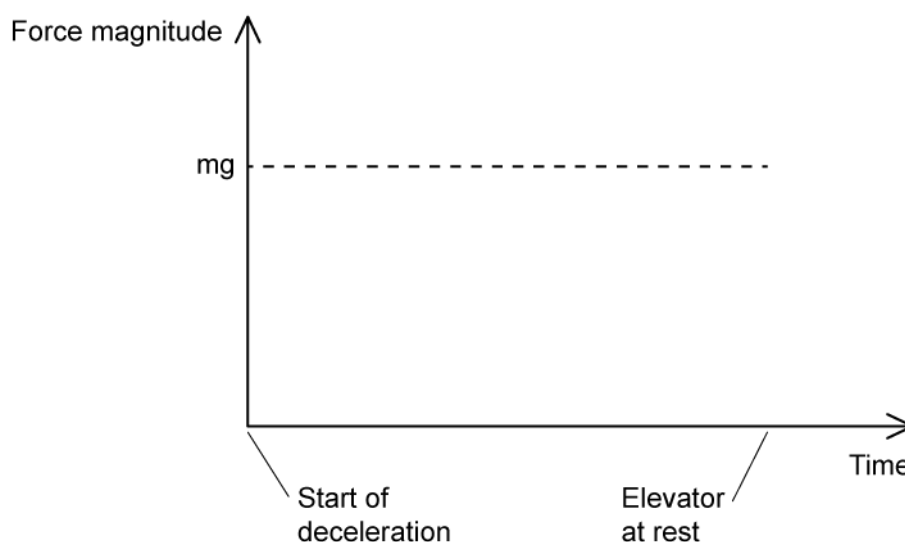

---

---

---

**(3 marks)**

- 5 (a) Two blocks of mass 4.5 kg and 6.0 kg are joined by a string and rest on a smooth horizontal table. A force  $F$  of 100 N is applied to one of the blocks.

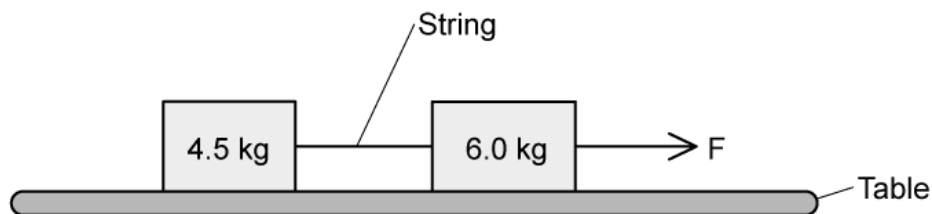

Calculate

- (i) The acceleration of the blocks [1]
- (ii) The tension in the string. [1]

---

---

(2 marks)

- (b) The 4.5 kg block is now placed on top of the 6.0 kg block. The coefficient of static friction between them is 0.40.

Calculate the maximum horizontal force  $F$  that can be applied to the bottom block that would result in both blocks moving together without slipping.

---

---

---

(3 marks)

- (c) The two blocks are now attached by a light inextensible string that passes over a smooth pulley. They are held stationary and suddenly released.

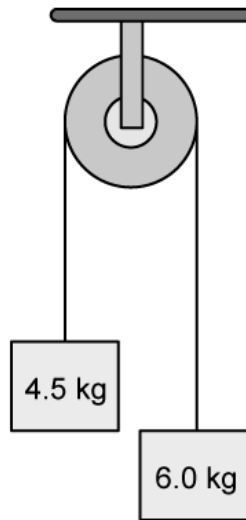

Determine the acceleration of each block and the tension in the string.

---

---

---

---

**(4 marks)**

**(d)** The string attaching the blocks over the pulley in part (c) suddenly snaps.

Describe and explain the subsequent motion of the block of mass 4.5 kg. (Assume it was moving upward at the instant the string snapped).

---

---

**(2 marks)**

- 6 (a)** Air enters a cargo plane's engine at A and is heated before leaving at B, at a much higher speed.

The rotating blades draw air in and while in the engine, the air is compressed and mixed with fuel, combusted and shot out the back of the engine.

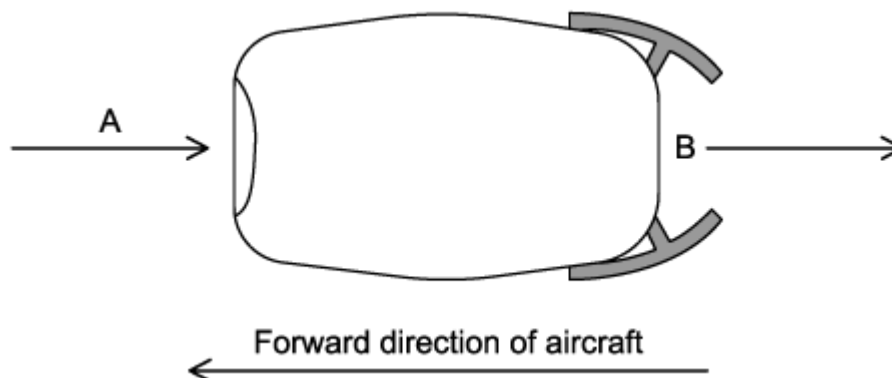

In one second a mass of  $3.75 \times 10^5$  g of air enters A and the speed of this mass of air increases by  $587 \text{ m s}^{-1}$  as it passes through the engine.

Calculate the force exerted by the air on the engine.

.....  
(1 mark)

- (b)** Hot air flows out of the exhaust engine at B through a cross-sectional area of  $5.9 \times 10^6$  mm<sup>2</sup>. The density of the hot air is  $457.9 \text{ g m}^{-3}$ .

Calculate the volume of air leaving the engine every second.

.....  
(2 marks)

- (c)** Explain, referring to the momentum of the air as it passes through the engine and using appropriate laws of motion, why it exerts a force on the engine in a forward direction.

(3 marks)

- (d) When a cargo plane lands its engines exert a decelerating force on the aircraft by making use of deflector plates. These cause the air leaving the engines to be deflected at an angle to the direction the aircraft is travelling.

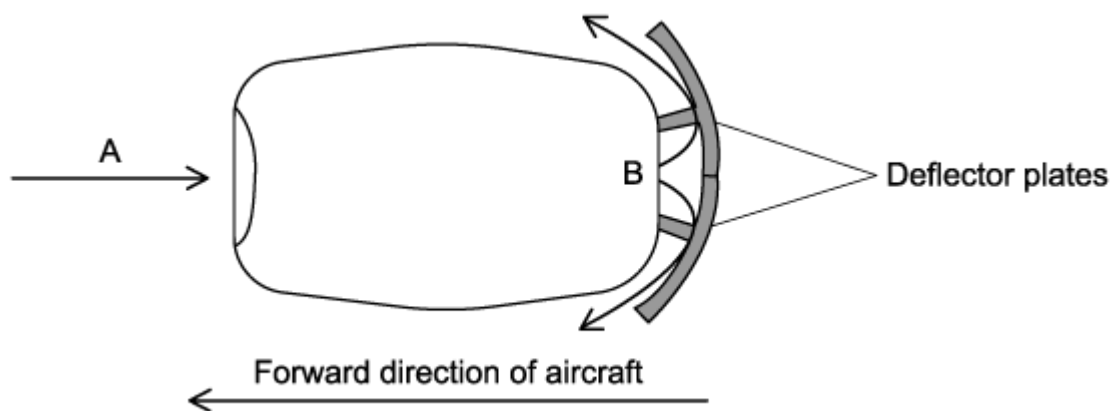

The speed of the deflected air is the same as the speed of the air leaving B.

- (i) Explain why the momentum of the air changes. [2]
- (ii) Suggest why the decelerating force provided by the deflector plates may not remain constant. [2]

.....

.....

.....

.....

(4 marks)



- 7 (a) A squash ball is raised from the ground and dropped onto a hard plate to test its properties. A sensor measured the force exerted by the plate on the ball during its collision with the plate.

The variation of force exerted on the squash ball with time is shown on the graph.

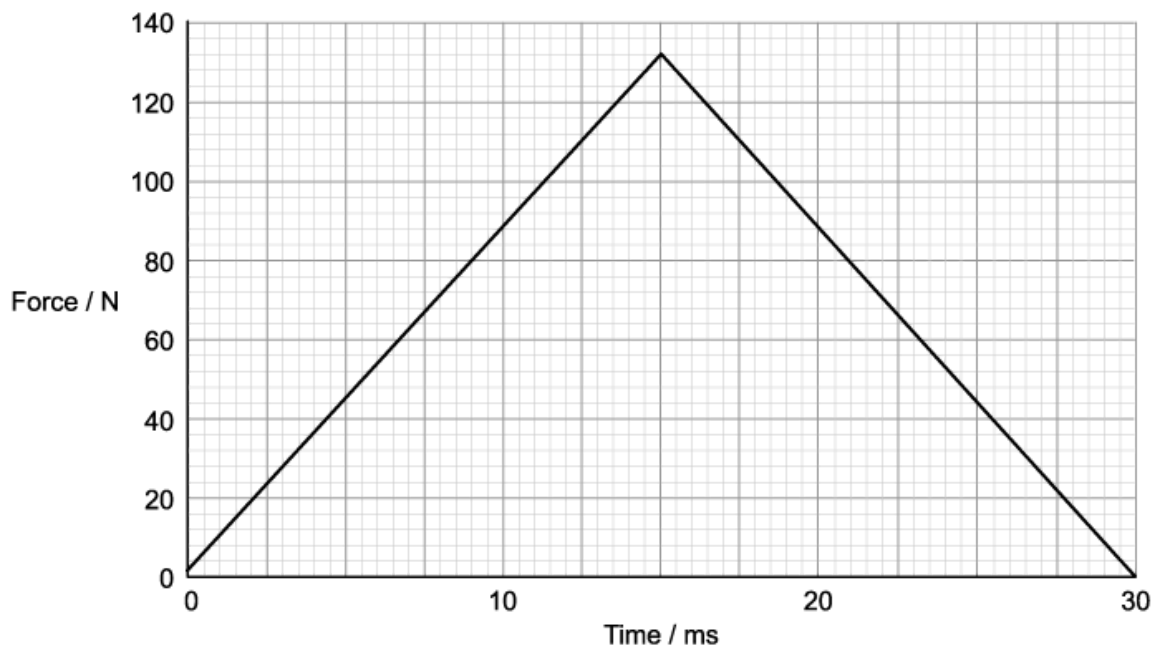

The ball strikes the plate with a speed of  $19.16 \text{ m s}^{-1}$  and has a mass of 60 g. It leaves the plate with a speed of  $13.83 \text{ m s}^{-1}$ .

Show that this is consistent with the impulse obtained from the graph.

.....

.....

.....

**(3 marks)**

- (b) Considering the first 30 ms of the ball's motion:

(i) Sketch a graph to show how the momentum of the ball varies.

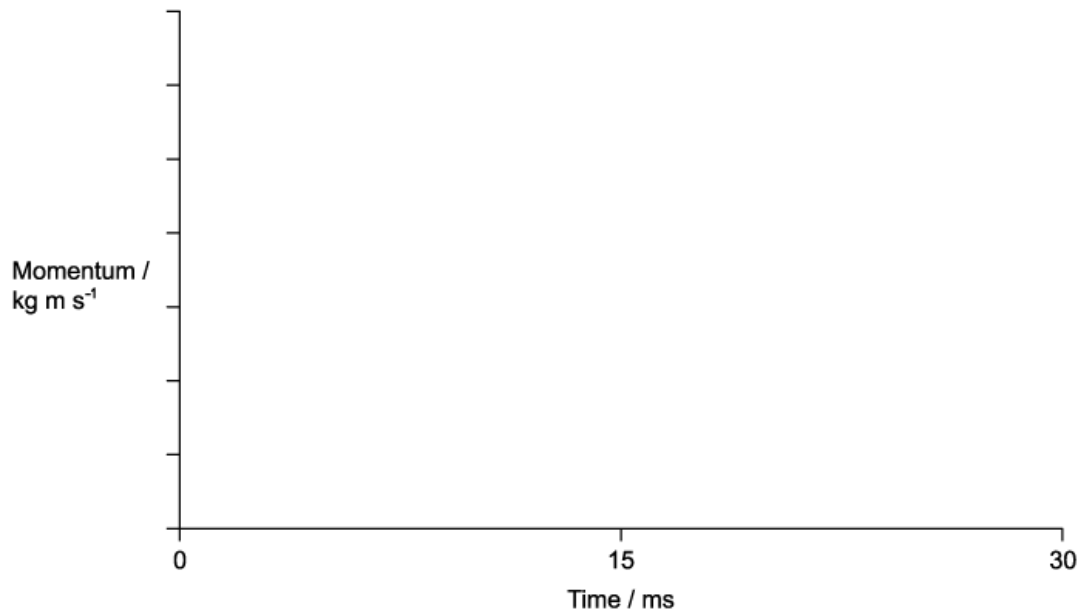

(ii) Explain how the ball's momentum varies in the first 30 ms of the motion. [1]

[5]

.....

.....

.....

.....

.....

.....

**(6 marks)**

(c) The ball continues to bounce, each time losing the same fraction of its energy when it strikes the plate. Air resistance is negligible.

Determine the percentage of the original gravitational potential energy of the ball that remains when it reaches its maximum height after bouncing five times.

.....

.....  
.....  
**(3 marks)**

- (d)** Explain, with reference to the conservation of momentum, the effect that the motion of the squash ball has on the motion of the Earth from the instant it is released until it bounces off the plate.

.....  
.....  
.....  
**(3 marks)**

8 (a) A stationary uranium nucleus decays by emitting an  $\alpha$  particle and thorium nucleus.

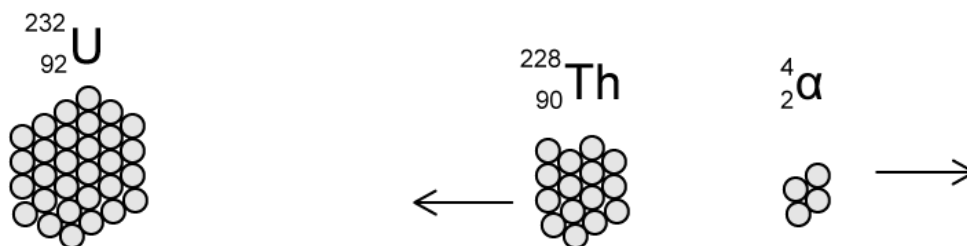

Discuss how the principle of conservation of momentum applies in this explosion.

.....

.....

.....

**(3 marks)**

(b) Assume that all of the energy released in the emission process is transferred as kinetic energy to the  $\alpha$  particle and the recoiling nucleus and is equal to 6.46 MeV.

Calculate the kinetic energy of the Thorium nucleus and  $\alpha$  particle in MeV.

.....

.....

.....

**(4 marks)**

(c) Show that momentum is conserved in this decay.

.....

.....

.....

**(3 marks)**

- (d) Collisions can occur between neutrons and stationary Uranium nuclei, for example, during nuclear fission.

Discuss how this collision would be if this was inelastic as opposed to elastic.

---

---

---

---

**(4 marks)**

- 9 (a)** Hemp ropes were the first to be used for ships' rigging to adjust the position of the sails and support the masts. Hemp is one of the strongest natural fibres available, has a very high tensile strength and is extremely rigid.

Today rock climbers use nylon ropes which are attached to their harness to break their fall. Nylon stretches considerably under tension.

Discuss in terms of impulse and momentum, why nylon ropes are favoured by rock climbers compared to hemp ropes.

---

---

---

---

**(4 marks)**

- (b)** A rock climber of mass  $m$  slips just after they attach a bolt to a piece of rock as they are climbing.

The length of the rope between their harness and the bolt on the rock face is  $h$ . Once the rope is fully extended their speed just before they come to a stop is  $v$ .

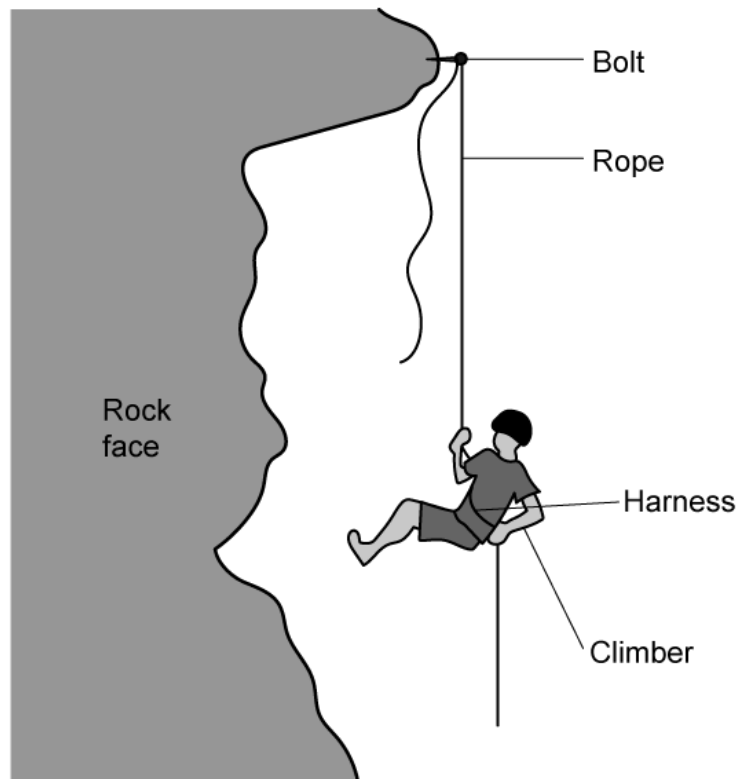

Show that the magnitude of the average decelerating force  $F$  on the climber when they are brought to rest is equal to their weight.

---

---

---

**(3 marks)**

**(c)** Deduce, without calculation, whether the average decelerating force  $F$  would still be equal to the climber's weight if they fell from higher up.

---

---

**(2 marks)**

**10 (a)** The speed of a dart pellet of mass 2.73 g is measured by firing it into a polystyrene block of mass 543 g suspended from a rigid support. The pellet becomes completely embedded in the polystyrene block. The block can swing freely at the end of a light inextensible string of length 1.5 m measured from the pivot to the centre of the block.

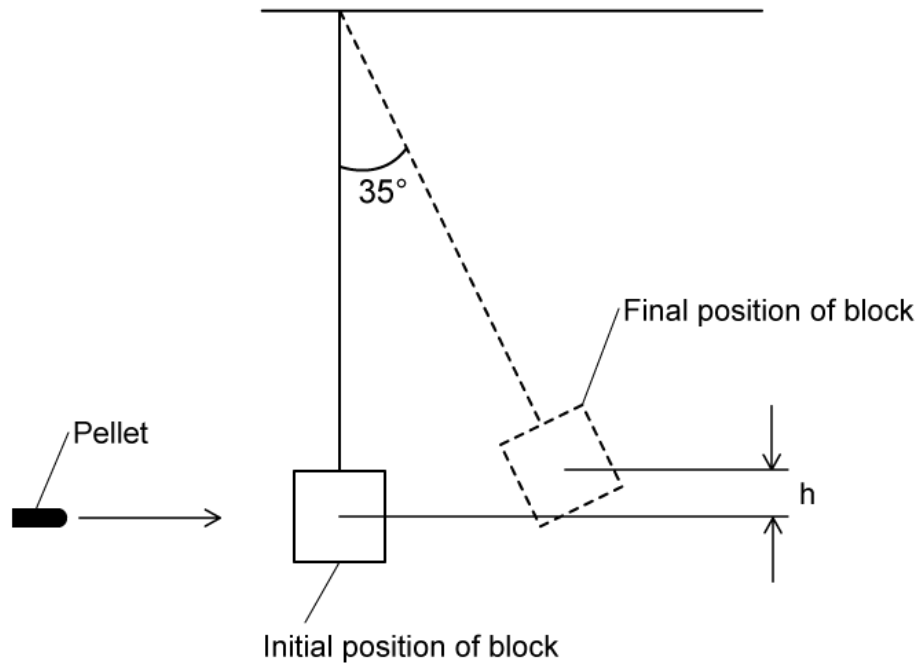

The centre of mass of the block rises by  $h$  at an angle of  $35^\circ$  to the vertical.

Determine the speed of the pellet when it strikes the polystyrene block.

.....

.....

.....

.....

.....

**(5 marks)**



- (b) The polystyrene block is replaced by a wooden block of the same mass. The experiment is repeated with the wooden block and an identical pellet. The pellet rebounds after striking the block.

A student makes an assumption that the angle that the wooden block makes with the vertical will be greater than  $35^\circ$  because the block doesn't have the additional mass of the pellet embedded within it.

Discuss the validity of the student's assumptions.

---

---

---

---

---

**(5 marks)**

- (c) A popular demonstration of the conservation of momentum and conservation of energy is Newton's cradle. It features several identical polished steel balls hung in a straight line in contact with each other.

If one ball is pulled back and allowed to strike the line, one ball is released from the other end whilst the rest are stationary. If two are pulled out, two are released on the other end and so forth.

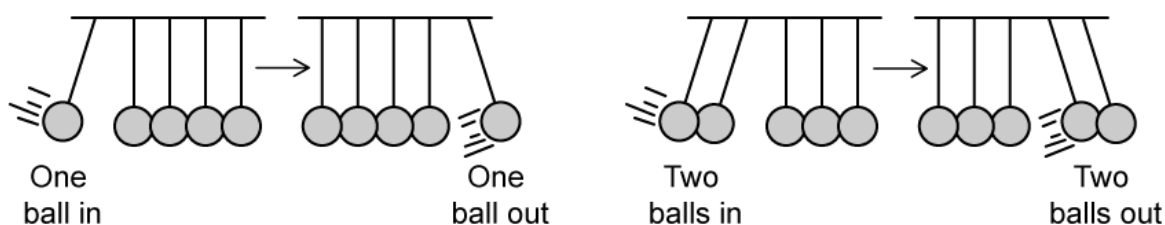

Assuming that Newton's Cradle is in a vacuum and considering energy and momentum conservation, explain why swinging one ball from the left will not release two balls on the right.

---

---

---

---

---

**(5 marks)**

- 11 (a)** A proton of mass  $m$  moves with uniform circular motion. Its kinetic energy is  $K$  and its orbital period is  $T$ .

Show that the orbital radius  $r$  is given by:

$$r = \sqrt{\frac{KT^2}{2\pi^2 m}}$$

.....  
.....  
**(2 marks)**

- (b)** The proton moves in a clockwise circle of circumference 1.25 mm. The net force on the proton is 65 fN.

Determine the linear speed of the proton.

.....  
.....  
.....  
**(3 marks)**

- (c)** Calculate the proton's orbital frequency.

.....  
.....  
.....  
**(3 marks)**

- (d)** (i) State the mechanism by which protons are made to travel in circular paths. [1]
- (ii) Comment on the work done on the proton by this mechanism. [2]

.....

---

---

**(3 marks)**

- 12 (a) A small ball is attached to a string and moves in a horizontal circular path. It completes one revolution every 2.5 s, with the string at an angle  $\theta$  to the vertical.

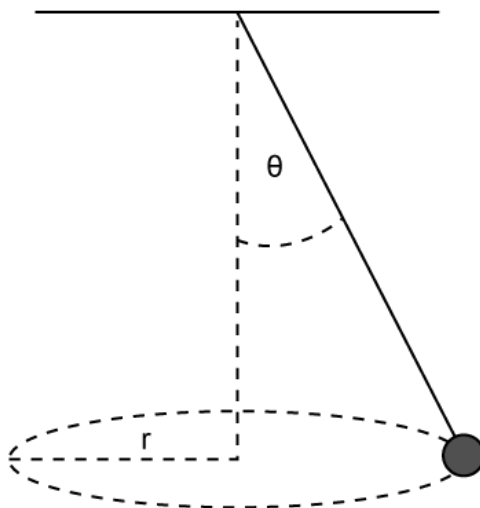

Calculate the orbital radius  $r$  if  $\theta = 12^\circ$ .

You may wish to use the following data:

$$\tan \theta = \frac{\sin \theta}{\cos \theta}$$

---

---

---

**(3 marks)**

- (b) Show that the length of the string  $l$  is given by:

$$l = \frac{g}{\omega^2 \cos \theta}$$

You may wish to use the following data:

$$\tan \theta = \frac{\sin \theta}{\cos \theta}$$

---

---

**(2 marks)**

- (c)** The equation in part (b) seems to suggest that the length of the string  $l$  is dependent on the angle it makes to the vertical,  $\theta$ .

Comment on the relationship between the length of the string  $l$  and the angle it makes to the vertical,  $\theta$ .

---

---

**(2 marks)**

13 (a) A marble rolls from the top of a bowling ball of radius  $R$ .

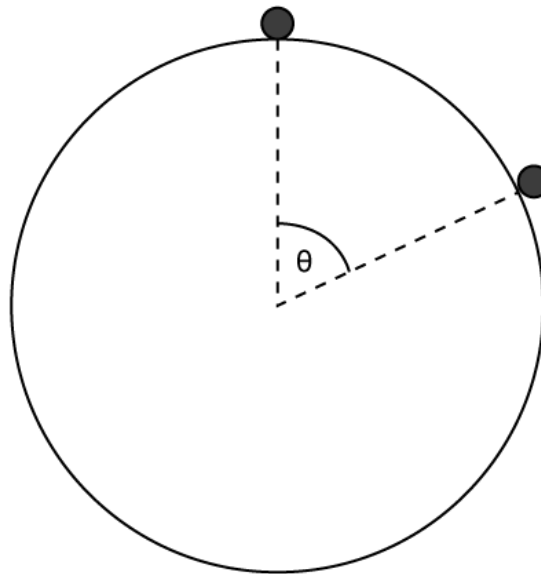

Show that when the marble has moved so that the line joining it to the centre of the sphere subtends an angle of  $\theta$  to the vertical, its speed  $v$  is given by:

$$v = \sqrt{2gR(1 - \cos \theta)}$$

---

---

---

(3 marks)

(b) Deduce that, at the instant shown in the image in part (a), the normal reaction force  $N$  on the marble from the bowling ball is given by:

$$N = mg(3 \cos \theta - 2)$$

---

---

---

---

**(4 marks)**

**(c)** Hence, determine the angle  $\theta$  at which the marble loses contact with the bowling ball.

---

---

**(2 marks)**



14 (a) The 'loop-the-loop' is a popular ride at amusement parks, involving passengers in cars travelling in a vertical circle.

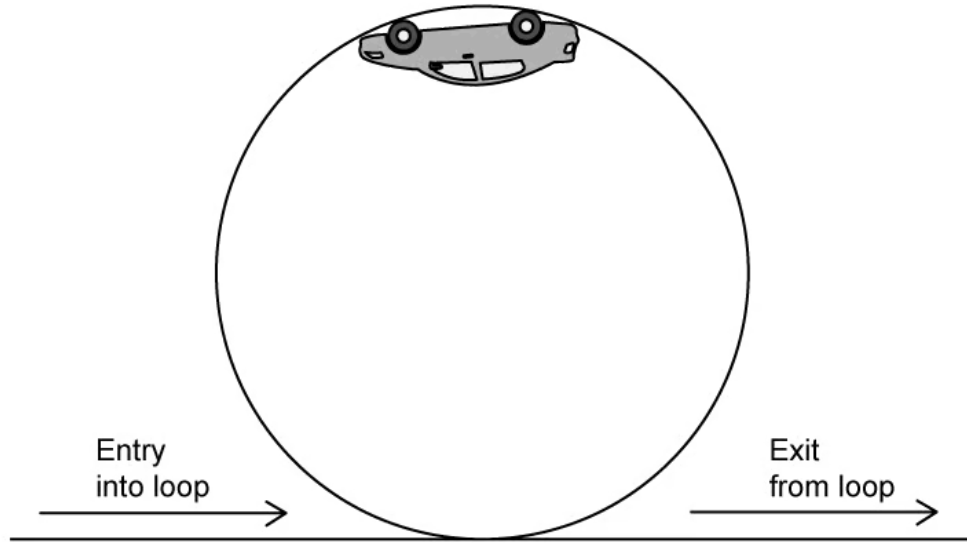

The loop has a radius of 8.0 m and a passenger of mass 70 kg travels at  $10 \text{ m s}^{-1}$  when at the highest point of the loop.

Calculate, at the highest point:

- (i) the centripetal acceleration of the passenger, [1]
- (ii) the force that the seat exerts on the passenger. [2]

.....

.....

.....

**(3 marks)**

(b) Stating any assumptions required, calculate the speed of the passenger at the point marked 'exit from loop' in part (a).

.....

.....

---

**(3 marks)**

- (c)** Operators must ensure that the speed of the vehicle carrying passengers into the loop-the-loop is above a certain value.

Suggest a reason for this, and determine the minimum required speed.

---

---

**(2 marks)**

- 15** A popular trick to impress young observers is to swing a bucket of water in a vertical circle. If the bucket is swung fast enough, no water spills out.

Estimate the minimum linear speed  $v$  required to swing a bucket in a vertical circle, such that no water spills.

---

---

**(3 marks)**