

HL IB Physics



Your notes

Forces & Momentum

Contents

- * Free-Body Diagrams
- * Newton's First Law
- * Newton's Second Law
- * Newton's Third Law
- * Contact Forces
- * Non-Contact Forces
- * Frictional Forces
- * Hooke's Law
- * Stoke's Law
- * Buoyancy
- * Conservation of Linear Momentum
- * Impulse & Momentum
- * Force & Momentum
- * Collisions & Explosions in One-Dimension
- * Collisions & Explosions in Two-Dimensions (HL)
- * Angular Velocity
- * Centripetal Force
- * Centripetal Acceleration
- * Non-Uniform Circular Motion



Your notes

Free-Body Diagrams

Free-Body Diagrams

- Forces are pushes or pulls that occur due to the interaction between objects
- In physics, during force interactions, it is common to represent situations as simply as possible without losing information
 - When considering force interactions, objects are represented as **point** particles
 - These point particles should be placed at the **centre of mass** of the object
- Forces are represented by **arrows** because forces are vectors
 - The length of the arrow gives the **magnitude** of the force, and its **direction** gives the force's direction
- The below example shows the forces acting on an object when pushed to the right over a rough surface

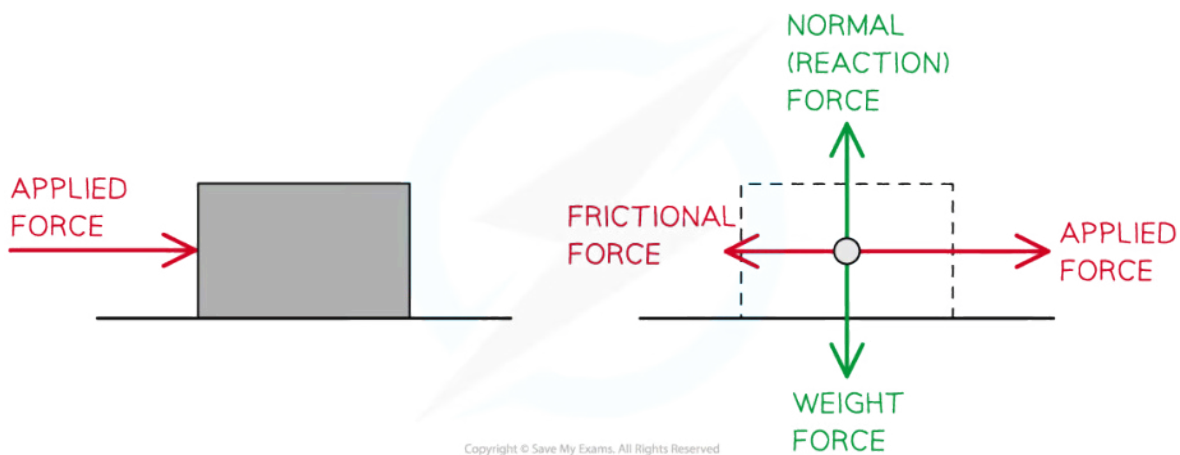

Point particle representation of the forces acting on a moving object

- The below example shows the forces acting on an object suspended from a stationary rope

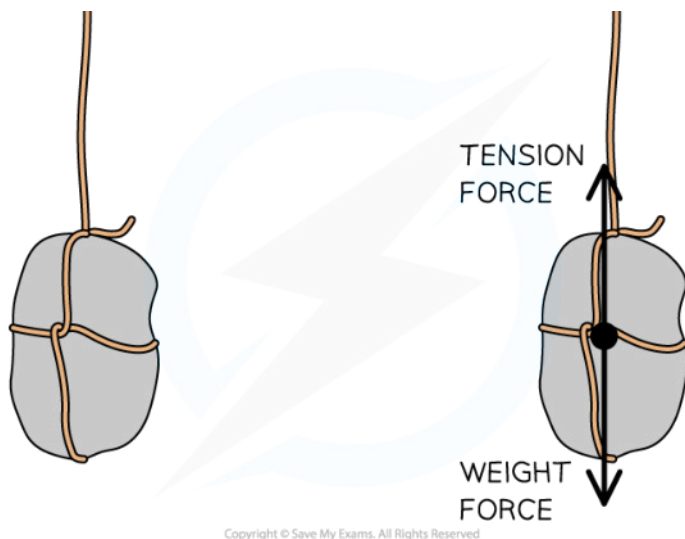

Copyright © Save My Exams. All Rights Reserved

Forces on an object suspended from a stationary rope

Free-body Diagrams

- As situations become more complex, there are often multiple forces acting in different directions on multiple objects
- To simplify these situations, **free-body force diagrams** can be used
- Free-body force diagrams show:
 - **Multiple forces** acting on **one object**
 - The **direction** of the forces
 - The **magnitude** of the forces
- Each force is represented as a **vector** arrow
 - The length of the arrow represents the **magnitude** of the force
 - The direction of the arrow shows the **direction** in which the force acts
- Each force arrow is **labelled** with either:
 - a description of the type of force acting and the objects interacting with clear cause and effect
 - The gravitational pull of the Earth on the ball
 - the name of the force
 - Weight
 - an appropriate symbol
 - F_g
- Free body diagrams can be used to:
 - identify which forces act in which plane
 - determine the resultant force
- The rules for drawing a free-body diagram are:
 - **Multiple forces** acting on **one object**
 - The object is represented as a **point mass**
 - Only the forces acting **on the object** are included
 - The forces are drawn in the correct **direction**

- The forces are drawn with **proportional magnitudes**
- The forces are clearly labelled

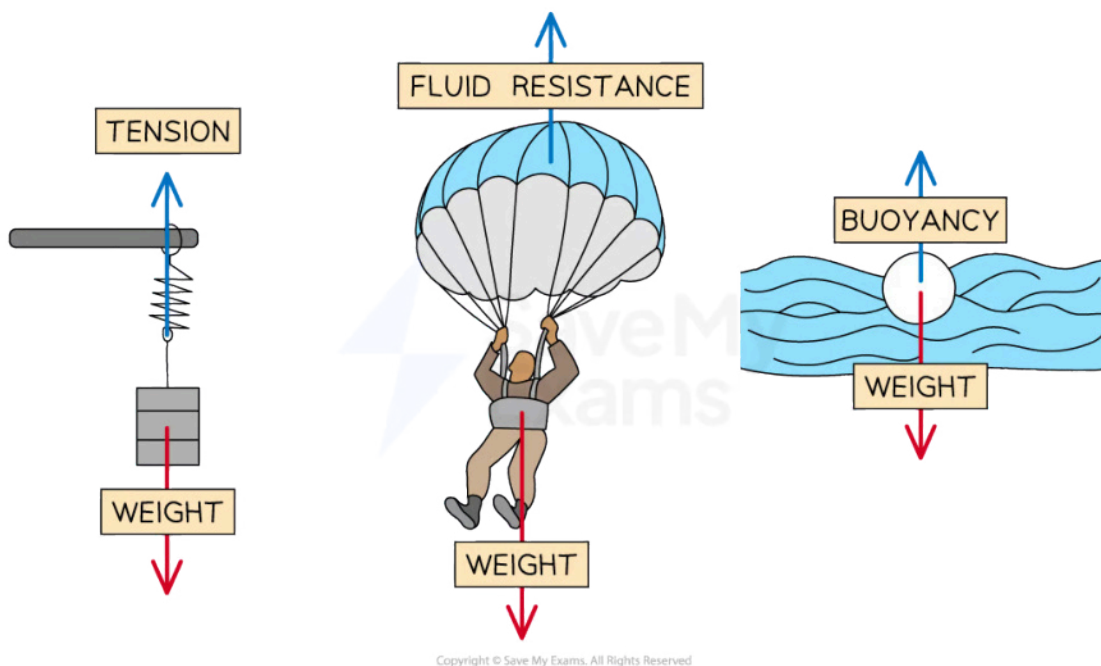

Copyright © Save My Exams. All Rights Reserved

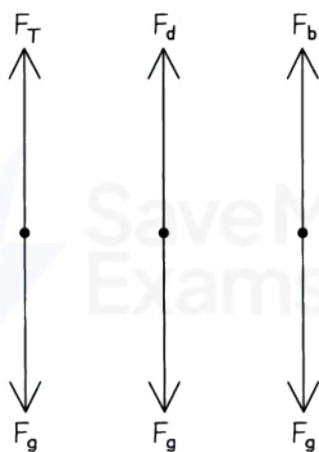

Copyright © Save My Exams. All Rights Reserved

Free-body diagrams for different situations

- The most common forces to apply are:
 - Weight (F_g) - always **towards** the **surface** of the planet
 - Tension (F_T) - always **away** from the mass
 - Normal Reaction Force (F_N) - **perpendicular** to a surface
 - Frictional Forces (F_f) - in the **opposite** direction to the motion of the mass



Your notes

Worked example

Draw free-body diagrams for the following scenarios:

- (a) A picture frame hanging from a nail.
- (b) A box sliding down a slope.

Answer:

(a) A picture frame hanging from a nail:

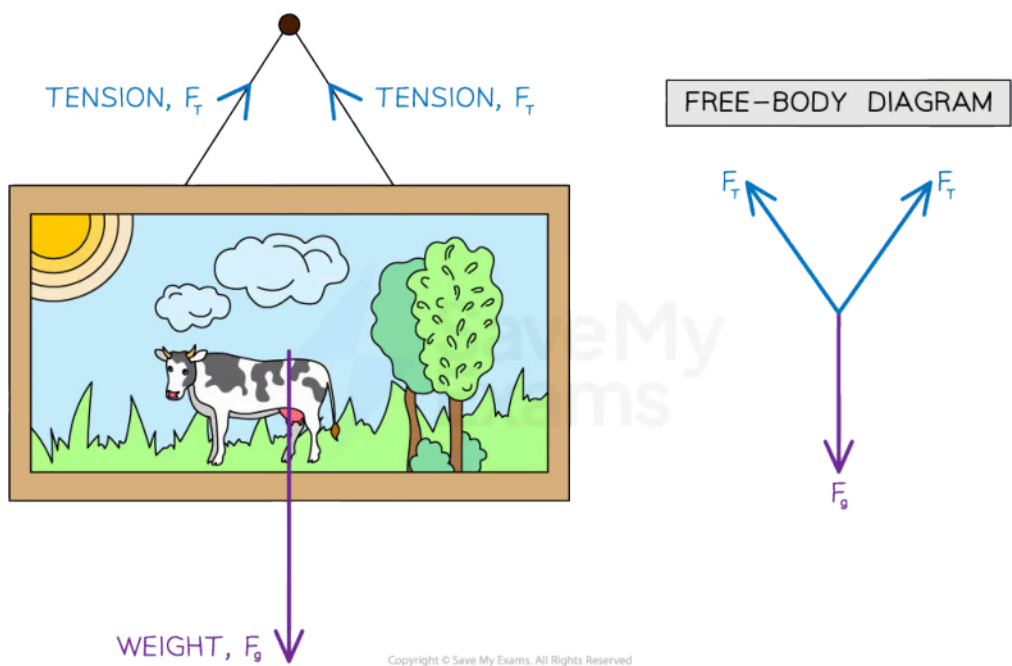

- The size of the arrows should be such that the 3 forces would make a closed triangle as they are **balanced**

(b) A box sliding down a slope:

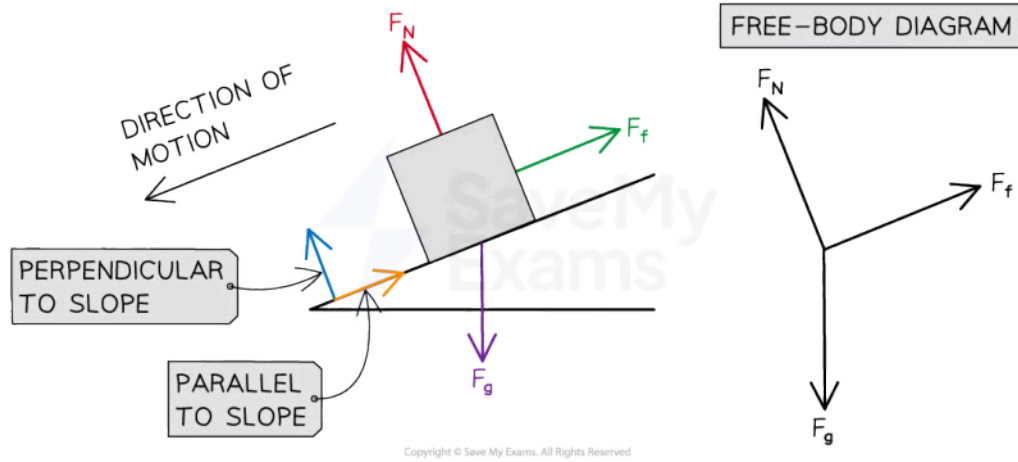

Your notes

- There are three forces acting on the box:
 - The **normal contact force**, F_N , acts perpendicular to the slope
 - **Friction**, F_f , acts parallel to the slope and in the opposite direction to the direction of motion
 - **Weight**, F_g , acts down towards the Earth



Your notes

Worked example

A toy sailboat has a weight of 30 N, and is floating in water. The boat is being pulled to the right with a force of 35 N. The boat has a total resistive force of 5 N.

Draw a free-body force diagram for the toy sailboat.

Answer:

Step 1: Identify all of the forces acting upon the object in question, including any forces that may be implied

- **Weight** = 30 N downward
- **Buoyancy** from the water (as the object is floating) = 30 N upward
- **Applied** force = 35 N to the right
- **Drag** force = 5 N to the left

Step 2: Draw in all of the force vectors (arrows), making sure the arrows start at the object and are directed away

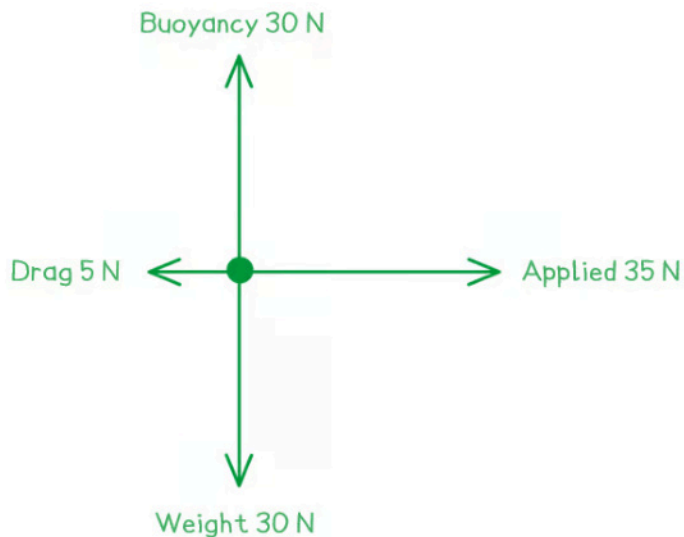

Examiner Tip

When labelling force vectors, it is important to use **conventional** and **appropriate** naming or symbols such as:

- F_g or Weight or mg
- F_N for normal reaction force

Using unexpected notation will **lose** you marks.

Make sure your arrows are roughly to scale with respect to the other forces in the image. In the second worked example, the 5 N force arrow needs to be considerably shorter than the 35 N arrow. This shows clearly that there is a resultant force to the right.



Your notes



Your notes

Determining Resultant Forces

- Free-body diagrams can be analysed to find the **resultant force** acting within a system
- A **resultant force** is the **vector sum** of the forces operating on a body
 - When many forces are applied to an object they can be **combined**
 - This produces **one** overall force, which describes the **combined action** of all of the forces
- This single resultant force determines the change in the object's motion:
 - The **direction** in which the object will move as a result of all of the forces
 - The **magnitude** of the total force experienced by the object
- The resultant force is sometimes called the **net force**
- Forces can combine to produce
 - Balanced** forces
 - Unbalanced** forces
- Balanced** forces mean that the forces have combined in such a way that they cancel each other out
- Then, the resultant force acting on the body is **zero**
 - For example, the **weight** force of a book on a desk is balanced by the **normal contact** force of the desk
 - As a result, **no resultant force** is experienced by the book; the forces acting on the book and the table are **equal** and **balanced**

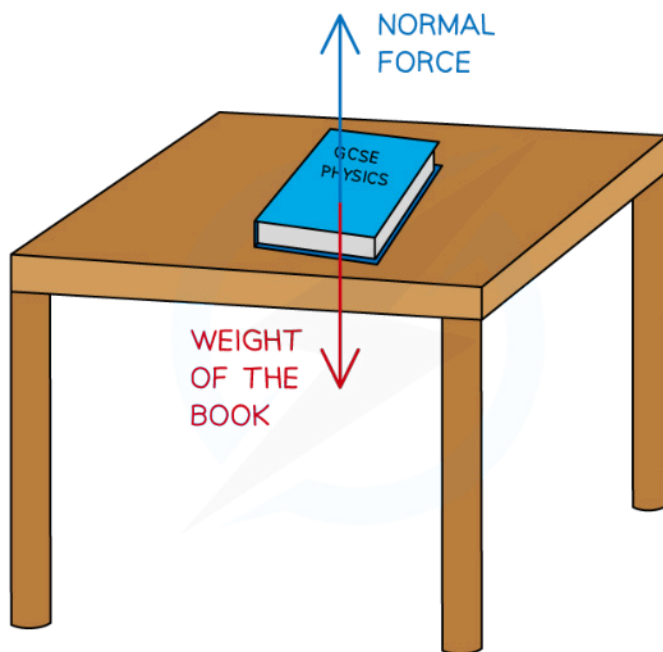

Copyright © Save My Exams. All Rights Reserved

A book resting on a table is an example of balanced forces

- Unbalanced** forces mean that the forces have combined in such a way that they do not cancel out completely and there is a **non-zero resultant force** on the object



Your notes

- For example, two people play a game of tug-of-war, working against each other on opposite sides of the rope
- If Person **A** pulls on the rope with a force 80 N to the left and Person **B** pulls on the rope with a force of 100 N to the right, these forces **do not cancel** each other out completely
- Since Person **B** pulled with more force than Person **A**, the forces will be **unbalanced**, and the rope will experience a **resultant force** of 20 N to the **right**

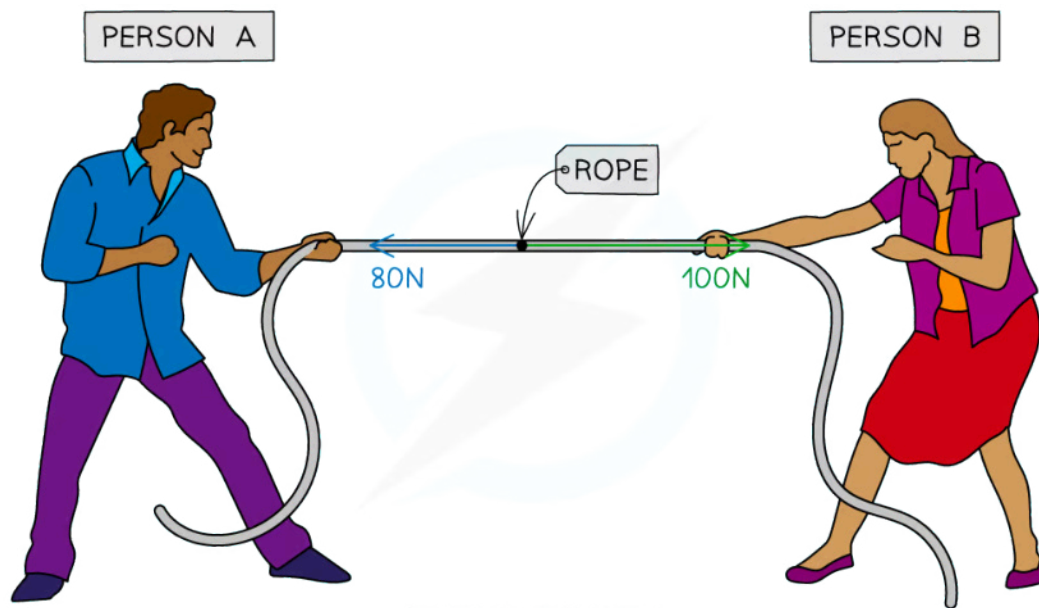

Copyright © Save My Exams. All Rights Reserved

A tug-of-war is an example of when forces can become unbalanced

Resultant forces in one-dimension

- The resultant force in a one-dimensional situation i.e. when the forces are directed along the **same** plane, can be found by **combining vectors**
- Combining force vectors involves **adding** all of the forces acting on the object taking into account the direction of the forces
- This is easiest to visualise when they are drawn as a **free-body diagram**
- If the forces acting in opposite directions are equal in size, then there will be no resultant force
- The forces are said to be **balanced**



Your notes

+ DIRECTION TO THE RIGHT \longrightarrow

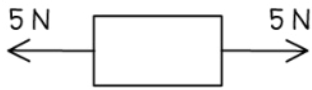

$F = (-5) + 5 = 0 \text{ N}$
(THE FORCES ARE BALANCED)

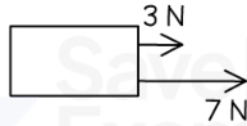

$F = 3 + 7 = 10 \text{ N}$
(RESULTANT FORCE TO THE RIGHT)

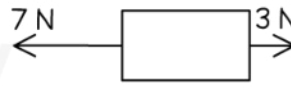

$F = (-7) + 3 = -4 \text{ N}$
(RESULTANT FORCE TO THE LEFT)

Copyright © Save My Exams. All Rights Reserved

Diagram showing the resultant forces on three different objects

- Imagine the forces on the boxes as **two people** pushing and pulling on either side
 - In the first scenario, the two people are evenly matched - the box **doesn't move**
 - In the second scenario, the two people are pushing on the same side of the box, it moves to the **right** with their combined strength
 - In the third scenario, the two people are pushing against each other and are not evenly matched, so there is a **resultant force to the left**

Resultant forces in two-dimensions

- The resultant force in a two-dimensional situation i.e. when the forces are **not** on the same plane, can be found from **resolving vectors**
- Resolving force vectors involves using **Pythagoras** or **trigonometry** to determine the resultant of all of the forces acting on the object

SITUATION

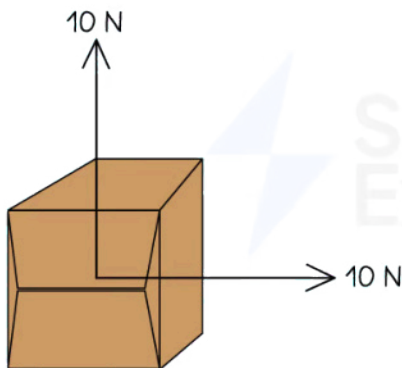

FREE-BODY DIAGRAM

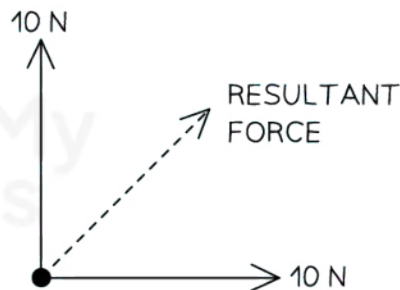

Copyright © Save My Exams. All Rights Reserved

The resultant force is easier to visualise using a free-body diagram



Your notes

- For example, the two 10 N forces acting on the cardboard box produce a resultant force of
 - $F = \sqrt{10^2 + 10^2} = 14 \text{ N}$
- More on these calculations can be found in [Combining & Resolving Vectors](#)

Worked example

Calculate the magnitude and direction of the resultant force on the object shown in the diagram below.

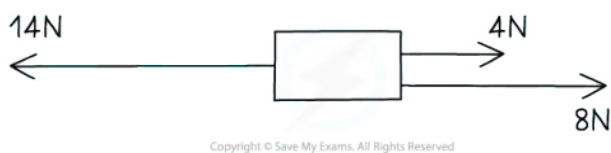

Answer:

Step 1: Decide on the direction you will define as positive and negative

- Take the right as **positive** and the left as **negative**

Step 2: Add up all of the forces

$$F = (-14) + 4 + 8 = -2 \text{ N}$$

Step 4: Evaluate the direction of the resultant force

- Since the resultant force is negative, this is in the negative direction i.e. the **left**

Step 5: State the magnitude and direction of the resultant force

- The resultant force is **2 N to the left**



Your notes

 **Worked example**

Calculate the magnitude and direction of the resultant force acting on the cardboard box shown in the diagram below.

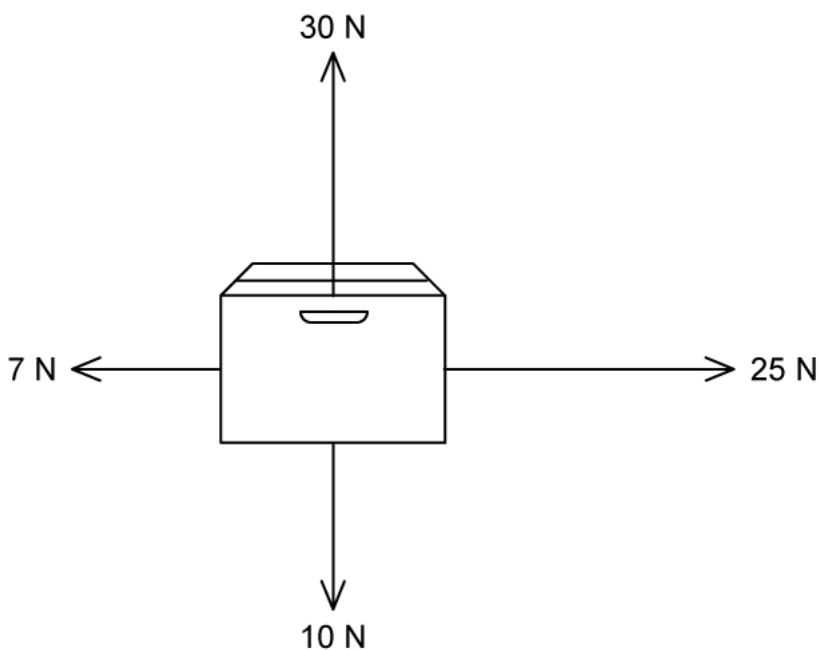

Answer:

Step 1: Sketch the free-body diagram for the situation

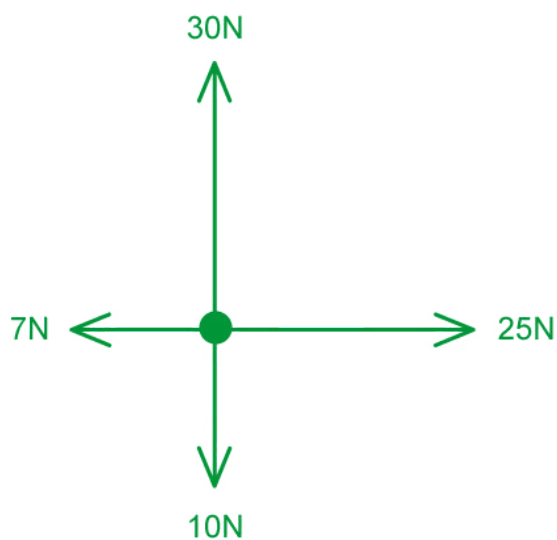



Your notes

Step 2: Determine the resultant horizontal force

- Taking the right as positive

$$F_h = (-7) + 25 = 18 \text{ N (to the right)}$$

Step 3: Determine the resultant vertical force

- Take upwards as positive

$$F_v = 30 + (-10) = 20 \text{ N (upwards)}$$

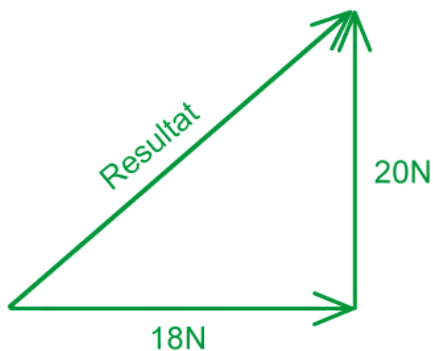
Step 4: Calculate the resultant force

- Using Pythagoras' theorem

$$F = \sqrt{18^2 + 20^2} = 27 \text{ N}$$

 **Examiner Tip**

Take a look at the 'Tools' section of the course to learn how to combine and resolve vectors. You should be comfortable with these calculations for the whole of the forces topic.



Your notes

Newton's First Law

Newton's First Law

- Newton's laws of motion describe the relationship between the forces acting on objects and the motion of the objects
- Newton's first law of motion states:
A body will remain at rest or move with constant velocity unless acted on by a resultant force
- This means that:
 - An object at rest will remain at rest unless acted upon by a resultant force
 - An object moving with a constant velocity will remain moving at that constant velocity unless acted upon by a resultant force
- A **resultant force** is required to **change** the **motion** of an object
 - To speed up
 - To slow down
 - To change direction
- If the resultant force acting on an object is **zero**, it is said to be in **translational equilibrium**
- If the resultant force is zero (the forces on a body are balanced), the body must be either:
 - At **rest**
 - Moving at a **constant velocity**



Your notes

AT REST



AT CONSTANT VELOCITY



BALANCED FORCES =
RESULTANT FORCE IS 0

Copyright © Save My Exams. All Rights Reserved

For both cases of the football being at rest or moving at a constant velocity, its resultant force is 0

- Since force is a vector, it is easier to split the forces into **horizontal** and **vertical** components
- If the forces are **balanced**:
 - The forces acting to the **left** = the forces acting to the **right**
 - The forces acting **upward** = the forces acting **downward**
- The **resultant force** is the vector sum of **all** the forces acting on the body



Your notes

Worked example

If there are no external forces acting on the car other than friction, and it is moving at a constant velocity, what is the value of the frictional force F_f ?

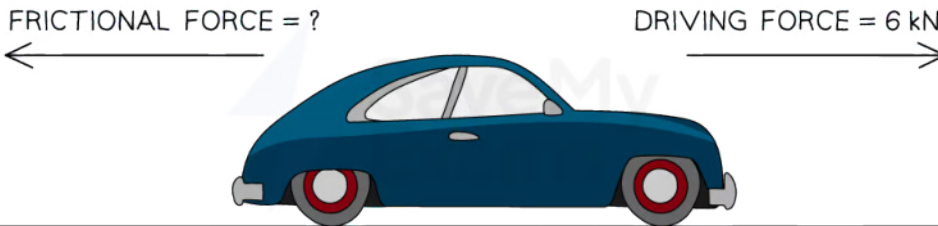

Answer:

- Since the car is moving at a constant velocity, there is no resultant force. This means that the driving force and the frictional forces are balanced.
- Therefore, $F_f = 6 \text{ kN}$

Examiner Tip

This law may sound counter-intuitive for an object that is moving at constant velocity. How can it be moving if the forces on it are balanced?

This is because a resultant force causes an **acceleration**. An object moving at constant velocity has no acceleration, so its forces must be balanced, which means the resultant force is zero. The drag forces are invisible to us, which makes this tricky to see.



Your notes

Newton's Second Law

Newton's Second Law

- Newton's second law describes the change in motion that arises from a resultant force acting on an object
- Newton's second law of motion states:
The resultant force on an object is directly proportional to its acceleration

- This can also be written as:

$$F = ma$$

- Where:
 - F = resultant force (N)
 - m = mass (kg)
 - a = acceleration (m s^{-2})
- This relationship means that objects will **accelerate** if there is a **resultant force** acting upon them
- The **acceleration** will always act in the **same direction** as the resultant force
- When **unbalanced forces** act on an object, the object experiences a **resultant force**
- If the resultant force acts **along** the **direction** of the object's **motion**, the object will:
 - Speed up (accelerate)
 - Slow down (decelerate)
- If the resultant force acts on an object at an **angle to** its **direction of motion**, it will:
 - Change direction

Resultant Force

- Force** is a **vector** quantity with both **magnitude** and **direction**
- The resultant force is, therefore, the **vector sum** of all the forces acting on the body
- If the object is in motion, then the positive direction is in the direction of motion



Your notes

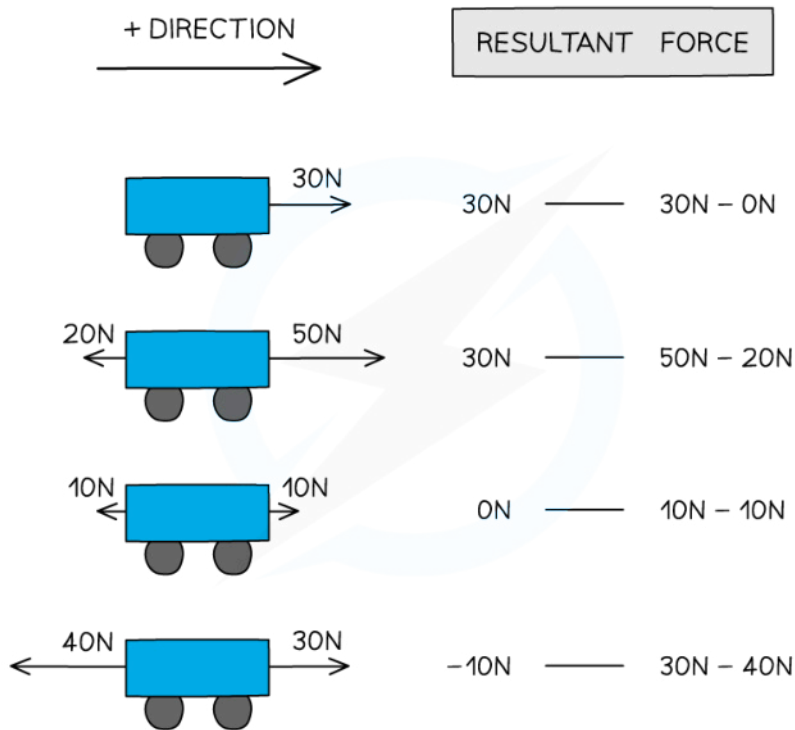

Copyright © Save My Exams. All Rights Reserved

Resultant forces on a body can be positive or negative depending on their direction

- If the resultant force acts at an angle to the direction of motion, the magnitude and direction of the resultant force can be found by
 - Combining vectors
 - Scale drawings
 - This is covered further in [Scale Diagrams](#)

Acceleration

- **Acceleration** is a **vector** quantity with both **magnitude** and **direction**
- If the resultant force acts in the direction of an object's motion, the acceleration is **positive**
- If the resultant force opposes the direction of the object's motion, the acceleration is **negative**
- But the **acceleration** will always act in the **same direction** as the **resultant force**

 **Examiner Tip**

It is important to understand that for an object in motion, a resultant force that opposes that motion will cause the object to decelerate, not to suddenly travel backwards.

If no drag forces are present, then the acceleration of a falling object is independent of its mass. This unintuitive fact of physics has been proven by astronauts on the Moon, who simultaneously dropped both a hammer and a feather from equal heights and found that they hit the ground at the same time! (Because there is no air resistance on the Moon.)



Your notes



Your notes

Worked example

A rocket produces an upward thrust of 15 MN and has a weight of 8 MN.

(a) When in flight, the force due to air resistance is 500 kN.
Determine the resultant force on the rocket.

(b) The mass of the rocket is 0.8×10^5 kg.

Calculate the magnitude and direction of the acceleration of the rocket.

Answer

Part a)

Step 1: Draw a force diagram of the situation

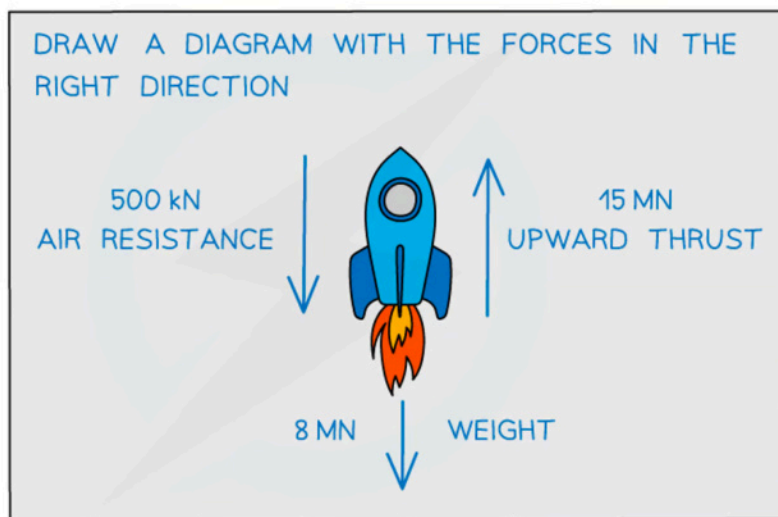

Step 2: Convert the forces into newtons and assign directions

- The direction of motion is upwards, therefore upwards is the positive direction
 - Air resistance (downward acting) = $-500 \text{ kN} = -500 \times 10^3 \text{ N}$
 - Weight (downward acting) = $-8 \text{ MN} = -8 \times 10^6 \text{ N}$
 - Thrust (upward acting) = $15 \text{ MN} = 15 \times 10^6 \text{ N}$

Step 3: Calculate the resultant force

$$F = (15 \times 10^6) + (-8 \times 10^6) + (-500 \times 10^3)$$

$$F = 6.5 \times 10^6 \text{ N} = 6.5 \text{ MN}$$

- The positive value indicates that the resultant force acts in the direction of motion i.e., upwards

Part b)

Step 1: State the equation for Newton's second law and rearrange to make acceleration the subject

$$F = ma \Rightarrow a = \frac{F}{m}$$

Step 2: Calculate the acceleration and state the direction

$$a = \frac{6.5 \times 10^6}{0.8 \times 10^5}$$

$$a = 81 \text{ m s}^{-2} \text{ (2 s.f.) upwards}$$

- Acceleration is in the same direction as the resultant force

Examiner Tip

Air resistance is a type of fluid resistance because fluids are gases or liquids. The IB specification uses fluid resistance so you should use this term when referring to air resistance in the exam. Air resistance and fluid resistance are drag forces since drag is the force exerted by the particles in a fluid on an object moving it. The symbol for fluid resistance is therefore the same as symbol for drag, F_d .



Your notes



Your notes

Worked example

Three forces, 4 N, 8 N, and 24 N act on an object with a mass of 5 kg. Which acceleration is **not** possible with any combination of these three forces?

- A. 1 m s^{-2}
- B. 4 m s^{-2}
- C. 7 m s^{-2}
- D. 10 m s^{-2}

Answer:

Step 1: List the values given

- Three possible forces at any angle of choice: 4 N, 8 N, and 24 N
- Mass of object = 5 kg

Step 2: Consider the relevant equation

- Newton's second law relates force and acceleration:

$$F = m \times a$$

Step 3: Rearrange to make acceleration the focus

$$a = \frac{F}{m}$$

Step 4: Investigate the minimum possible acceleration

- The minimum acceleration would occur when the forces were acting **against** each other
- This is when just the 4 N force is acting on the body
- Now check the acceleration:

$$a = \frac{4}{5} = 0.8 \text{ m s}^{-2}$$

Step 4: Investigate the maximum possible acceleration

- The maximum acceleration would occur when **all** three forces are acting in the same direction
- This is a total force of

$$a = 4 + 8 + 24 = 36 \text{ N}$$

- With acceleration:

$$a = \frac{36}{5} = 7.2 \text{ m s}^{-2}$$

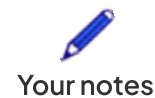

Step 5: Consider this range and the options

- Since option **D** is higher than 7.2 m s^{-2} ; it is not possible that these three forces can produce 10 m s^{-2} acceleration for this mass
- **Option D** is the **correct** answer, as it is the only one that is not possible

Examiner Tip

The direction you consider **positive** is **your choice**, as long as the signs of the numbers (positive or negative) are consistent throughout the question.

It is a general rule to consider the direction the object is initially travelling in as positive. Therefore all vectors in the direction of motion will be positive and opposing vectors, such as drag forces, will be negative.

Newton's Second Law and Momentum

- Newton's second law can also be given in terms of **momentum**

The resultant force on an object is equal to its rate of change of momentum

- This **change in momentum** is in the **same direction** as the resultant force
- These two definitions are derived from the definition of momentum, as follows:

- Momentum:

$$p = mv$$

- Rate of change of momentum:

$$\frac{\Delta p}{\Delta t} = m \frac{\Delta v}{\Delta t}$$

- Force:

$$F = m \frac{\Delta v}{\Delta t}$$

- Acceleration:

$$a = \frac{\Delta v}{\Delta t}$$

- Therefore:

$$F = ma$$



Your notes

Worked example

A girl is riding her skateboard down the road and increases her speed from 1 m s^{-1} to 4 m s^{-1} in 2.5 s .

The force driving her forward is 72 N .

Calculate the combined mass of the girl and the skateboard.

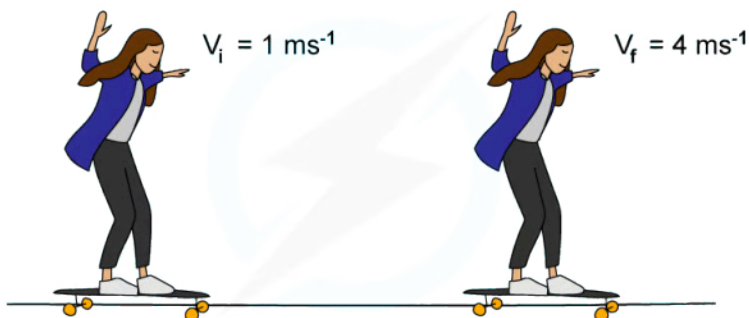

Copyright © Save My Exams. All Rights Reserved

STEP 1 NEWTON'S SECOND LAW STATES THE RESULTANT FORCE IS EQUAL TO THE RATE OF CHANGE IN MOMENTUM

$$F = \frac{\Delta p}{\Delta t}$$

STEP 2 FIND CHANGE IN MOMENTUM Δp

$\Delta p = \text{FINAL MOMENTUM} - \text{INITIAL MOMENTUM}$

$$\Delta p = mv_f - mv_i$$

STEP 3 SUBSTITUTE ALL VALUES INTO NEWTON'S SECOND LAW

$$72 \text{ N} = \frac{m(4 - 1)}{2.5}$$

MASS m IS CONSTANT SO CAN BE TAKEN OUT AS FACTOR

STEP 4 REARRANGE FOR MASS m

$$m = \frac{72 \times 2.5}{3} = 60 \text{ kg}$$

Copyright © Save My Exams. All Rights Reserved



Your notes

Newton's Third Law

Newton's Third Law

- Newton's first and second laws of motion deal with **multiple forces** acting on a **single object**
- Newton's third law deals with the forces involved when **two objects** interact
- Newton's Third Law states:

If Object A exerts a force on Object B, then Object B will exert a force on Object A which is equal in magnitude but opposite in direction

- When two objects interact, the forces involved arise in pairs
 - These are often referred to as **third-law pairs**
- A Newton's third law force pair must be:
 - The **same type** of force
 - The **same magnitude**
 - Opposite** in **direction**
 - Acting on **different objects**
- Newton's third law explains the forces that enable someone to walk
- The image below shows an example of a pair of equal and opposite forces acting on two objects (the ground and a foot):

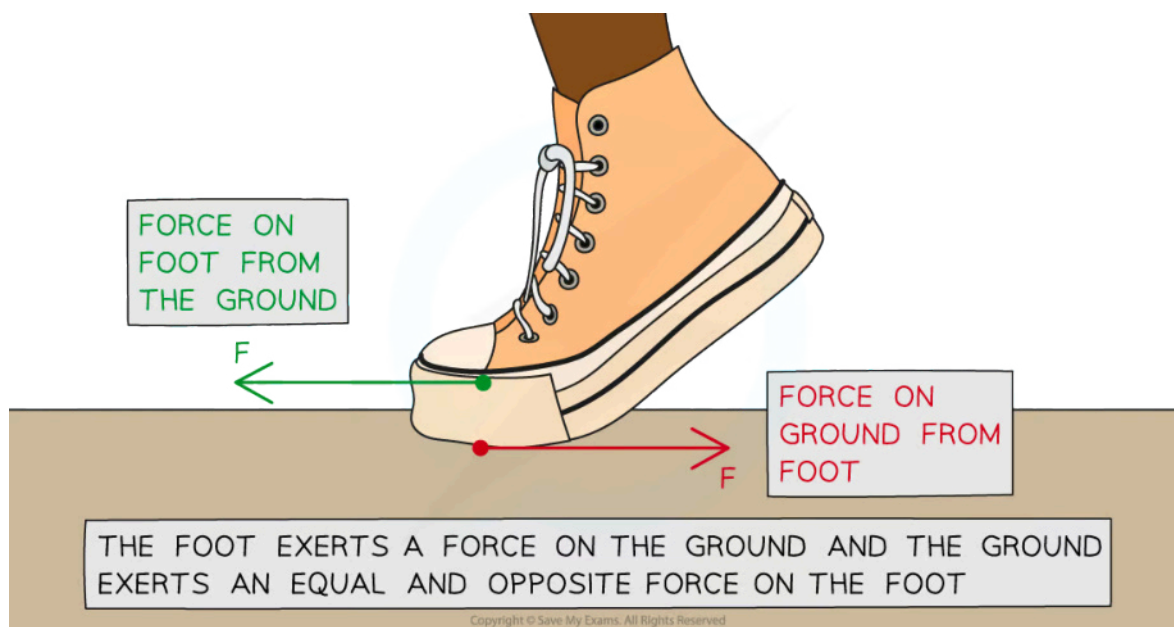

Newton's Third Law: The foot pushes the ground backwards, and the ground pushes the foot forwards

- The **foot** pushes on the **ground** and the **ground** pushes back on the **foot**

- Both of these forces are the **normal contact force** (sometimes called the support force or the normal reaction force)
- The forces are of **equal magnitude**
- The forces are **opposite in direction**
- The forces are acting on **different objects** (the foot and the ground)



Your notes

Examiner Tip

It is a common error to misidentify the forces acting in a third law situation. You may have identified the force acting on the ground as weight. The magnitude of the normal contact force of the foot acting on the ground is equal to the person's weight (assuming only one foot is on the ground) which is where the confusion arises.

Remember that for a third law pair of forces, they must be the same type of force. So if you are considering the weight of the person, you actually mean the gravitational pull of the Earth on the person. Therefore, the third law pair would be the gravitational pull of the person on the Earth.

It can be very helpful to simplify the language when you deal with third law pairs and just describe the force as a push or a pull to start with.

A good framework for this is a 3 part label: Object A pushes/pulls on Object B, and Object B pushes/pulls on Object A.

From here you can see if you are dealing with a third law pair and add in the extra detail from there.

Worked example

A physics textbook is at rest on a lab bench. Student A draws a free-body force diagram for the book and labels the forces acting on it.

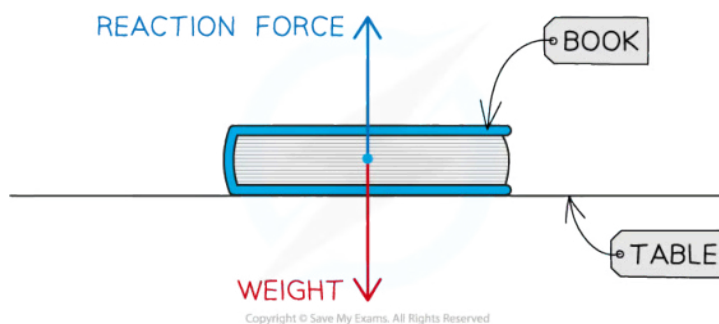

Student A says the diagram is an example of Newton's third law of motion. Student B disagrees and says the diagram is an example of Newton's first law of motion.

By referring to the free-body force diagram, state and explain who is correct.

Answer:

Step 1: State Newton's first law of motion

- Objects will remain at rest, or move with a constant velocity unless acted on by a resultant force

Step 2: State Newton's third law of motion

- If Object A exerts a force on Object B, then Object B will exert a force on Object A which is equal in magnitude but opposite in direction

Step 3: Check if the diagram satisfies the conditions for identifying Newton's third law

- A Newton's third law force pair must be:
 - The **same type** of force
 - The **same magnitude**
 - Opposite** in direction
 - Acting on **different objects**
- The forces acting on the book are **not the same type**
 - The forces acting on the book are **weight** and **normal contact force**
- The forces are **not acting on different objects**
 - Both forces are acting on the book
- Therefore, this is **not** an example of Newton's third law
 - This is an example of Newton's first law

Step 4: Conclude which person is correct

- **Student B** is correct

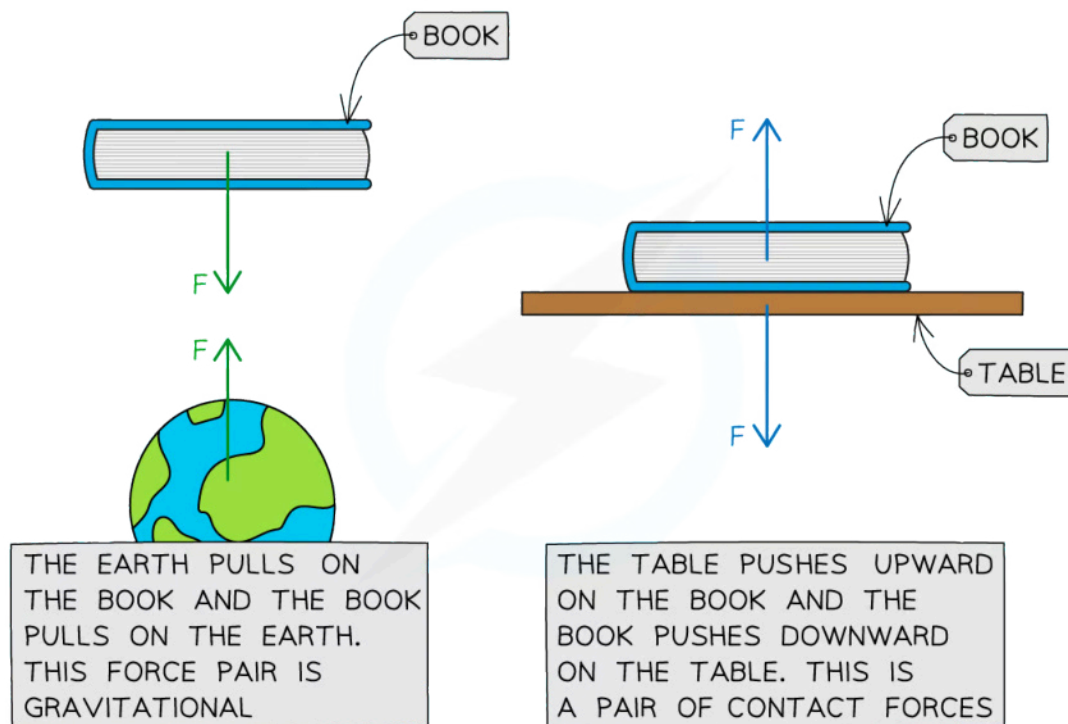

Copyright © Save My Exams. All Rights Reserved

- The clue is the **free-body force** diagram, these only apply to **multiple forces** acting on **one object**
- The forces acting on the book are of equal magnitude and in opposite direction so there is zero resultant force acting on the book and it remains at rest on the lab bench
- To apply **Newton's third law** to this situation, the interaction between **two objects** must be considered
 - The **book** pushes on the **table** and the **table** pushes back on the **book**
 - These are both **normal contact forces** of equal magnitude and opposite direction
 - The **book** pulls on the **Earth**, the **Earth** pulls on the **book**
 - These are both **weight** forces (the gravitational pull of the Earth on the book, and the gravitational pull of the book on the Earth) of equal magnitude and opposite direction

Examiner Tip

Just because you see two forces of equal magnitude acting in opposite directions doesn't mean they are a Newton's third law force pair! The confusion often arises in the book example because the normal contact force of the book on the table is equal in magnitude and direction to its weight.

You must remember to apply the specific criteria; a Newton's third law pair must meet **all** of the criteria.



Your notes

Contact Forces

Contact Forces

- A contact force is defined as:
A force which acts between objects that are physically touching

- Examples of contact forces include:
 - Friction
 - Fluid resistance or viscous drag
 - Tension
 - Normal (reaction) force

Surface friction, F_f

- Surface friction is a force that opposes **motion**
- Occurs when the surfaces of objects rub against each other, e.g. car wheels on the ground

Fluid resistance or viscous drag, F_d

- Fluid resistance, or viscous drag, is a type of **friction**
- Occurs when an object moves through a fluid (a liquid or a gas)
- Air resistance is a type of fluid resistance or viscous drag force

Tension, F_T

- Tension is a force that occurs within an object when a pulling force is applied to both ends
- Occurs when **two forces** are applied in opposite directions to the ends of an object e.g. a mass on a spring suspended from a clamp

Normal / reaction force, F_N

- Reaction forces occur when an object is supported by a surface
- It is the component of the contact force acting **perpendicular** to the surface that counteracts the body e.g. a book on a table



Your notes

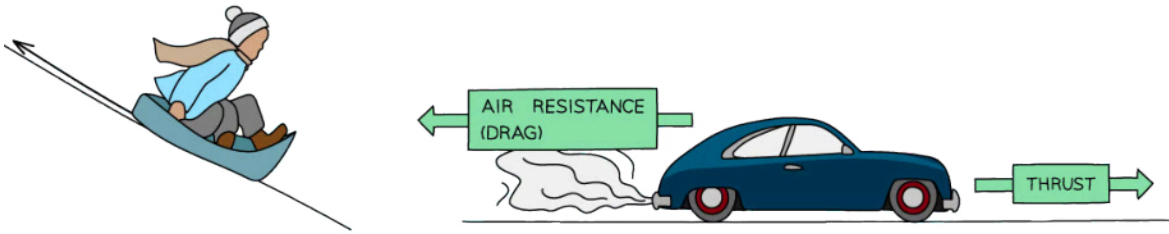

FRICION AND AIR RESISTANCE OPPOSE THE MOTION OF OBJECTS

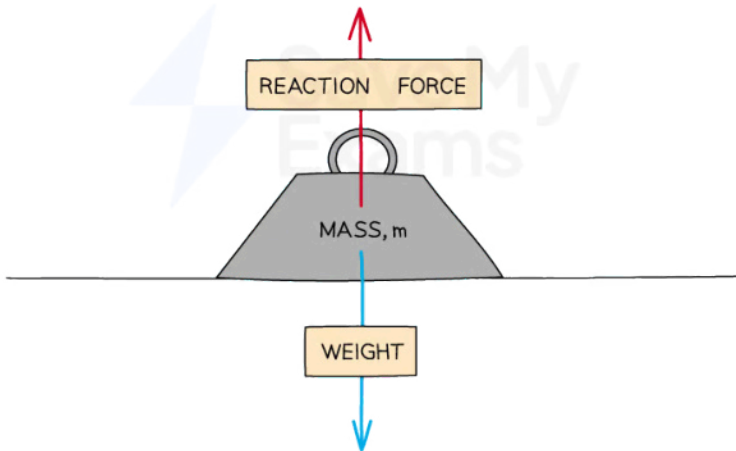

REACTION FORCES ACT BETWEEN TOUCHING OBJECTS AND, AS IN THE ABOVE EXAMPLE, CAN SUPPORT AN OBJECT BY BALANCING ITS WEIGHT

Copyright © Save My Exams. All Rights Reserved

Examples of contact forces



Your notes

Non-Contact Forces

Non-Contact Forces

Non-Contact Forces

- A non-contact force is defined as:

A force which acts at a distance, without any physical contact between bodies, due to the action of a field

- Examples of non-contact forces include:
 - Gravitational force
 - Electrostatic force
 - Magnetic force

Gravitational force, F_g

- The **attractive** force experienced by two objects with mass in a gravitational field e.g. the force between a planet and a comet
 - Weight**, on Earth, is the gravitational force of the Earth acting on an object with mass
 - $F_g = mg$
- Electrostatic force, F_e**
 - A force experienced by **charged** objects in an electric field which can be attractive or repulsive e.g. the attraction between a proton and an electron
- Magnetic force, F_m**
 - A force experienced between magnetic poles in a magnetic field that can be attractive or repulsive e.g. the attraction between the north and south poles of magnets

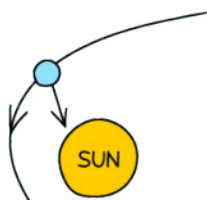

GRAVITATIONAL
ATTRACTION
BETWEEN MASSES



ELECTROSTATIC
FORCES BETWEEN
CHARGES

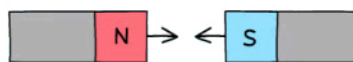

MAGNETIC FORCES
BETWEEN THE POLES
OF MAGNETS

Copyright © Save My Exams. All Rights Reserved

Examples of non-contact forces



Your notes

Worked example

A child drags a sledge behind them as they climb up a hill.

Describe the contact and non-contact forces acting on the child and the sledge.

Answer:

Step 1: Identify the contact forces acting on the child and the sledge

- The child pulls on one end of the rope and the sledge pulls on the other end of the rope
 - This force is **tension**
- The ground pushes against the child and the sledge
 - This is the **normal contact force**
- The surface of the sledge moves over the the surface of the ground opposing the motion of the sledge
 - This force is **surface friction**
- The surfaces of the child's shoes move over the surface of the ground (enabling the child to walk)
 - This force is also **surface friction**
- The child and the sledge move through the air
 - This force is **fluid resistance** or **drag**

Step 2: Identify the non-contact forces acting on the child and the sledge

- The gravitational pull of the Earth acts on the child and the sledge
 - This force is **weight**

Examiner Tip

You will often see weight as W rather than F_g , even on the IB exam papers. It is always best to stick with whichever symbols you have been given in the question. However, if no symbols are given in the question, use the correct symbols from the syllabus (F_g).



Your notes

Frictional Forces

Frictional Forces

- Frictional forces **oppose** the motion of an object
- Frictional forces **slow** down the motion of an object

- When friction occurs, energy is transferred by **heating**
 - This raises the **temperature** (thermal energy) of the objects and their surroundings
 - The work done against frictional forces causes this rise in temperature
- **Fluid resistance** or **drag** occurs when an object moves through a **fluid** (a gas or a liquid)
 - The object collides with the particles in the liquid or gas
 - This slows down the motion of the object and causes heating of the object and the fluid
- **Surface friction** occurs between two **bodies** that are **in contact** with one another
 - **Imperfections** in the surfaces of the objects in contact rub up against each other
 - Not only does this slow the object down but also causes an increase in **thermal energy**

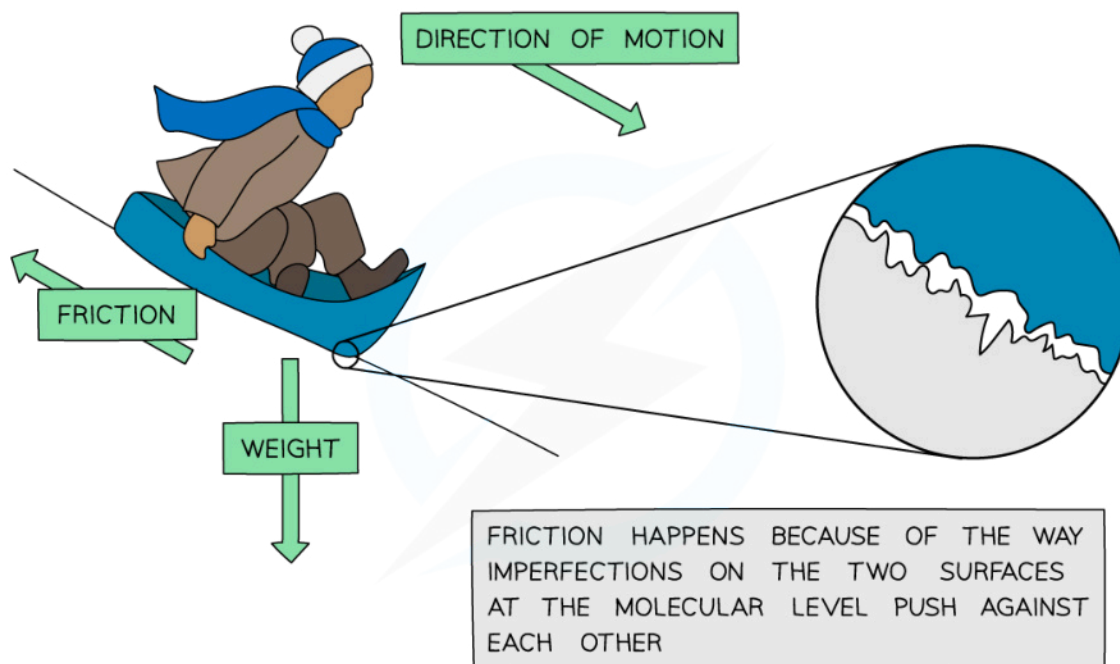

Copyright © Save My Exams. All Rights Reserved

The interface between the ground and the sled is bumpy which is the source of the frictional force

Static & Dynamic Friction

- There are two kinds of **surface friction** to consider for IB DP Physics



Your notes

- **Static friction** occurs when a body is stationary on a surface
- **Dynamic friction** occurs when a body is in motion on a surface, such as in the sledge example above
- The surface frictional force always acts in a direction **parallel** to the plane of contact between a body and a surface
- Both of these forms of friction depend on the **normal reaction force**, F_N of one object sitting upon the other
- Static friction will **match** any push or pull force that acts against it until it can **no longer** hold the two objects stationary
 - Static friction **increases** in magnitude **until movement begins** and dynamic friction occurs
- For any given situation, **static friction** should reach a maximum value that is **larger** than that of **dynamic friction**
 - For a constant pushing force, **dynamic** friction will be a **constant**
- This is because there are more forces at work keeping an object stationary than there are forces working to resist an object once it is in motion

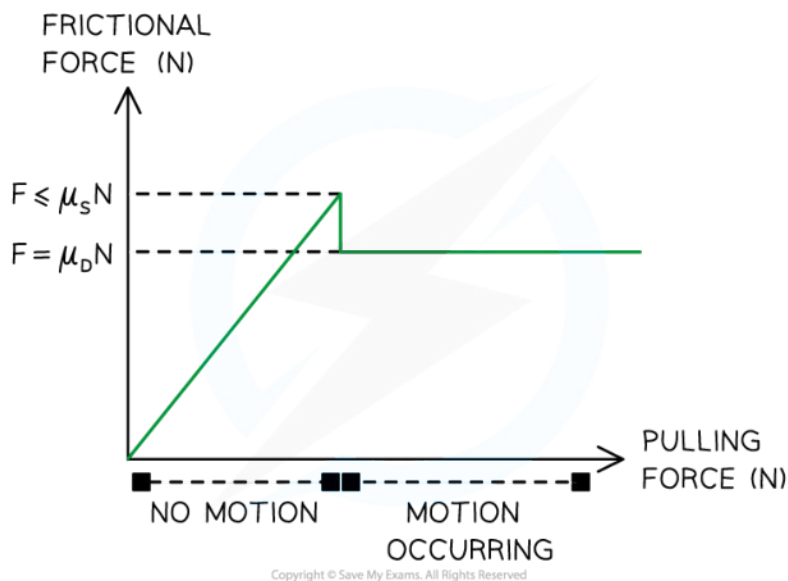

The relationship between frictional forces and motion

- The equation for static friction is given by:

$$F_f \leq \mu_s F_N$$

- Where:
 - F_f = frictional force (N)
 - μ_s = coefficient of static friction
 - F_N = normal reaction force (N)

- The **coefficient** of static **friction** is a number between 0 and 1 but does not include those numbers
 - It is a ratio of the force of static friction and the normal force
 - The **larger** the coefficient of static friction, the **harder** it is to move those two objects past one another
- The equation for dynamic friction is given by:

$$F_f = \mu_d F_N$$

- Where:
 - F_f = frictional force (N)
 - μ_d = coefficient of dynamic friction
 - F_N = normal reaction force (N)
- The coefficient of dynamic friction has similar properties to that of static friction
- However:
 - **dynamic friction** has a **definite force** value for a given situation
 - **static friction** has an **increasing force** value for a given situation



Your notes



Your notes

Worked example

An 8.0 kg block sits on an incline of 20 degrees from the horizontal. It is stationary and does have a frictional force acting upon it.

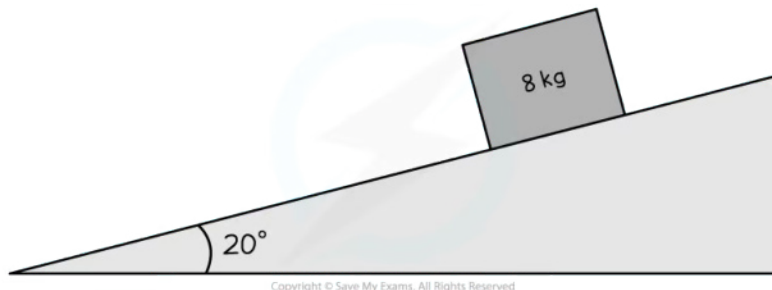

Determine the minimum possible value of the coefficient of static friction.

Answer:

Step 1: List the known quantities

- Mass of the block, $m = 8.0 \text{ kg}$
- Angle between the slope and the horizontal, $\theta = 20^\circ$

Step 2: Determine the weight of the block

- The weight will act directly downward and comes from the interaction of mass and acceleration due to gravity

$$F_g = mg$$

$$F_g = 8.0 \times 9.81 = 78.48 \text{ N downwards}$$

Step 3: Break the weight down into components based on the slope angle



Your notes

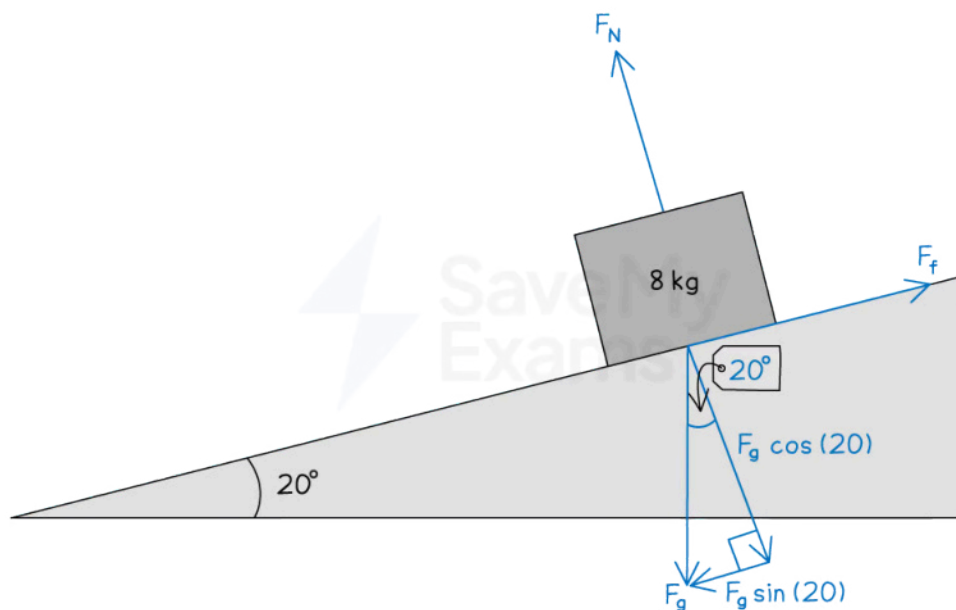

Copyright © Save My Exams. All Rights Reserved

- The component of the weight force that is parallel to the slope provides the force that moves the block down the slope
- This component of the weight force is equal to the surface friction acting up the slope, F_f

$$F_f = F_g \sin \theta$$

$$F_f = 78.48 \times \sin(20) = 26.8 \text{ N}$$

- The component of the weight force that is perpendicular to the slope has the same magnitude as the normal reaction force, F_N

$$F_N = F_g \cos \theta$$

$$F_N = 78.48 \times \cos(20) = 73.7 \text{ N}$$

Step 4: Use the equation of static friction to find the minimum value of the coefficient of static friction

- The equation for static friction is:

$$F_f \leq \mu_s F_N$$

- Rearrange to make the coefficient of static friction the subject

$$\mu_s \geq \frac{F_f}{F_N}$$

$$\mu_s \geq \frac{26.8}{73.7}$$

$$\mu_s \geq 0.36$$

Step 5: State the final answer

- The coefficient for static friction must be **0.36 or greater** for this situation



Your notes



Your notes

Hooke's Law

Hooke's Law

- When a force is applied to each end of a spring, it **stretches**
 - This phenomenon occurs for any material with elasticity, such as a wire or a bungee rope
- A material obeys Hooke's Law if:
 - **The extension of the material is directly proportional to the applied force (load) up to the limit of proportionality**
- This linear relationship is represented by the Hooke's law equation:

$$F_H = -kx$$

- Where:
 - F_H = elastic restoring force (N)
 - k = spring constant (N m^{-1})
 - x = extension (m)
- The spring constant, k is a property of the material being stretched and measures the **stiffness** of a material
 - The **larger** the spring constant, the **stiffer** the material
- Hooke's Law applies to both **extensions** and **compressions**:
 - The extension of an object is determined by how much it has **increased** in length
 - The compression of an object is determined by how much it has **decreased** in length
- The extension x is the difference between the **unstretched** and **stretched** length
 - **extension = stretched length – unstretched length**

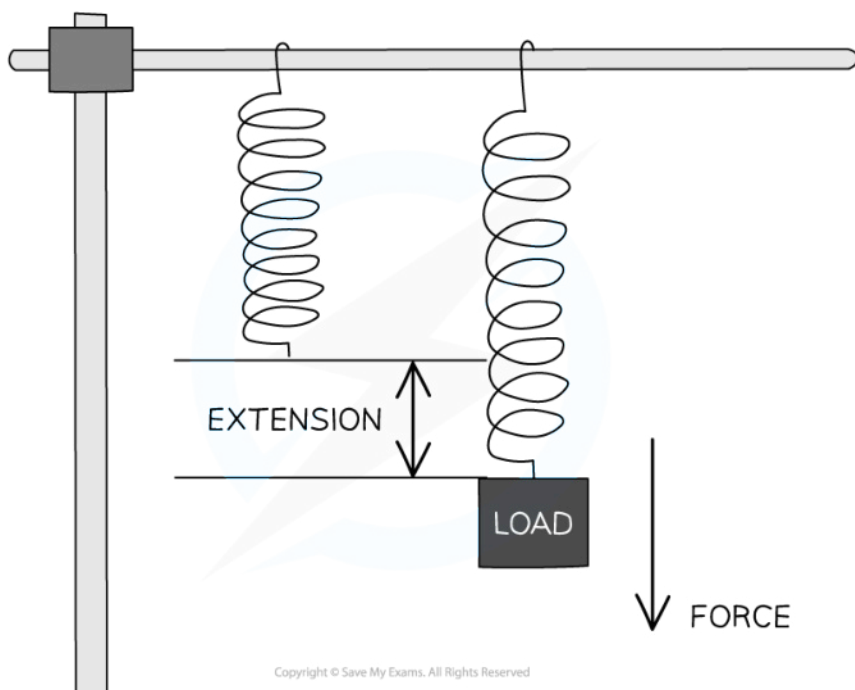

Stretching a spring with a load produces a force that leads to an extension

Force–Extension Graphs

- The way a material responds to a given force can be shown on a force-extension graph
- Every material will have a unique force-extension graph depending on how brittle or ductile it is
- A material may obey Hooke's Law up to a point
 - This is shown on its force-extension graph by a **straight line through the origin**
- As more force is added, the graph starts to curve slightly as Hooke's law no longer applies



Your notes

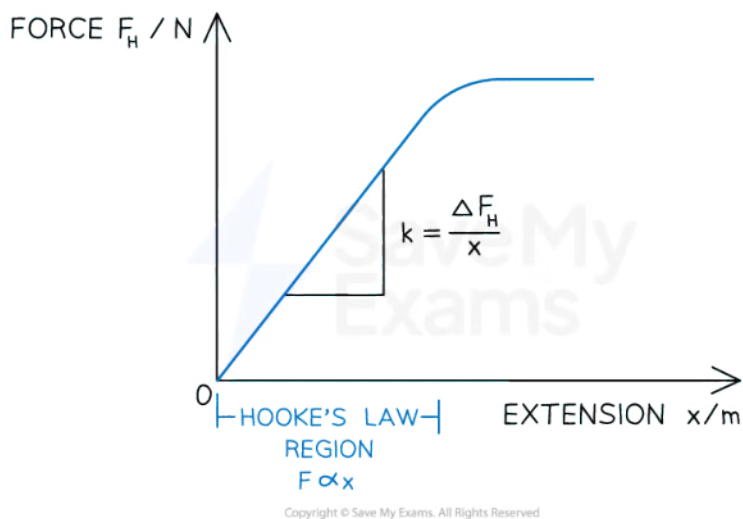

The Hooke's Law region of a force–extension graph is a straight line. The spring constant is the gradient of that region

- The **gradient** of the linear portion of this graph is equal to the **spring constant k**



Your notes

Worked example

A spring was stretched with increasing load.

The graph of the results is shown below.

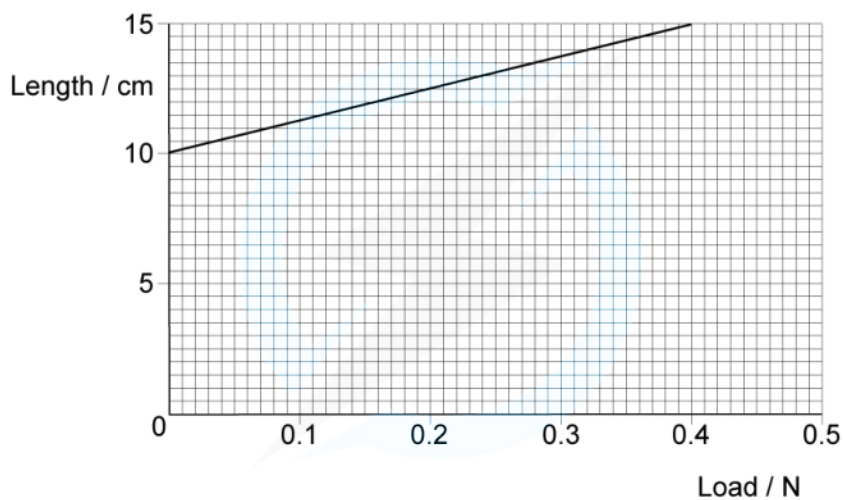

Copyright © Save My Exams. All Rights Reserved

Determine the spring constant.

STEP 1

REARRANGE FROM HOOKE'S LAW, THE SPRING CONSTANT IS

$$k = \frac{F}{\Delta L}$$

STEP 2

THE GRADIENT OF A FORCE-EXTENSION GRAPH IS THE SPRING CONSTANT

$$k = \frac{\Delta F}{\Delta L}$$

Copyright © Save My Exams. All Rights Reserved



Your notes

STEP 3

THIS PARTICULAR GRAPH HAS THE LENGTH ON THE y-AXIS AND THE FORCE ON THE x-AXIS.

THEREFORE THE SPRING CONSTANT IS $\frac{1}{\text{GRADIENT}}$

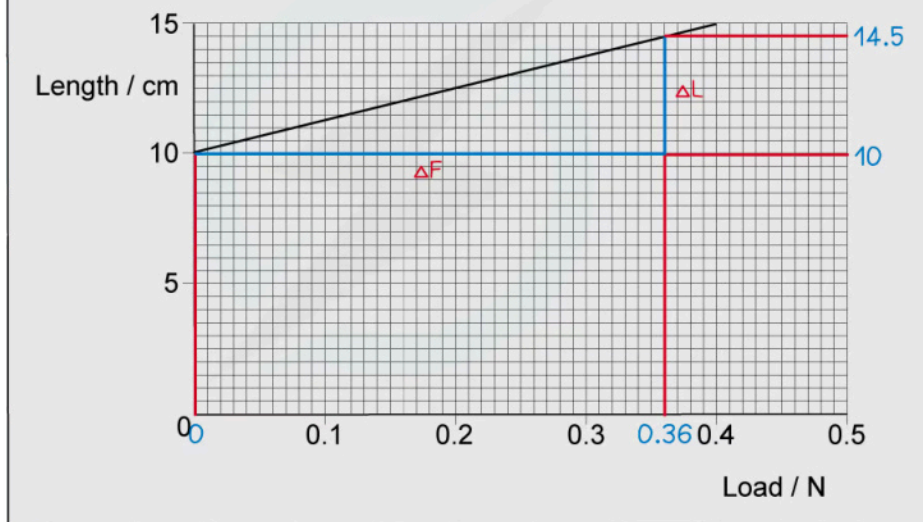

Copyright © Save My Exams. All Rights Reserved

STEP 4

FIND THE GRADIENT

$$\frac{\Delta L}{\Delta F} = \frac{(0.145 - 0.10)\text{m}}{0.36 \text{ N}} = \frac{1}{8.0} \text{ mN}^{-1}$$

$$\text{GRADIENT} = \frac{\Delta y}{\Delta x}$$

STEP 5

SPRING CONSTANT = $\frac{1}{\text{GRADIENT}}$

$$1 \div \frac{1}{8.0} = 8.0 \text{ Nm}^{-1}$$

Copyright © Save My Exams. All Rights Reserved

Examiner Tip

Always double check the axes before finding the spring constant as the gradient of a force-extension graph.

Exam questions often swap the force (or load) onto the x-axis and extension (or length) on the y-axis. In

this case, the gradient is **not** the spring constant, it is $\frac{1}{k}$ instead.

Make sure that you put the **extension** of the object into the equation for x and not just the length.



Your notes



Your notes

Stoke's Law

Stoke's Law

Viscous Drag

- Viscous drag is defined as:
the frictional force between an object and a fluid which opposes the motion between the object and the fluid
- This drag force is often from air resistance
- Viscous drag is calculated using Stoke's Law:

$$F_d = 6\pi\eta rv$$

- Where
 - F_d = viscous drag force (N)
 - η = fluid viscosity (N s m⁻² or Pa s)
 - r = radius of the sphere (m)
 - v = velocity of the sphere through the fluid (ms⁻¹)

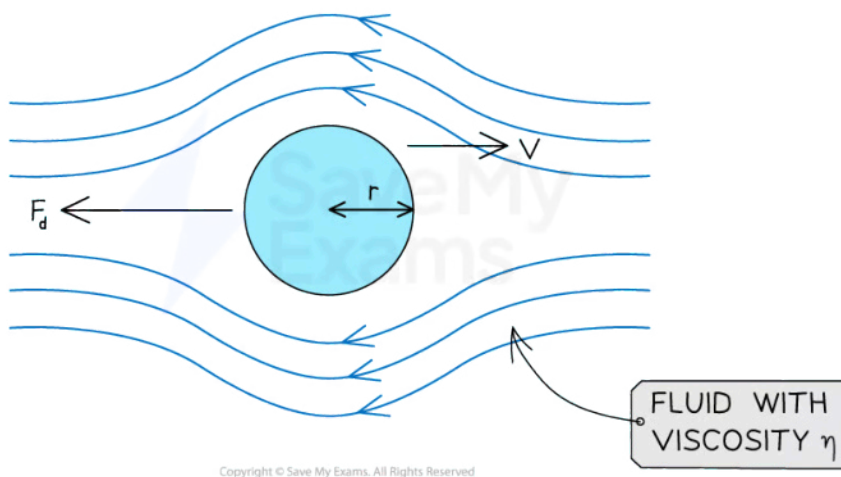

A sphere travelling through air will experience a drag force that depends on its radius, velocity and the viscosity of the liquid

- The viscosity of a fluid can be thought of as its thickness, or how much it resists flowing
 - Fluids with **low viscosity** are **easy** to pour, while those with **high viscosity** are **difficult** to pour

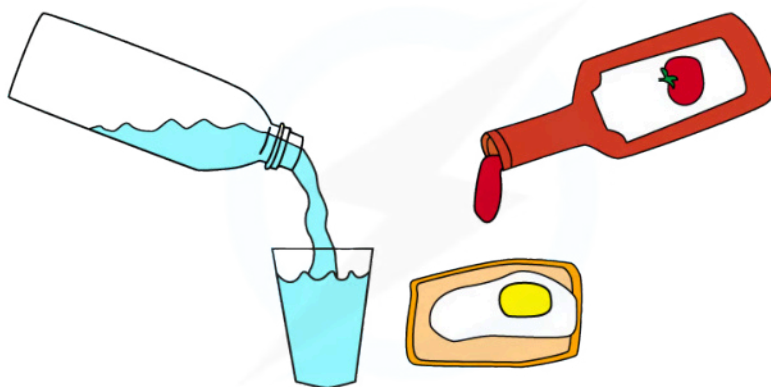

Copyright © Save My Exams. All Rights Reserved



Your notes

Water has a lower viscosity than ketchup as it is easier to pour and flow

- The **coefficient of viscosity** is a property of the fluid (at a given temperature) that indicates how much it will resist flow
 - **The rate of flow** of a fluid is inversely proportional to the coefficient of viscosity
- The size of the force depends on the:
 - Speed of the object
 - Size of the object
 - Shape of the object



Your notes

Worked example

A spherical stone of volume $2.7 \times 10^{-4} \text{ m}^3$ falls through the air and experiences a drag force of 3 mN at a particular instant. Air has a viscosity of $1.81 \times 10^{-5} \text{ Pa s}$. Calculate the speed of the stone at that instant.

Answer:

Step 1: List the known quantities

- Volume of stone, $V = 2.7 \times 10^{-4} \text{ m}^3$
- Drag force, $F_d = 3 \text{ mN} = 3 \times 10^{-3} \text{ N}$
- Viscosity of air, $\eta = 1.81 \times 10^{-5} \text{ Pa s}$

Step 2: Calculate the radius of the sphere, r

- The volume of a sphere is

$$V = \frac{4}{3} \pi r^3$$

- Therefore, the radius, r is:

$$r = \sqrt[3]{\frac{3V}{4\pi}} = \sqrt[3]{\frac{3 \times (2.7 \times 10^{-4})}{4\pi}} = 0.04 \text{ m}$$

Step 3: Rearrange the Stoke's law equation for the velocity, v

$$F_d = 6 \pi \eta r v$$

$$v = \frac{F_d}{6 \pi \eta r}$$

Step 4: Substitute in the known values

$$v = \frac{3 \times 10^{-3}}{6\pi \times (1.81 \times 10^{-5}) \times 0.04} = 220 \text{ m s}^{-1}$$



Your notes

Buoyancy

Buoyancy

- **Buoyancy** is experienced by a body which is partially or totally immersed in a **fluid**
 - The buoyancy force is exerted on a body due to the **displacement** of the fluid it is immersed in
- Buoyancy keeps boats afloat and allows balloons to rise through the air
- When a body travels through a fluid, it also experiences a **buoyancy force** (upthrust) due to the displacement of the fluid

- Buoyancy is calculated using:

$$F_b = \rho Vg$$

- Where:
 - F_b = buoyancy force (N)
 - ρ = density of the fluid (kg m^{-3})
 - V = volume of the fluid displaced (m^3)
 - g = acceleration of free fall (m s^{-2})
- If you were to take a hollow ball and submerge it into a bucket of water, you would feel some resistance
- Some water will flow out of the bucket as it is displaced by the ball
- The buoyancy force, F_b of the water will push upward on the ball
- When you let go of the ball, the buoyancy force of the water on the ball will cause the ball to accelerate to the surface
- The ball will remain stationary floating on the surface of the water
- At this point, the weight of the ball acting downward, F_g , is equal to the buoyancy force acting upwards, F_b

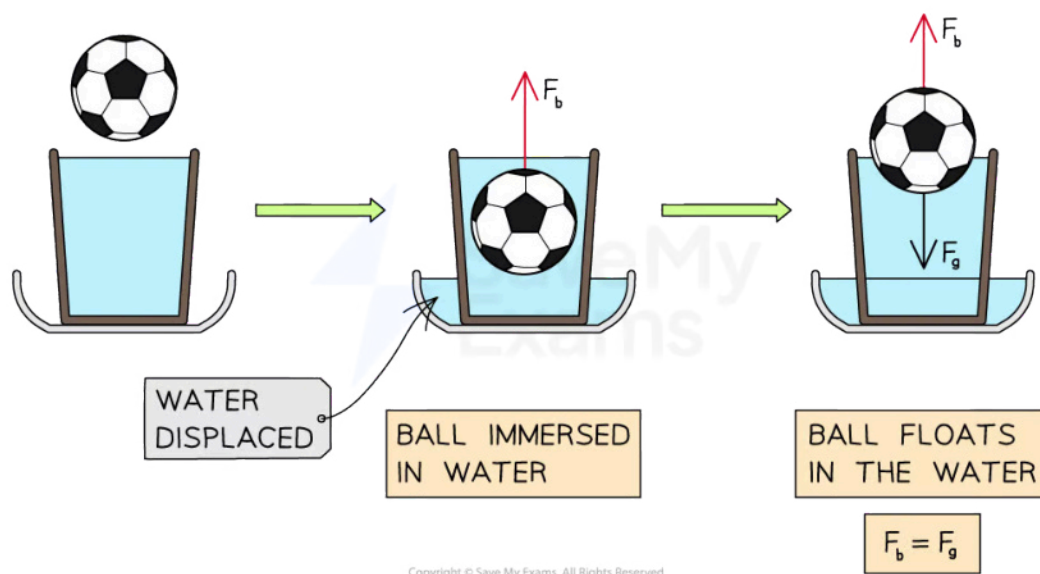

The ball floats when the buoyancy force and its weight are balanced

- Notice that

$$F_g = \rho Vg = \frac{m}{V} Vg = mg$$

- Where:
 - m = mass of the ball (kg)
 - ρ = density of the ball (kg m^{-3})
 - V = volume of the ball (m^3)
- The buoyancy force and the weight force are equal

Drag Force at Terminal Speed

- Terminal velocity, or terminal speed, is useful when working with [Stoke's Law](#)
- This is because, at terminal velocity, the forces in each direction are **balanced**

$$W_s = F_d + F_b \text{ (Equation 1)}$$

- Where:
 - W_s = weight of the sphere (N)
 - F_d = the drag force (N)
 - F_b = the buoyancy force / upthrust (N)

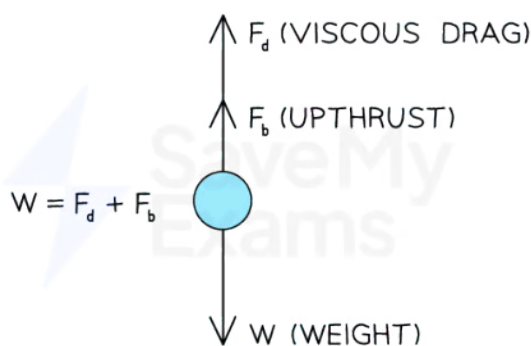

Copyright © Save My Exams. All Rights Reserved

At terminal velocity, the forces on the sphere are balanced

- The weight of the sphere is found using volume, density and gravitational field strength

$$W_s = \rho_s V_s g$$

$$W_s = \frac{4}{3} \pi r^3 \rho_s g \text{ (Equation 2)}$$

- Where

- V_s = volume of the sphere (m^3)
- ρ_s = density of the sphere (kg m^{-3})
- r = radius of the sphere (m)
- g = acceleration of free fall (m s^{-2})

- Recall Stoke's Law

$$F_d = 6 \pi \eta r v \text{ (Equation 3)}$$

- Where

- F_d = viscous drag force (N)
- η = fluid viscosity (N s m^{-2} or Pa s)
- r = radius of the sphere (m)
- v = velocity of the sphere through the fluid (ms^{-1})
 - In this case, v is the **terminal velocity**

- The buoyancy force equals the weight of the displaced fluid

- The **volume** of displaced fluid is the **same** as the **volume** of the sphere
- The **weight** of the fluid is found using **volume, density** and **acceleration of free fall**

$$F_b = \frac{4}{3} \pi r^3 \rho_f g \text{ (Equation 4)}$$

- Substitute equations 2, 3 and 4 into equation 1



Your notes

$$\frac{4}{3} \pi r^3 \rho_s g = 6\pi\eta r v + \frac{4}{3} \pi r^3 \rho_f g$$

- Rearrange to make terminal velocity the subject of the equation

$$v = \frac{\frac{4}{3} \pi r^3 g (\rho_s - \rho_f)}{6\pi\eta r} = \frac{4 \pi r^3 g (\rho_s - \rho_f)}{18\pi\eta r}$$

- Finally, cancel out r from the top and bottom to find an expression for **terminal velocity** in terms of the **radius of the sphere** and the **coefficient of viscosity**

$$v = \frac{2 \pi r^2 g (\rho_s - \rho_f)}{9\pi\eta}$$

- This final equation shows that terminal velocity is:
 - directly proportional** to the **square** of the **radius** of the sphere
 - inversely proportional** to the **viscosity** of the fluid



Your notes

Worked example

Icebergs typically float with a large volume of ice beneath the water. Ice has a density of 917 kg m^{-3} and a volume of V_i .

The density of seawater is 1020 kg m^{-3} .

What fraction of the iceberg is above the water?

- A. $0.10 V_i$ B. $0.90 V_i$ C. $0.97 V_i$ D. $0.20 V_i$

ANSWER: **A**

STEP 1

ACCORDING TO ARCHIMEDES' PRINCIPLE, THE UP THRUST IS EQUAL TO THE WEIGHT OF THE SEAWATER DISPLACED BY THE ICEBERG

$$\text{ICEBERG WEIGHT } W_i = m_i g$$

BUOYANCY FORCE IS THE WEIGHT OF THE DISPLACED WATER

$$W_w = m_w g$$

STEP 2

SINCE THE ICEBERG IS FLOATING, ITS WEIGHT IS EXACTLY EQUAL TO THE BUOYANCY FORCE

$$W_i = W_w$$

$$m_i g = m_w g$$

Copyright © Save My Exams. All Rights Reserved



Your notes

STEP 3 REARRANGE DENSITY EQUATION FOR MASS

$$m = \rho V$$
$$\rho_i V_i g = \rho_w V_w g$$

STEP 4 CANCELLING g SHOWS THE FRACTION OF ICE UNDERWATER IS GIVEN BY RATIO OF DENSITIES

$$\frac{V_i}{V_w} = \frac{\rho_w}{\rho_i}$$

STEP 5 REARRANGE FOR V_w

$$V_w = \frac{\rho_i V_i}{\rho_w}$$

$$V_w = \frac{917}{1020} V_i = 0.9 V_i$$

STEP 6 THEREFORE 90% OF THE ICEBERG'S VOLUME IS SUBMERGED UNDERWATER

THIS MEANS THAT $1 - 0.9 = 0.1 V_i$ IS ABOVE WATER

Copyright © Save My Exams. All Rights Reserved

 **Examiner Tip**Remember that ρ in the buoyancy force equation is the density of the **fluid** and **not** the object itself!



Your notes

Conservation of Linear Momentum

Conservation of Linear Momentum

Linear Momentum

- When an object with **mass** is in motion and therefore has a **velocity**, the object also has **momentum**
- **Linear momentum** is the momentum of an object that is moving in only **one dimension**
- The linear momentum of an object remains **constant** unless an external resultant force acts upon the system
- **Momentum** is defined as the product of mass and velocity

$$p = mv$$

- Where:
 - p = momentum, measured in kg m s^{-1}
 - m = mass, measured in kg
 - v = velocity, measured in m s^{-1}

Direction of Momentum

- Momentum is a **vector** quantity with both **magnitude** and **direction**
 - The initial direction of motion is usually assigned the positive direction
- If a ball of mass 60 g travels at 2 m s^{-1} , it will have a momentum of 0.12 kg m s^{-1}
- If it then hits a wall and rebounds in the exact opposite direction at the same speed, it will have a momentum of $-0.12 \text{ kg m s}^{-1}$



Your notes

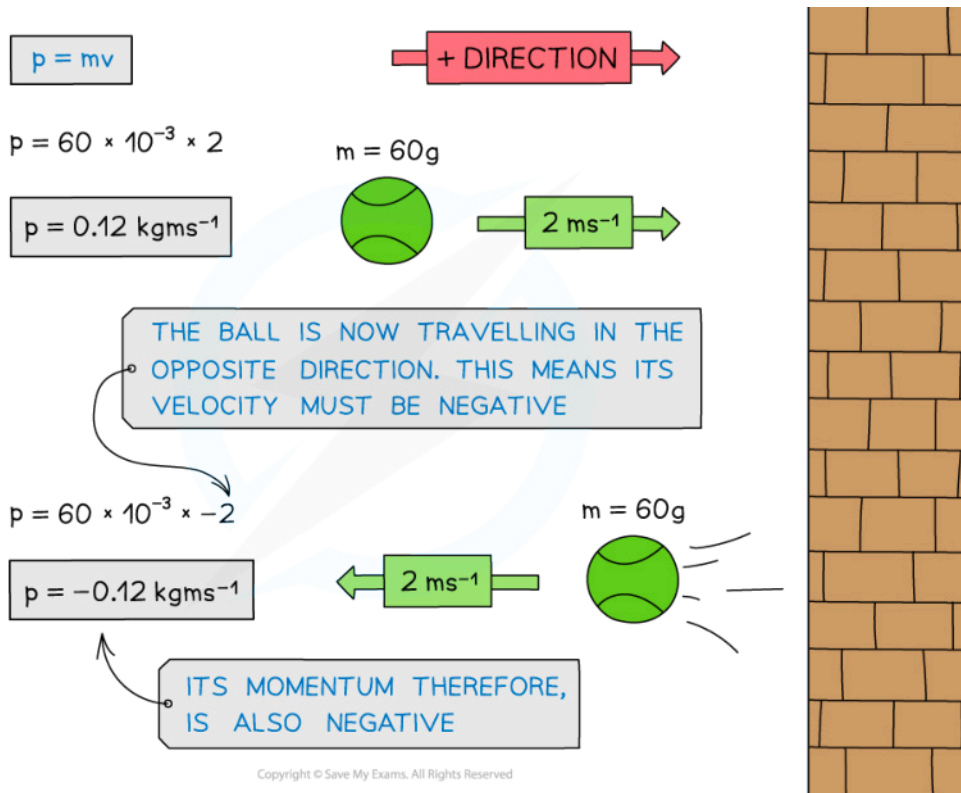

When the ball is travelling in the opposite direction, its velocity is negative. Since momentum = mass \times velocity, its momentum is also negative

Conservation of Linear Momentum

- The principle of conservation of linear momentum states that:
The total linear momentum before a collision is equal to the total linear momentum after a collision unless the system is acted on by a resultant external force
- Therefore:

$$\text{momentum before} = \text{momentum after}$$
- Momentum is a **vector** quantity, therefore:
 - opposing vectors** can cancel each other out, resulting in a **net momentum** of zero
 - an object that collides with another object and **rebounds**, has a **positive** velocity **before** the collision and a **negative** velocity **after**
- Momentum, just like energy, is **always conserved**
- For example:
 - Ball A moves with an initial velocity of u_A
 - Ball A collides with Ball B which is stationary
- After the collision, both balls travel in opposite directions



Your notes

- Taking the direction of the initial motion of Ball A as the positive direction (to the right)
- The momentum **before** the collision is

$$p_{\text{before}} = m_A u_A + 0$$

- The momentum **after** the collision is

$$p_{\text{after}} = -m_A v_A + m_B v_B$$

- The minus sign shows that Ball A travels in the **opposite** direction to the initial travel
 - If an object is stationary, like Ball B before the collision, then it has a momentum of **zero**

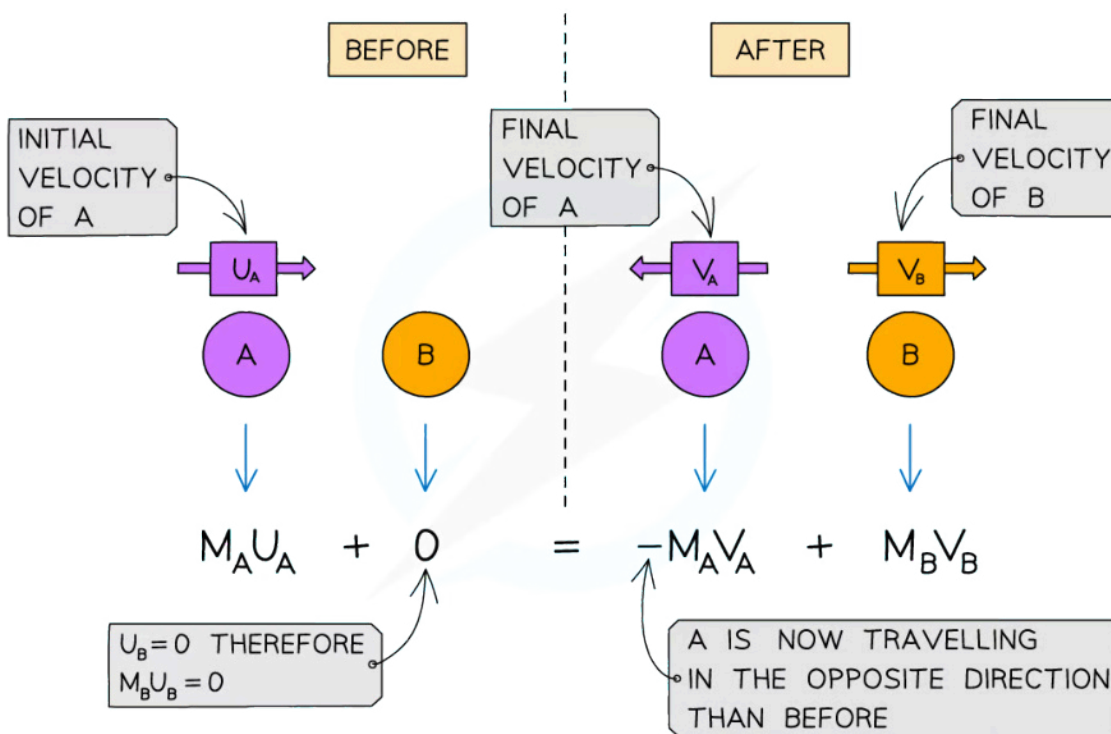

The conservation of momentum for two objects A and B colliding then moving apart



Your notes

Worked example

A tennis ball of mass 60 g travels to the right with a speed of 75 m s^{-1} .

A brick of mass 3 kg is thrown to the right at a speed of 1.5 m s^{-1} .

Determine which object has the greatest momentum.

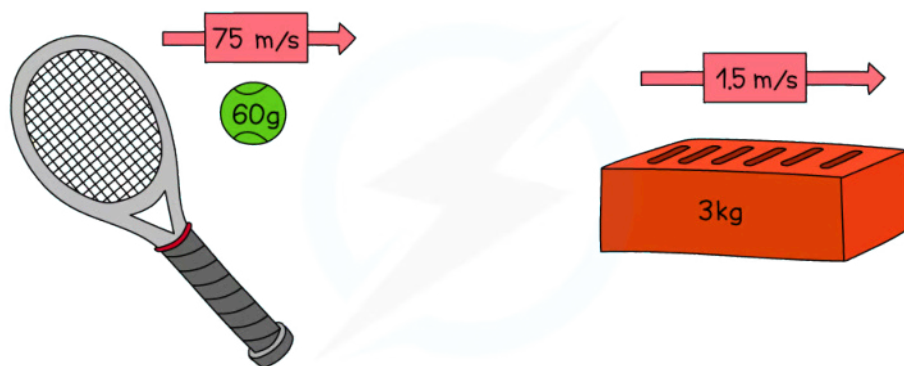

Copyright © Save My Exams. All Rights Reserved

Answer:

$$\text{MOMENTUM} = \text{MASS} \times \text{VELOCITY}$$

$$\begin{aligned} \text{MOMENTUM} &= 0.06 \text{ kg} \times 75 \text{ m/s} \\ &= 4.5 \text{ kgm/s} \end{aligned}$$

$$\text{MOMENTUM} = \text{MASS} \times \text{VELOCITY}$$

$$\begin{aligned} \text{MOMENTUM} &= 3 \text{ kg} \times 1.5 \text{ m/s} \\ &= 4.5 \text{ kgm/s} \end{aligned}$$

Copyright © Save My Exams. All Rights Reserved

- Both the tennis ball and the brick have the **same momentum**
- Even though the brick is much **heavier** than the ball, the ball is travelling much **faster** than the brick
- This means that on impact, they would both exert a **similar force** (depending on the time it takes for each to come to rest)



Your notes

Worked example

Trolley **A** of mass 0.80 kg collides head-on with stationary trolley **B** whilst travelling at 3.0 m s^{-1} .

Trolley **B** has twice the mass of trolley **A**. On impact, the trolleys stick together.

Using the conservation of momentum, calculate the common velocity of both trolleys after the collision.

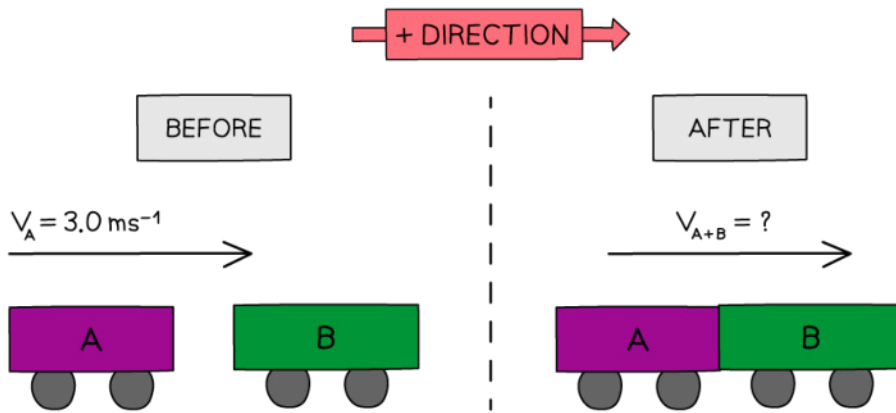

$$\begin{aligned} \text{MOMENTUM} &= (M_A \times V_A) + (M_B \times V_B) \\ \text{BEFORE} & \\ &= (0.8 \text{ kg} \times 3.0 \text{ ms}^{-1}) + 0 \\ &= 2.4 \text{ kgms}^{-1} \end{aligned}$$

SINCE TROLLEY B IS STATIONARY, $v = 0$ THEREFORE ITS MOMENTUM IS 0

$$\begin{aligned} \text{MOMENTUM} &= (M_A + M_B) \times V_{A+B} \\ \text{AFTER} & \\ &= (0.8 \text{ kg} + 1.60 \text{ kg}) \times V_{A+B} \\ &= 2.4 \text{ kg} \times V_{A+B} \end{aligned}$$

TROLLEY B HAS TWICE THE MASS OF TROLLEY A

THE PRINCIPLE OF CONSERVATION OF MOMENTUM STATES THAT THE TOTAL MOMENTUM OF A SYSTEM REMAINS CONSTANT PROVIDED NO EXTERNAL FORCE ACTS ON IT

$$\text{MOMENTUM BEFORE} = \text{MOMENTUM AFTER}$$

$$2.4 \text{ kgms}^{-1} = 2.4 \text{ kg} \times V_{A+B}$$

$$V_{A+B} = \frac{2.4 \text{ kgms}^{-1}}{2.4 \text{ kg}}$$

REARRANGING FOR V_{A+B}

$$V_{A+B} = 1.0 \text{ ms}^{-1}$$



Your notes

Worked example

The diagram shows a car and a van which is initially at rest, just before and just after the car collides with the van.

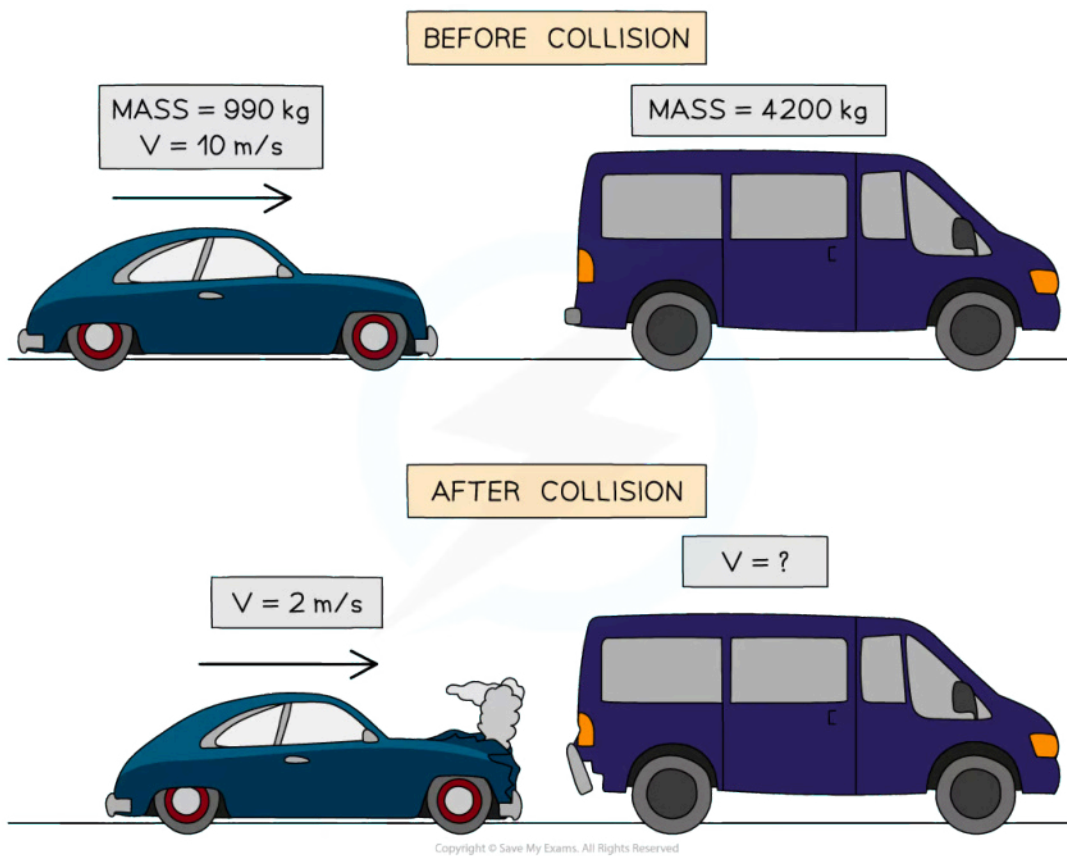

Use the idea of conservation of momentum to calculate the velocity of the van when it is pushed forward by the collision.

Answer:

Step 1: State the principle of the conservation of momentum

- In a closed system, the total momentum before an event is equal to the total momentum after the event

Step 2: Calculate the total momentum before the collision

$$p = mv$$

- Momentum of car:

$$p_{\text{car}} = 990 \times 10 = 9900 \text{ kg m/s}$$



Your notes

- Momentum of van:

The van is at rest, therefore $v = 0$ m/s and $p_{van} = 0$ kg m/s

- Total momentum before:

$$p_{before} = 9900 + 0 = 9900 \text{ kg m/s}$$

Step 3: Calculate the momentum after the collision

- Conservation of momentum states that total momentum after collision = 9900 kg m/s
- Momentum of car:

$$p_{car} = 990 \times 2 = 1980 \text{ kg m/s}$$

- Momentum of van:

$$p_{van} = 4200 \times v = 4200v \text{ kg m/s}$$

Step 4: Calculate the velocity of the van after the collision

- Total momentum after collision:

$$p_{car} + p_{van} = 1980 + 4200v = 9900$$

- Rearrange to make v the subject:

$$4200v = 9900 - 1980$$

$$v = \frac{7920}{4200} = 1.89 \text{ m/s}$$

- The velocity of the van when it is pushed forward by the collision $v = 1.89$ m/s

Examiner Tip

If it is not given in the question already, drawing a diagram of before and after helps keep track of all the masses and velocities (and directions) in the conversation of momentum questions. Even if one is given, label all the values that you have been given in the question to make sure you're substituting in the correct masses and velocities.



Your notes

Impulse & Momentum

Impulse & Momentum

- When an external resultant force acts on an object for a very short time and changes the object's motion, we call this **impulse**
 - For example:
 - Kicking a ball
 - Catching a ball
 - A collision between two objects
- Impulse is the **product** of the **force** applied and the **time** for which it acts

$$J = F\Delta t$$

- Where:
 - J = impulse, measured in newton seconds (N s)
 - F = resultant external force applied, measured in newtons (N)
 - Δt = change in time over which the force acts, measured in seconds (s)
- Because the force is acting for only a short time, it is very difficult to **directly** measure the magnitude of the force or the time for which it acts
- Instead, it can be measured **indirectly**
- Newtons' second law can be stated in terms of momentum

The resultant force on an object is equal to its rate of change of momentum

- Therefore:

$$F = \frac{\Delta p}{\Delta t} \Rightarrow \Delta p = F\Delta t$$

- Where:
 - F = resultant force, measured in newtons (N)
 - Δp = change in momentum, measured in kilogram metres per second (kg m s^{-1})
 - Δt = change in time over which the force acts, measured in seconds (s)
- Change in momentum** is equal to **impulse**
- Therefore, change in momentum can be used to measure impulse indirectly

$$J = \Delta p = mv - mu$$

- Where:
 - J = impulse, measured in newton seconds (N s)
 - Δp = change in momentum, measured in kilogram metres per second (kg m s^{-1})



Your notes

- m = mass, measured in kilograms (kg)
- V = final velocity, measured in meters per second (m s^{-1})
- u = initial velocity, measured in meters per second (m s^{-1})
- These equations are only used when the force F is **constant**
- **Impulse**, like force and momentum, is a **vector** quantity with both a **magnitude** and **direction**
- The impulse is always in the **direction** of the **resultant force**
- A **small force acting over a long time** has the same effect as a **large force acting over a short time**

Examiner Tip

If you follow the units in your calculations (which is always a good idea!), the base units for the newton are:

$$1 \text{ N} = 1 \text{ kg m s}^{-2}$$

This is why $F\Delta t = \Delta p$

- $\text{kg m s}^{-2} \times \text{s} = \text{kg m s}^{-1}$

Impulse Examples

- When rain and hail (frozen water droplets) hit an umbrella they feel very different. This is an example of impulse.
 - Water droplets tend to splatter and roll off the umbrella because there is only a very **small** change in momentum
 - Hailstones have a **larger mass** and tend to bounce back off the umbrella, because there is a **greater** change in momentum
 - Therefore, the impulse that the umbrella applies on the hail stones is **greater** than the impulse the umbrella applies on the raindrops
 - This means that **more force** is required to hold an umbrella upright in hail compared to rain



Your notes

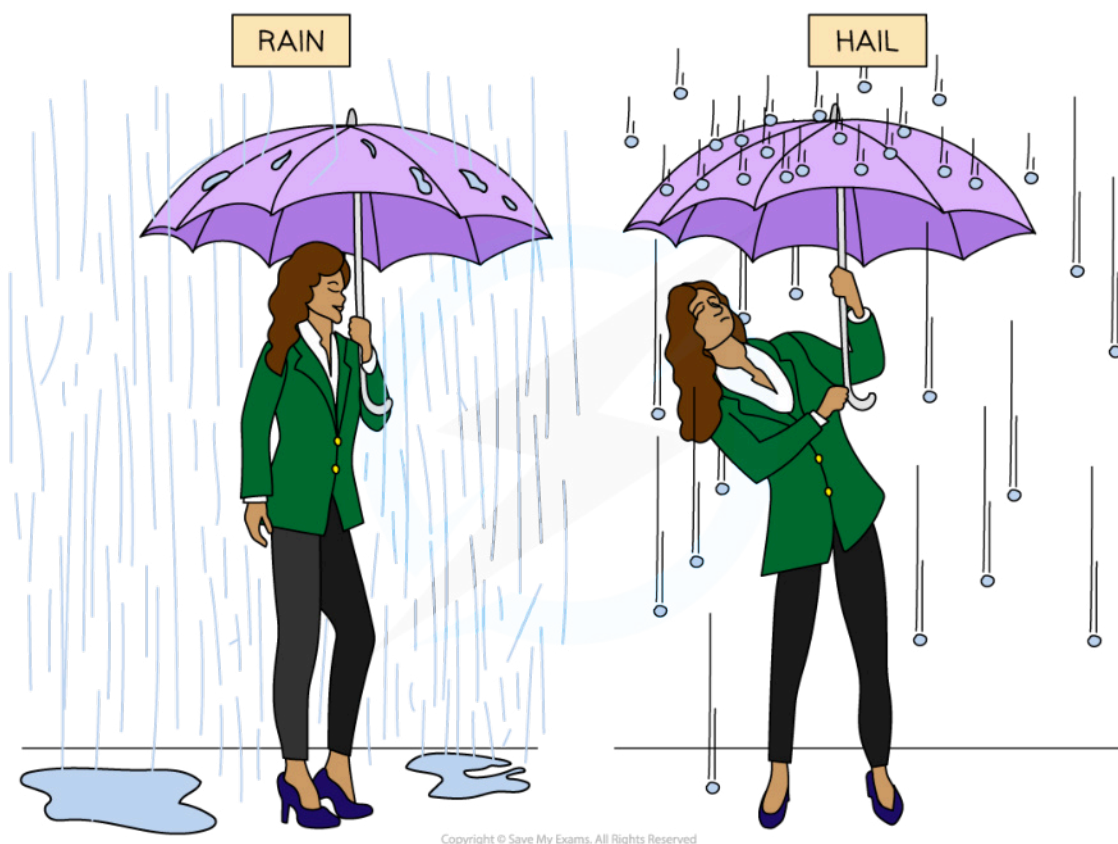

Copyright © Save My Exams. All Rights Reserved

The impulse applied by the umbrella to the hail stones is greater than the impulse applied to the rain drops

- The concept of impulse is used to prevent injury
 - Increasing the time over which the change in momentum occurs, reduces the force experienced by the person
- For example, in cricket:
 - A cricket ball travels at very high speeds and therefore has a **high momentum**
 - When a fielder catches the ball, the ball exerts a force on their hands
 - Stopping a ball with high momentum abruptly will exert a large force on their hands
 - This is because the change in momentum (impulse) acts over a **short period of time** which creates a **large force** on the fielder's hands and could cause serious injury
 - A fielder moves their hands back when they catch the ball, which **increases the time** for the change in momentum to occur
 - This means there will be **less force** exerted on the fielder's hands and therefore, less chance of injury



Your notes

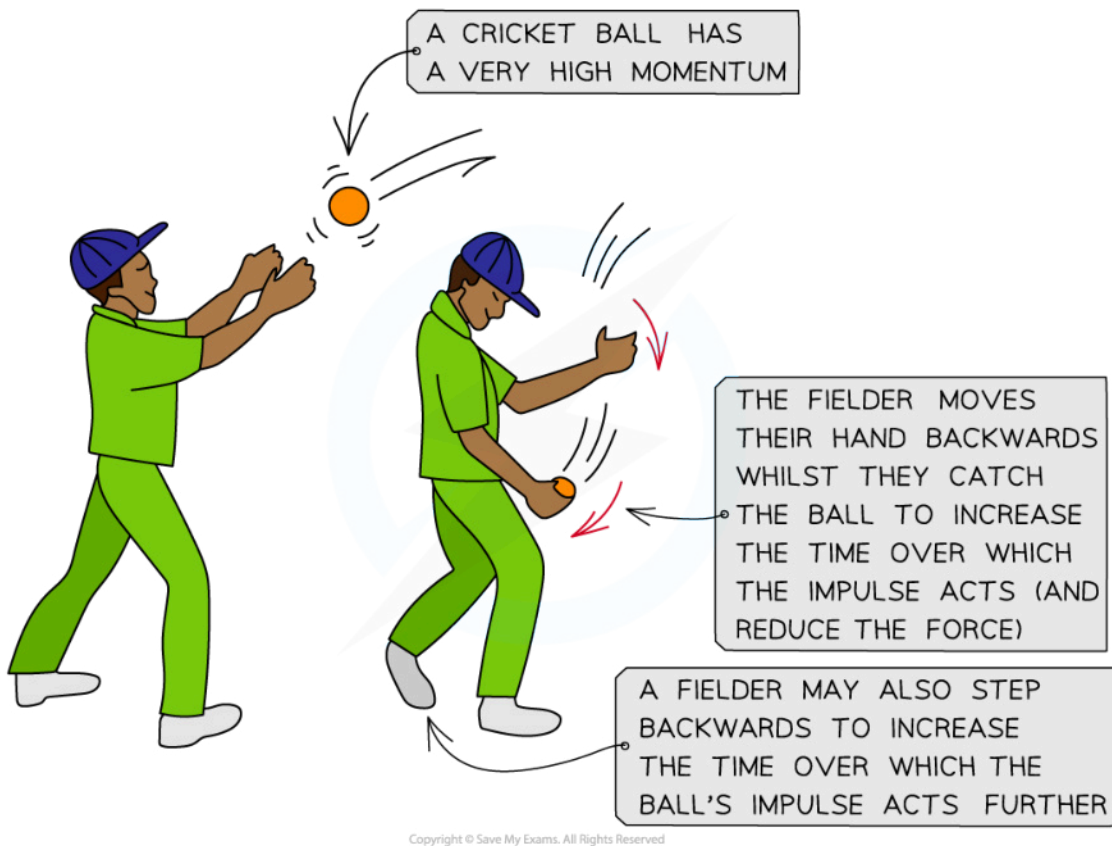

A cricket fielder moves their hands backwards when catching a cricket ball to reduce the force it will exert on their hands



Your notes

Worked example

A 58 g tennis ball moving horizontally to the left at a speed of 30 m s^{-1} is struck by a tennis racket which returns the ball to the right at 20 m s^{-1} .

- (a) Calculate the impulse of the racket on the ball
- (b) State the direction of the impulse

Answer:

(a)

Step 1: List the known quantities

- Taking the direction of the initial motion of the ball as positive (the left)
 - Initial velocity, $u = 30 \text{ m s}^{-1}$
 - Final velocity, $v = -20 \text{ m s}^{-1}$
 - Mass, $m = 58 \text{ g} = 58 \times 10^{-3} \text{ kg}$

Step 2: Write down the impulse equation

$$J = \Delta p = mv - mu = m(v - u)$$

Step 3: Substitute in the known values

$$J = (58 \times 10^{-3}) \times (-20 - 30) = -2.9 \text{ N s}$$

(b)

Step 1: State the direction of the impulse

- Since the impulse is negative, it must be in the opposite direction to which the tennis ball was initially travelling
- Therefore, (since the left is taken as positive) the direction of the impulse is to the **right**

Examiner Tip

Remember that if an object changes direction, then this must be reflected by the change in the sign of the velocity (and impulse). This is the most common mistake made by students. Velocity, impulse, force and momentum are all **vectors!**

For example, if the left is taken as positive and therefore the right as negative, an impulse of 20 N s to the right is equal to -20 N s



Your notes

Force & Momentum

Force & Momentum

- The resultant force on a body is the **rate of change of momentum**
- The change in momentum is defined as:

$$\Delta p = p_f - p_i$$

- Where:
 - Δp = change in momentum (kg m s^{-1})
 - p_f = final momentum (kg m s^{-1})
 - p_i = initial momentum (kg m s^{-1})
- These can be expressed as follows:

$$F = \frac{\Delta p}{\Delta t}$$

- Where:
 - F = resultant force (N)
 - Δt = change in time (s)
- This equation can be used in situations where the **mass** of the body is **not** constant
- It should be noted that the force in this situation is equivalent to [Newton's second law](#):

$$F = ma$$

- This equation can **only** be used when the **mass** is **constant**
- The force and momentum equation can be derived from Newton's second law and the definition of acceleration



Your notes

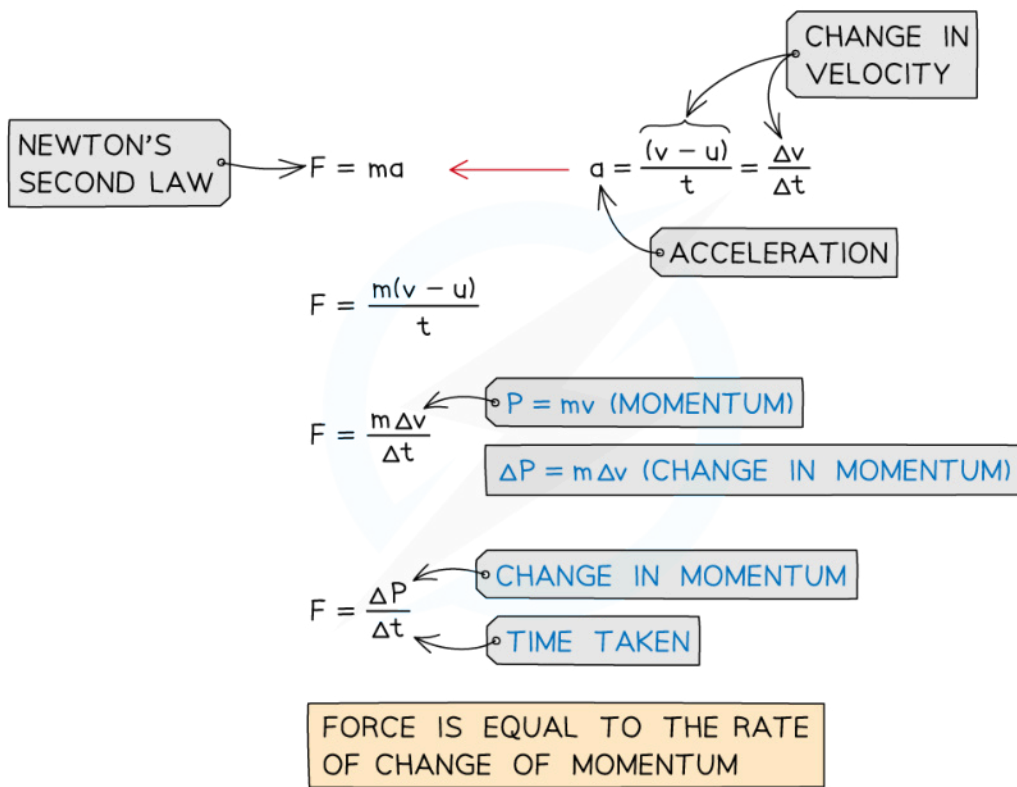

Copyright © Save My Exams. All Rights Reserved

Direction of Forces

- Force and momentum are **vector** quantities with both **magnitude** and **direction**
- The force that is equal to the rate of change of momentum is still the **resultant force**
- The positive direction is taken to be the direction of the initial motion; therefore:
 - a force on an object will be negative if the force opposes its initial velocity
 - the opposing force is exerted by the object it has collided with
 - the forces will be of equal magnitude and opposite in direction, in accordance with [Newton's Third Law](#)



Your notes

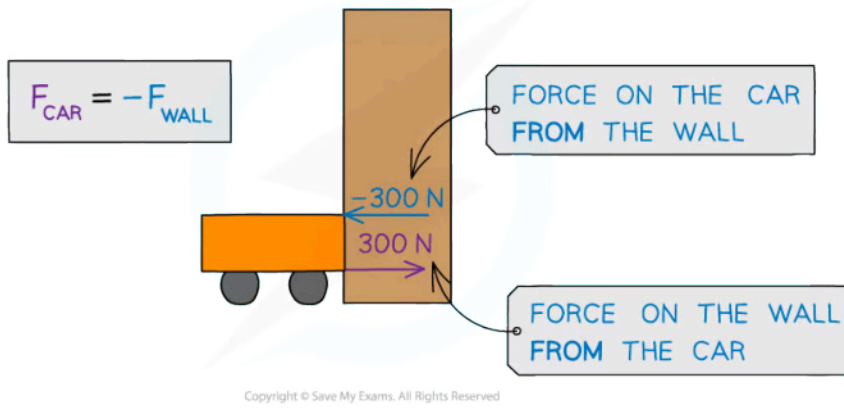

The car exerts a force on the wall of 300 N, and due to Newton's third law, the wall exerts a force of -300N on the car



Your notes

Worked example

A car of mass 1500 kg hits a wall at an initial velocity of 15 m s⁻¹.

It then rebounds off the wall at 5 m s⁻¹. The car is in contact with the wall for 3.0 seconds.

Calculate the average force experienced by the car.

STEP 1

FORCE IS EQUAL TO THE RATE OF CHANGE
IN MOMENTUM

$$F = \frac{\Delta p}{\Delta t}$$

STEP 2

CHANGE IN MOMENTUM

$$\Delta p = \text{FINAL MOMENTUM} - \text{INITIAL MOMENTUM}$$

STEP 3

INITIAL MOMENTUM

INITIAL MOMENTUM = MASS × INITIAL VELOCITY

$$P_i = m \times v_i$$
$$= 1500 \text{ kg} \times 15 \text{ ms}^{-1}$$

$$P_i = 22500 \text{ kgms}^{-1}$$

Copyright © Save My Exams. All Rights Reserved



Your notes

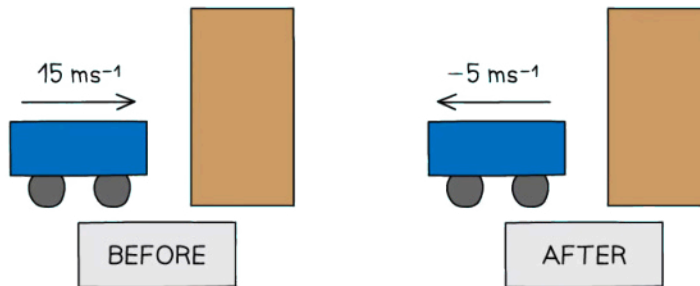

STEP 4

FINAL MOMENTUM

FINAL MOMENTUM = MASS × FINAL VELOCITY

$$\begin{aligned}
 P_f &= m \times v_f \\
 &= 1500 \text{ kg} \times -5 \text{ ms}^{-1}
 \end{aligned}$$

$$P_f = -7500 \text{ kgms}^{-1}$$

STEP 5

 CALCULATE CHANGE IN MOMENTUM Δp

$$\Delta p = -7500 - 22500 = -30000 \text{ kgms}^{-1}$$

STEP 6

SUBSTITUTE THIS VALUE BACK INTO THE FORCE EQUATION

$$F = \frac{\Delta p}{\Delta t} = \frac{-30000}{3} = -10000 \text{ N}$$

Copyright © Save My Exams. All Rights Reserved

Examiner Tip

The direction you consider positive is **your choice**, as long the signs of the numbers (positive or negative) are **consistent** with this throughout the question.

In an exam question, carefully consider what forces are exerted on what objects. Look out for words such as '**from**', '**acting on**' or '**exerted on**' to determine this, and sketch a quick free body force diagram if you need to.



Your notes

Collisions & Explosions in One-Dimension

Collisions & Explosions in One-Dimension

- In both collisions and explosions, **momentum is always conserved**
 - However, **kinetic energy** might not always be

Elastic and inelastic collisions

- Collisions** are when two or more moving objects come together and exert a force on one another for a relatively short time
- Explosions** are when two or more objects that are initially at rest are propelled apart from one another
- Collisions and explosions are either:
 - Elastic** – if the kinetic energy **is** conserved
 - Inelastic** – if the kinetic energy is **not** conserved
- A perfectly **elastic collision** is an idealised situation that does not actually occur everyday life
- Perfectly elastic collisions **do** occur commonly between **particles**
 - All collisions occurring on a macroscopic level are **inelastic collisions**
 - However, exam questions can use the theoretical idea of an elastic collision on a macroscopic level
- A **totally inelastic collision** is a special case of an inelastic collision where the colliding bodies **stick together** and move as one body
- In a totally inelastic collision, the **maximum** amount of **kinetic energy** is transferred away from the moving bodies and is dissipated to the surroundings

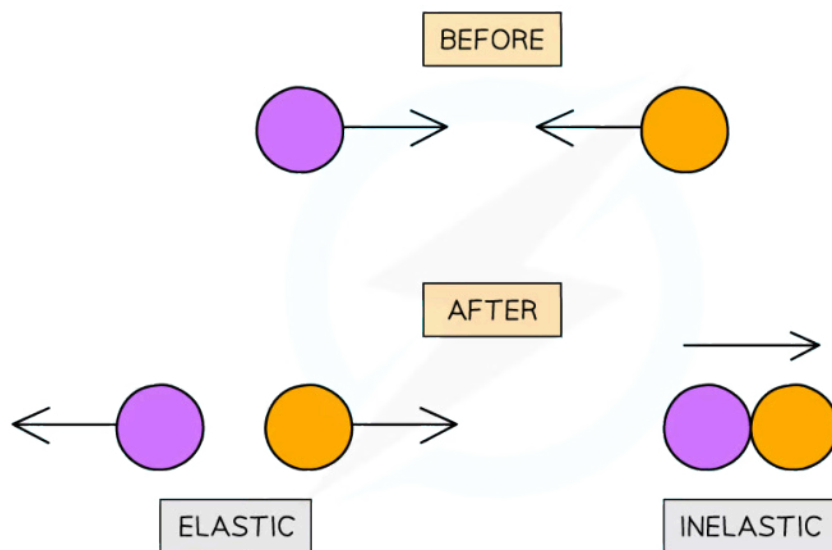

Copyright © Save My Exams. All Rights Reserved

Elastic collisions are where two objects move in opposite directions. Inelastic collisions are where two objects stick together

- An explosion is commonly to do with **recoil**
 - For example, a gun recoiling after shooting a bullet or an unstable nucleus emitting an alpha particle and a daughter nucleus
- To find out whether a collision is elastic or inelastic, **compare the kinetic energy before and after the collision**
- The equation for kinetic energy is:

$$E_k = \frac{1}{2}mv^2$$

- Where:
 - E_k = kinetic energy (J)
 - m = mass (kg)
 - v = velocity (m s^{-1})

Examiner Tip

It can be helpful to think about collisions and explosions as if there are four types rather than two:

- **elastic** - kinetic energy conserved
- **perfectly elastic** - kinetic energy conserved **and** no energy transferred between objects
- **inelastic** - kinetic energy not conserved
- **totally inelastic** - kinetic energy not conserved **and** maximum energy transferred to surroundings



Your notes



Your notes

Worked example

Two similar spheres, each of mass m and velocity v are travelling towards each other. The spheres have a head-on elastic collision.

What is the total kinetic energy after the impact?



A. $\frac{1}{2}mv^2$

B. 0

C. mv^2

D. $2mv$

ANSWER: C

IN AN ELASTIC COLLISION, KINETIC ENERGY IS CONSERVED.

THIS MEANS KINETIC ENERGY BEFORE = KINETIC ENERGY AFTER.

$$\text{KINETIC ENERGY BEFORE} = \frac{1}{2}mv^2 + \frac{1}{2}mv^2 = mv^2.$$

IN AN ELASTIC COLLISION, KINETIC ENERGY AFTER WILL ALSO EQUAL mv^2 .

Copyright © Save My Exams. All Rights Reserved



Your notes

Worked example

Trolley **A** of mass 0.80 kg collides head-on with stationary trolley **B** at speed 3.0 m s^{-1} . Trolley **B** has twice the mass of trolley **A**. The trolleys stick together and travel at a velocity of 1.0 m s^{-1} .

Determine whether this is an elastic or inelastic collision.

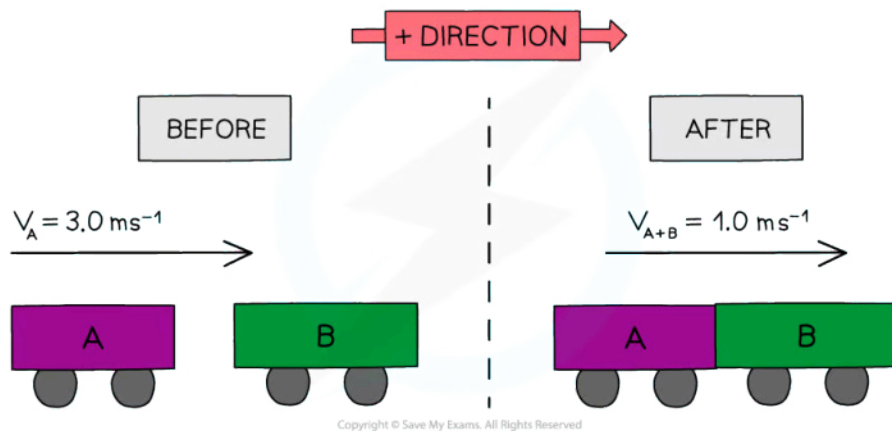

$$\text{KINETIC ENERGY} = \frac{1}{2} m v^2$$

$$\begin{aligned} \text{KINETIC ENERGY BEFORE} &= \frac{1}{2} \times M_A \times (v_A)^2 + \frac{1}{2} \times M_B \times (v_B)^2 \\ &= \frac{1}{2} \times 0.8 \times (3.0)^2 + 0 \leftarrow v_B = 0 \\ &= 3.6 \text{ J} \end{aligned}$$

$$\begin{aligned} \text{KINETIC ENERGY AFTER} &= \frac{1}{2} \times M_{A+B} \times (v_{A+B})^2 \\ &= \frac{1}{2} \times 2.4 \times (1.0)^2 \\ &= 1.2 \text{ J} \end{aligned}$$

THIS IS AN INELASTIC COLLISION SINCE KINETIC ENERGY IS NOT CONSERVED

Copyright © Save My Exams. All Rights Reserved

 **Examiner Tip**

If an object is **stationary** or at **rest**, its initial velocity is **0**, therefore, the momentum and kinetic energy are also equal to 0.

When a collision occurs in which two objects are stuck together, treat the final object as a **single** object with a **mass** equal to the **sum** of the masses of the two individual objects.

Despite velocity being a vector, kinetic energy is a **scalar** quantity and therefore will **never** include a minus sign - this is because in the kinetic energy formula, mass is scalar and the v^2 will always give a positive value whether it's a negative or positive velocity.



Your notes



Your notes

Collisions & Explosions in Two-Dimensions (HL)

Collisions & Explosions in Two-Dimensions

- We know that momentum is always **conserved**
- This doesn't just apply to the motion of colliding objects in one dimension (in one line), but this is true in **every** direction
- Since momentum is a **vector**, it can be split into its horizontal and vertical component
 - This is done by **resolving vectors**
- Consider again the two colliding balls A and B
- Before the collision, ball A is moving at speed u_A and hits stationary ball B
 - Ball A moves away at speed v_A and angle θ_A
 - Ball B moves away at speed v_B and angle θ_B

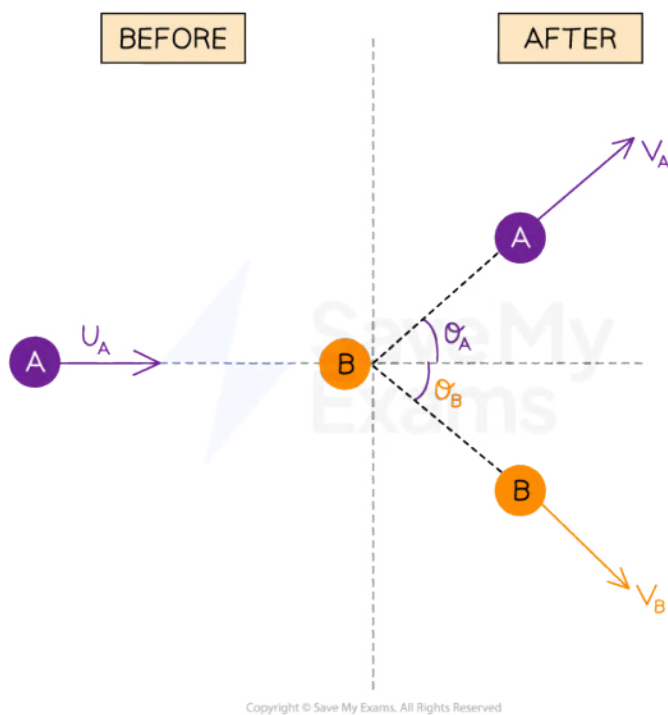

- This time, they move off in different directions, so we now need to consider their momentum in the x direction **and** separately, their momentum in the y direction
 - This is done by resolving the **velocity** vector of each ball after the collision

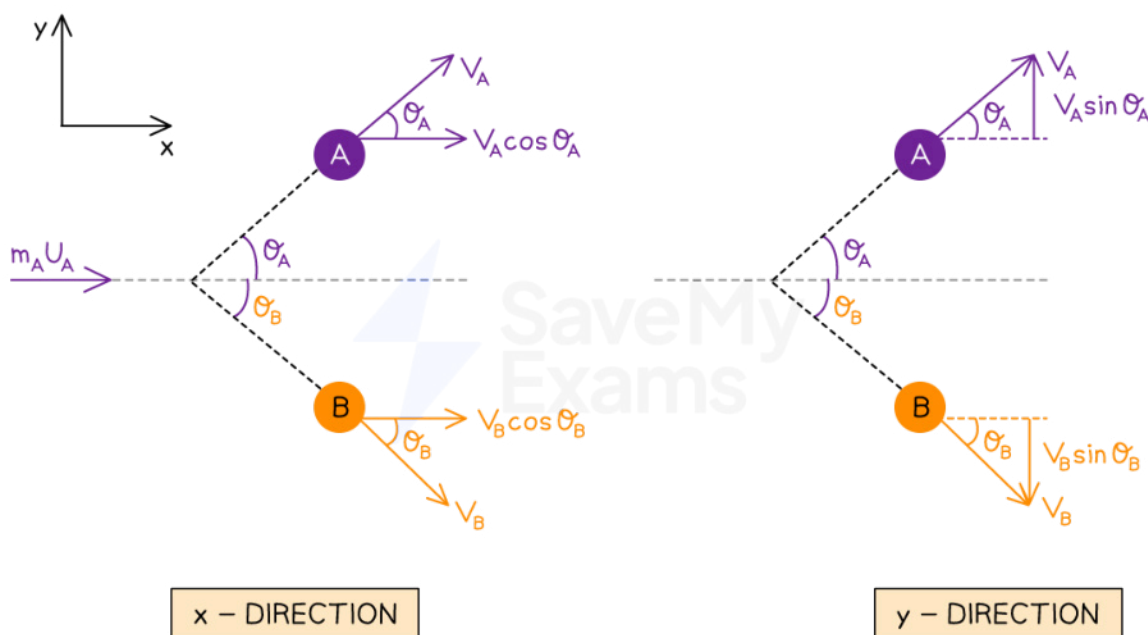

- Applying the **conservation of momentum** along the **x** direction gives

$$m_A u_A + 0 = m_A v_A \cos \theta_A + m_B v_B \cos \theta_B$$

- Applying the conservation of momentum along the **y** direction gives

$$0 + 0 = m_A v_A \sin \theta_A - m_B v_B \sin \theta_B$$

- The minus sign now comes from B moving **downwards**, whilst positive y is considered **upwards**
- The momentum **before** in the y direction is **0** for both balls A and B because B is stationary and A is **only** travelling in the **x** direction, so u_A has no vertical component
- Since there are two equations involving sine and cosine, it is helpful to remember the trigonometric identity:

$$\tan \theta = \frac{\sin \theta}{\cos \theta}$$

- When the collision is elastic, the conservation of linear momentum and energy indicates that $\theta_A + \theta_B = 90^\circ$



Your notes



Your notes

Worked example

A snooker ball of mass 0.15 kg collides with a stationary snooker ball of mass 0.35 kg. After the collision, the second snooker ball moves away with a speed of 0.48 m s^{-1} . The paths of the balls make angles of 43° and 47° with the original direction of the first snooker ball.

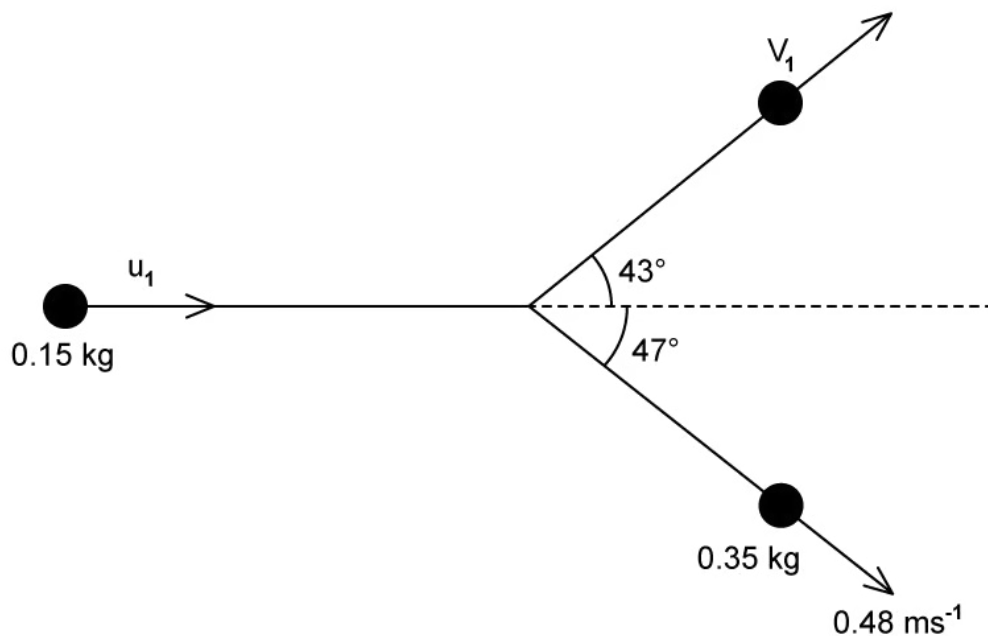

Calculate the speed u_1 and v_1 of the first snooker ball before and after the collision.

Answer

Step 1: List the known quantities

- Mass of the first snooker ball, $m_1 = 0.15 \text{ kg}$
- Mass of the second snooker ball, $m_2 = 0.35 \text{ kg}$
- Velocity of second ball after, $v_2 = 0.48 \text{ m s}^{-1}$
- Angle of the first ball, $\theta_1 = 43^\circ$
- Angle of the first ball, $\theta_2 = 47^\circ$

Step 2: State the equation for the conservation of momentum in the y (vertical) direction

$$0 = m_1 v_1 \sin \theta_1 - m_2 v_2 \sin \theta_2$$

Step 3: Calculate the speed of the first ball after the collision, v_1

- Use the conservation of momentum in the y direction to calculate the speed of the first snooker ball after the collision

$$m_1 v_1 \sin \theta_1 = m_2 v_2 \sin \theta_2$$

$$v_1 = \frac{m_2 v_2 \sin \theta_2}{m_1 \sin \theta_1}$$

$$v_1 = \frac{0.35 \times 0.48 \times \sin(47)}{0.15 \times \sin(43)} = 1.2 \text{ m s}^{-1}$$

Step 3: State the equation for the conservation of momentum in the x (horizontal) direction

$$m_1 u_1 = m_1 v_1 \cos \theta_1 + m_2 v_2 \cos \theta_2$$

Step 4: Calculate the speed of the first ball before the collision, u_1

$$u_1 = \frac{m_1 v_1 \cos \theta_1 + m_2 v_2 \cos \theta_2}{m_1}$$

$$u_1 = \frac{(0.15 \times 1.2 \times \cos(43)) + (0.35 \times 0.48 \times \cos(47))}{0.15} = 1.6 \text{ m s}^{-1}$$



Your notes



Your notes

Examiner Tip

Make sure you clearly label your diagram or write out the known quantities before you substitute values into the question. It's very easy to substitute in the incorrect velocity or mass. Use subscripts such as '1' '2' or 'A' 'B' depending on the question to help keep track of these.

Although you will get full marks either way, it may be easier in these equations to rearrange first and then substitute instead of the other way around, to keep track of the multiple masses and velocities.

Make sure your calculator is in degree mode if your angles are given in degrees!

If you use the fraction function to input your values, remember that you need to close the brackets on the trig functions or it will give you the wrong answer.

- Eg.
$$\frac{(0.35 \times 0.48 \times \sin(47))}{(0.15 \times \sin(43))} = 1.2 \text{ m s}^{-1}$$

And if you input the values into your calculator as numerator \div denominator, make sure you put brackets around the whole denominator.

- Eg. $Ans \div (0.15 \times \sin(43))$

The trig equation for $\tan\theta$ is also given on your data sheet under 'Mathematical equations', as well as that for resolving forces.



Your notes

Angular Velocity

Angular Velocity

Motion in a Straight Line

- When an object moves in a straight line at a constant speed its motion can be described as follows:
 - The object moves at a constant velocity, v
 - Constant velocity means zero acceleration, a
 - Newton's First Law of motion says the object will continue to travel in a straight line at a constant speed unless acted on by another force
 - Newton's Second Law of motion says that for zero acceleration there is no net or resultant force
- For example, an ice hockey puck moving across a flat frictionless ice rink

ICE PUCK WITH CENTRED HOOK



ICE PUCK MOVING ON
FRICTIONLESS SURFACE

PUCK MOVING WITH
CONSTANT VELOCITY, v

Copyright © Save My Exams. All Rights Reserved

An ice puck moving in a straight line

Motion in a Circle

- If one end of a string was attached to the puck, and the other attached to a fixed point, it would no longer travel in a straight line, it would begin to travel in a circle



Your notes

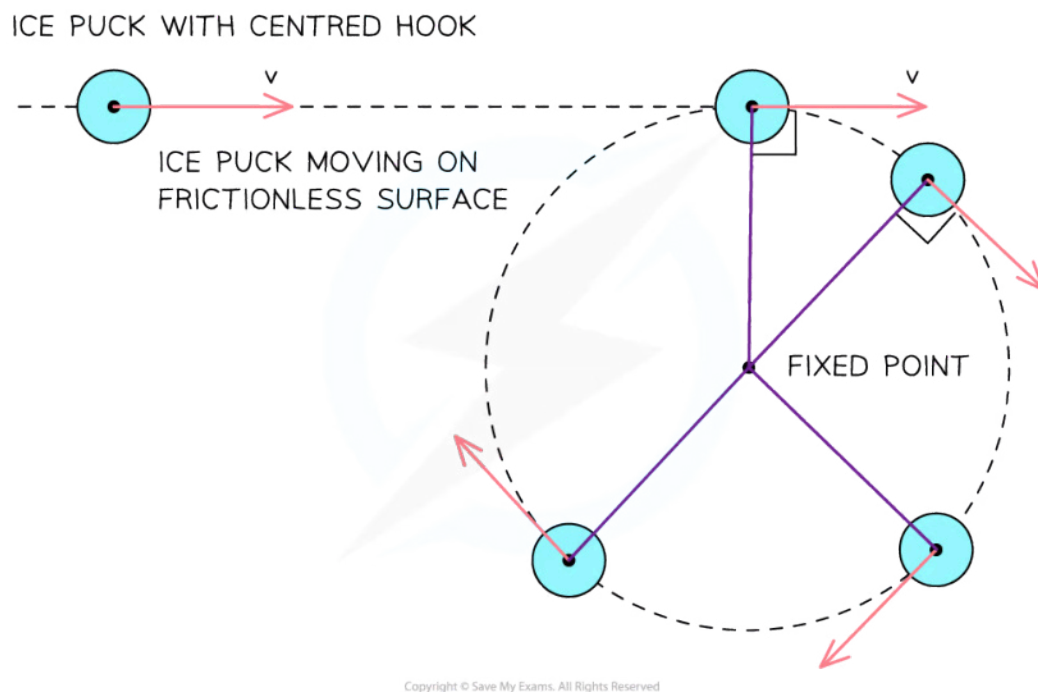

The red arrows represent the velocity vectors of the puck. If the string were cut, the puck would move off in the direction shown by the red vector, as predicted by Newton's first law.

- The motion of the puck can now be described as follows:
 - As the puck moves it stretches the string a little to a length r
 - The stretched string applies a force to the puck pulling it so that it moves in a circle of radius r around the fixed point
- The force acts at 90° to the velocity so there is no force component in the direction of velocity
 - As a result, the **magnitude** of the velocity is constant
 - However, the **direction** of the velocity **changes**
- As it starts to move in a circle the tension of the string continues to pull the puck at 90° to the velocity
 - The speed does not change, hence, this is called **uniform circular motion**

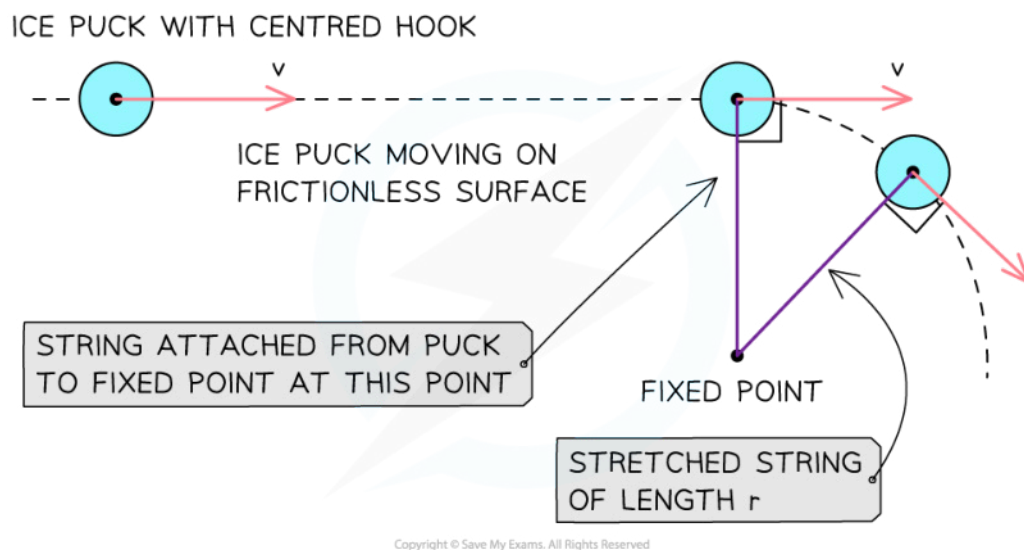

The applied force (tension) from the string causes the puck to move with uniform circular motion

Time Period & Frequency

- If the circle has a radius r , then the distance through which the puck moves as it completes one rotation is equal to the circumference of the circle = $2\pi r$
- The speed of the puck is therefore equal to:

$$\text{speed} = \frac{\text{distance travelled}}{\text{time taken}} = \frac{2\pi r}{T}$$

- Where:
 - r = the radius of the circle (m)
 - T = the time period (s)
- This is the same as the time period in waves and simple harmonic motion (SHM)
- The frequency, f , can be determined from the equation:

$$f = \frac{1}{T}$$

- Where:
 - f = frequency (Hz)
 - T = the time period (s)

Angles in Radians

- A **radian** (rad) is defined as:

The angle subtended at the centre of a circle by an arc equal in length to the radius of the circle



Your notes

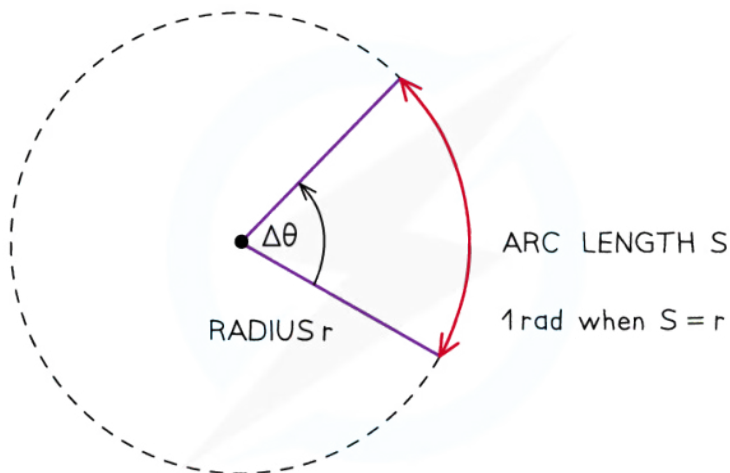

Copyright © Save My Exams. All Rights Reserved

When the angle is equal to one radian, the length of the arc (S) is equal to the radius (r) of the circle

- Radians are commonly written in terms of π
- The angle in radians for a complete circle (360°) is equal to:

$$\frac{\text{circumference of circle}}{\text{radius}} = \frac{2\pi r}{r} = 2\pi$$

- Use the following equation to convert from degrees to radians:

$$\theta^\circ \times \frac{\pi}{180} = \theta \text{ rad}$$

- Use the following equation to convert from radians to degrees:

$$\theta \text{ rad} \times \frac{180}{\pi} = \theta^\circ$$

Table of common degrees to radians conversions

Degrees (°)	Radians (rads)
360	2π
270	$\frac{3\pi}{2}$
180	π
90	$\frac{\pi}{2}$

Copyright © Save My Exams. All Rights Reserved

Angular Displacement

- In circular motion, it is more convenient to measure angular displacement in units of radians rather than units of degrees
- Angular displacement is defined as:

The change in angle, in radians, of a body as it rotates around a circle

- Where:
 - $\Delta\theta$ = angular displacement, or angle of rotation (radians)
 - S = length of the arc, or the distance travelled around the circle (m)
 - r = radius of the circle (m)

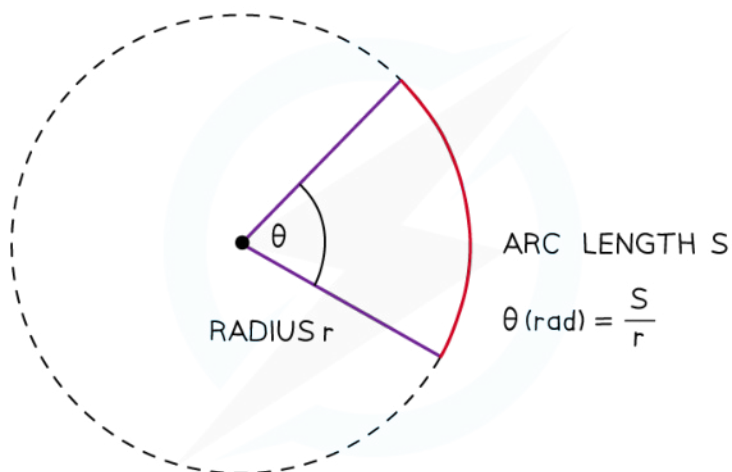

Copyright © Save My Exams. All Rights Reserved

An angle in radians, subtended at the centre of a circle, is the arc length divided by the radius of the circle



Your notes

Angular Speed

- Any object rotating with a uniform circular motion has a constant speed but constantly changing velocity
- Its velocity is changing so it is **accelerating**
 - But at the same time, it is moving at a constant speed
- The angular speed, ω , of a body in circular motion is defined as:

The change in angular displacement with respect to time
- Angular speed is a **scalar** quantity and is measured in rad s^{-1}
- The angular speed does not depend on the length of the line AB
- The line AB will sweep out an angle of 2π rad in a time T

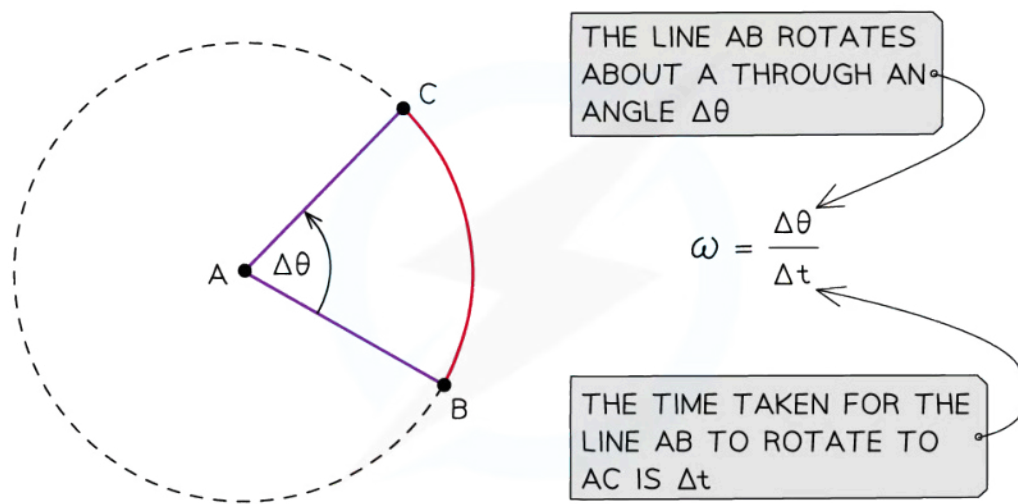

Copyright © Save My Exams. All Rights Reserved

The angular speed is ω is the rate at which the line AB rotates

Angular Velocity & Linear Speed

- Angular velocity is a **vector** quantity and is measured in rad s^{-1}
- Angular speed is the **magnitude** of the angular velocity
- Although the angular speed doesn't depend on the radius of the circle, the **linear speed does**



Your notes

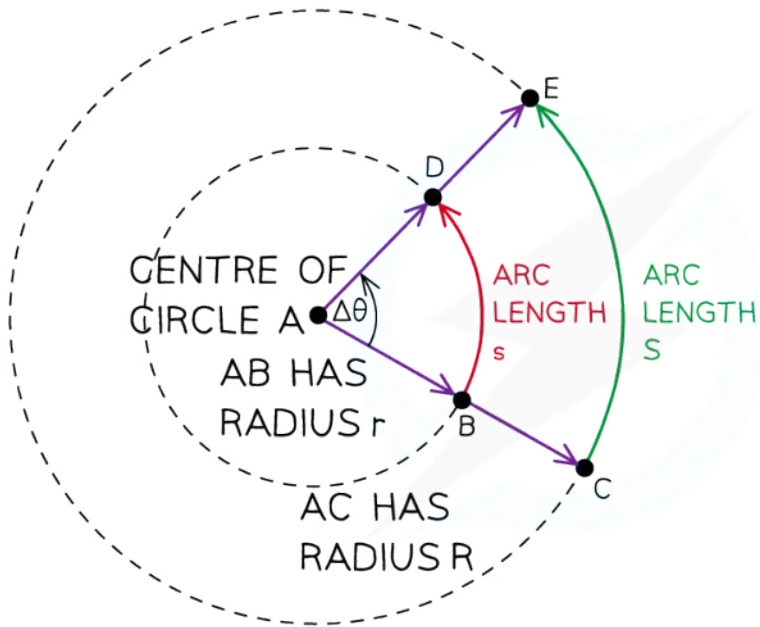

FOR THE CIRCLE OF RADIUS r

$$\Delta\theta = \frac{s}{r}$$

$$s = r \times \Delta\theta$$

$$\frac{s}{\Delta t} = r \times \frac{\Delta\theta}{\Delta t}$$

$$v = r \times \omega$$

FOR THE CIRCLE OF RADIUS R

$$\Delta\theta = \frac{S}{R}$$

$$S = R \times \Delta\theta$$

$$\frac{S}{\Delta t} = R \times \frac{\Delta\theta}{\Delta t}$$

$$V = R \times \omega$$

Copyright © Save My Exams. All Rights Reserved

The angle $\Delta\theta$ is swept out in a time Δt , but the arc lengths s and S are different and so are the linear speeds

- The linear speed, v , is related to the angular speed, ω , by the equation:

$$v = r\omega$$

- Where:

- v = linear speed (m s^{-1})
- r = radius of circle (m)
- ω = angular speed (rad s^{-1})

- Taking the angular displacement of a complete cycle as 2π , the angular speed ω can be calculated using the equation:

$$\omega = 2\pi f = \frac{2\pi}{T}$$

- Therefore, the linear velocity can also be written as:

$$v = \frac{2\pi r}{T}$$



Your notes

Worked example

Convert the following angular displacement into degrees:

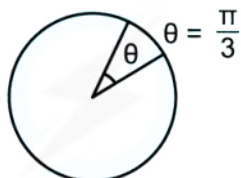

Copyright © Save My Exams. All Rights Reserved

STEP 1

REARRANGE DEGREES TO RADIANS CONVERSION EQUATION

$$\text{DEGREES} \rightarrow \text{RADIANS} \quad \theta^\circ \times \frac{\pi}{180} = \theta \text{ RAD}$$

$$\text{RADIANS} \rightarrow \text{DEGREES} \quad \theta \text{ RAD} \times \frac{180}{\pi} = \theta^\circ$$

STEP 2

SUBSTITUTE VALUE

$$\frac{\pi}{3} \text{ RAD} \times \frac{180}{\pi} = \frac{180^\circ}{3} = 60^\circ$$

π 's WILL CANCEL OUT

Copyright © Save My Exams. All Rights Reserved



Your notes

Worked example

A bird flies in a horizontal circle with an angular speed of 5.25 rad s^{-1} of radius 650 m.

Calculate:

- (a) The linear speed of the bird
- (b) The frequency of the bird flying in a complete circle

a) STEP 1

LINEAR SPEED EQUATION

$$v = r\omega$$

STEP 2

SUBSTITUTE IN VALUES

$$v = 650 \times 5.25 = 3412.5 = 3410 \text{ ms}^{-1} \quad (3 \text{ s.f.})$$

b) STEP 1

ANGULAR SPEED WITH FREQUENCY EQUATION

$$\omega = 2\pi f$$

STEP 2

REARRANGE FOR FREQUENCY

$$f = \frac{\omega}{2\pi}$$

STEP 3

SUBSTITUTE IN VALUES

$$f = \frac{5.25}{2\pi} = 0.83556\dots = 0.836 \text{ Hz} \quad (3 \text{ s.f.})$$

Copyright © Save My Exams. All Rights Reserved

Examiner Tip

Remember the units of angular velocity as rad s^{-1} , so any angles used in calculations must be in **radians** and **not** degrees!

T is the time period which is the time taken for **one full** revolution.



Your notes

Centripetal Force

Centripetal Force

- Velocity and acceleration are both vector quantities
- An object in uniform circular motion is **continuously changing direction**, and therefore is **constantly changing velocity**
 - The object must therefore be **accelerating**
- This is called the **centripetal acceleration** and is **perpendicular** to the direction of the linear speed
 - Centripetal means it acts **towards the centre** of the circular path
- From [Newton's second law](#), this must mean there is a resultant force acting upon it
 - This is known as the **centripetal force** and is what keeps the object moving in a circle
 - This means the object changes direction **even if** its magnitude of velocity remains constant
- The centripetal force (F) is defined as:

The resultant force perpendicular to the velocity required to keep a body in a uniform circular motion which acts towards the centre of the circle

- The magnitude of the centripetal force F can be calculated using:

$$F = \frac{mv^2}{r} = mr\omega^2$$

- Where:
 - F = centripetal force (N)
 - v = linear speed (m s^{-1})
 - ω = angular speed (rad s^{-1})
 - r = radius of the orbit (m)



Your notes

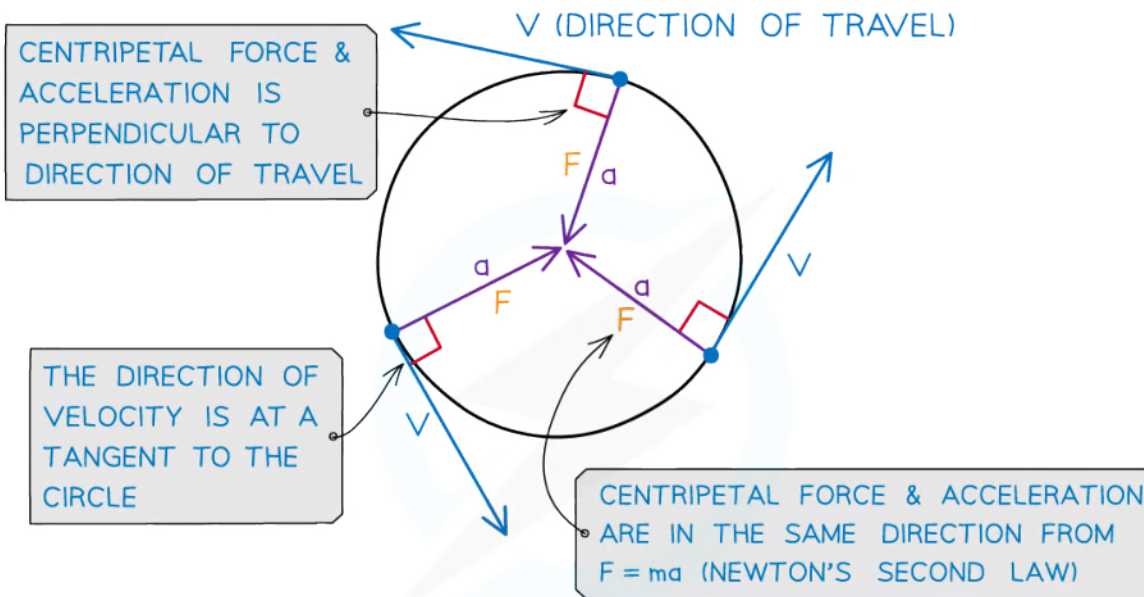

F = CENTRIPETAL FORCE

a = CENTRIPETAL ACCELERATION

V = DIRECTION OF VELOCITY = DIRECTION OF TRAVEL

Copyright © Save My Exams. All Rights Reserved

Centripetal force is always perpendicular to the linear velocity (i.e., the direction of travel)

- The direction of the centripetal force is:
 - In the **same** direction as the centripetal **acceleration** (towards the centre of the circle)
 - This is due to Newton's Second Law
 - **Perpendicular** to the linear **velocity**
- The centripetal force is **not** a separate force of its own
- It can be any type of force, depending on the situation, which keeps an object moving in a circular path
 - For example, tension, friction, gravitational, electrostatic or magnetic

Examples of centripetal force

Situation	Centripetal force
Car travelling around a roundabout	Friction between car tyres and the road
Ball attached to a rope moving in a circle	Tension in the rope
Earth orbiting the Sun	Gravitational force

Copyright © Save My Exams. All Rights Reserved

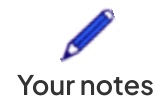

- When solving circular motion problems involving one of these forces, the equation for centripetal force can be equated to the relevant force equation
- For example, for a mass orbiting a planet in a circular path, the **centripetal force** is provided by the **gravitational force**
- When an object travels in circular motion, there is **no work done**
 - This is because there is **no** change in kinetic energy

Horizontal Circular Motion

- An example of horizontal circular motion is a vehicle driving on a curved road
- The forces acting on the vehicle are:
 - The **friction** between the tyres and the road
 - The **weight** of the vehicle downwards
- In this case, the centripetal force required to make this turn is provided by the frictional force
 - This is because the force of friction acts towards the centre of the circular path
- Since the centripetal force is provided by the force of friction, the following equation can be written:

$$\frac{mv^2}{r} = \mu mg$$

- Where:
 - m = mass of the vehicle (kg)
 - v = speed of the vehicle (m s^{-1})
 - r = radius of the circular path (m)
 - μ = static coefficient of friction
 - g = acceleration due to gravity (m s^{-2})



Your notes

- Rearranging this equation for v gives:

$$v^2 = \mu gr$$

$$v_{max} = \sqrt{\mu gr}$$

- This expression gives the maximum speed at which the vehicle can travel around the curved road without skidding
 - If the speed exceeds this, then the vehicle is likely to skid
 - This is because the centripetal force required to keep the car in a circular path could not be provided by friction, as it would be too large

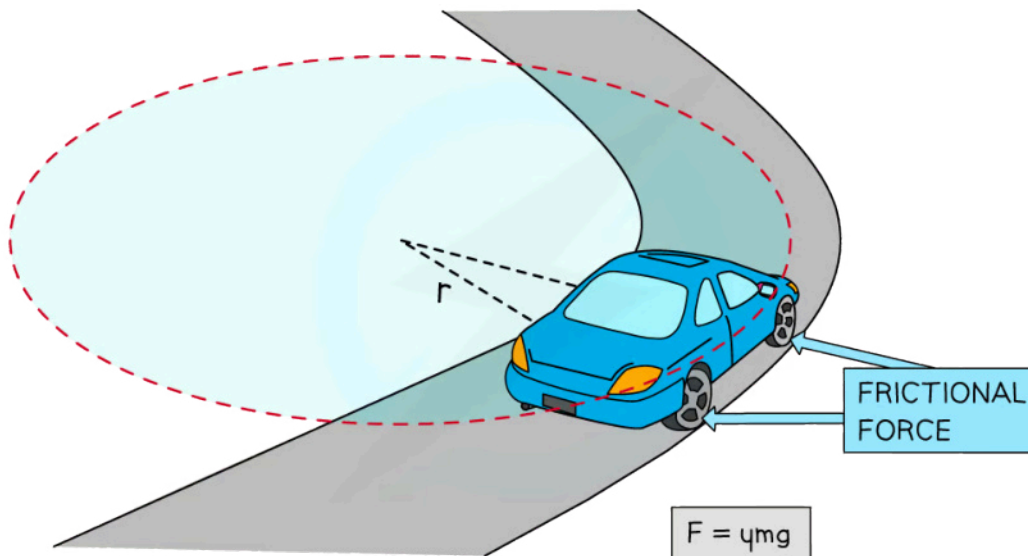

Copyright © Save My Exams. All Rights Reserved

The frictional force provides the centripetal force

- Therefore, in order for a vehicle to avoid skidding on a curved road of radius r , its speed must satisfy the equation

$$v < \sqrt{\mu gr}$$

- A mass attached to a string rotating around is another example of horizontal circular motion
- In this case, the **tension** is the **centripetal force** as it acts towards the centre of the circle
- This time, the weight of the mass will be acting as well as the tension of the string



Your notes

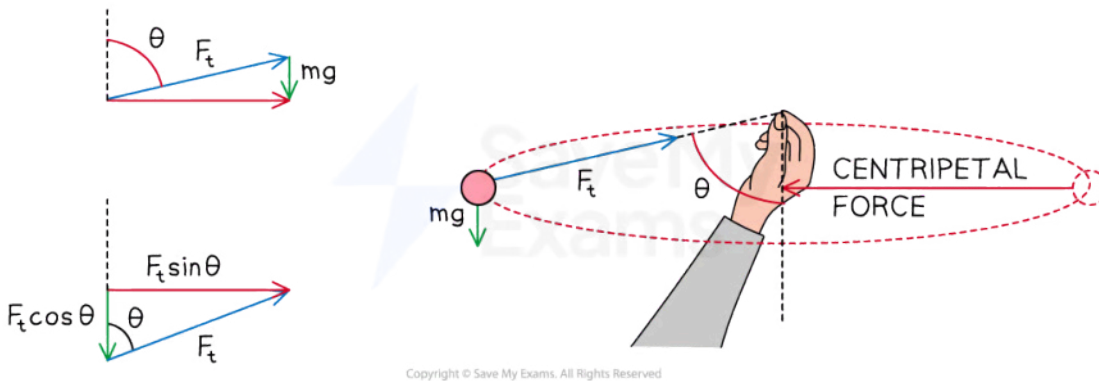

A mass attached to a string will have its weight acting meaning the string is at an angle

- The weight mg of the mass needs to be balanced by the **vertical** component of the tension

$$F_t \cos \theta = mg$$

- This means the string will always be at an **angle** and never perfectly horizontal
- The ball's linear velocity, v is still perpendicular to the tension and its weight, mg points **downward**
- All three forces are perpendicular to each other, so no other component contributes to the centripetal force, just the tension
- The centripetal force is still towards the centre of the circle, but now is just the **horizontal** component of the tension

$$F_t \sin \theta = \frac{mv^2}{r}$$

- This is an important example of resolving vectors properly. The vertical component does not always have ' $\sin \theta$ ', it depends on what θ is defined as

Banking

- A banked road, or track, is a curved surface where the outer edge is raised higher than the inner edge
 - The purpose of this is to make it safer for vehicles to travel on the curved road, or track, at a reasonable speed without skidding
- When a road is banked, the centripetal force no longer depends on the friction between the tyres and the road
- Instead, the centripetal force depends solely on the **horizontal component** of the **normal force**



Your notes

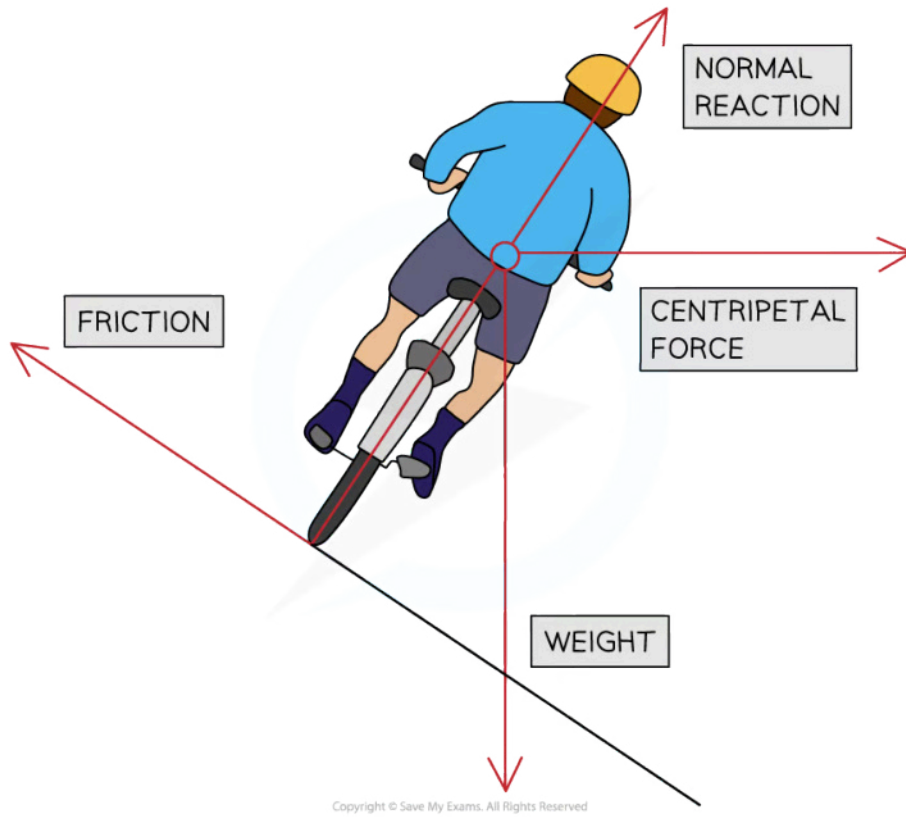

During banking, the horizontal component of the normal reaction force provides the centripetal force



Your notes

Worked example

A 300 g ball is made to travel in a circle of radius 0.8 m on the end of a string. If the maximum force the ball can withstand before breaking is 60 N, what is the maximum speed of the ball?

Answer:

Step 1: List the known quantities

- Mass, $m = 300 \text{ g} = 300 \times 10^{-3} \text{ kg}$
- Radius, $r = 0.8 \text{ m}$
- Resultant force, $F = 60 \text{ N}$

Step 2: Rearrange the centripetal force equation for v

$$F_{max} = \frac{mv_{max}^2}{r}$$

$$v_{max} = \sqrt{\frac{rF_{max}}{m}}$$

Step 3: Substitute in the values

$$v_{max} = \sqrt{\frac{0.8 \times 60}{300 \times 10^{-3}}} = 12.6 \text{ m s}^{-1}$$

Examiner Tip

The linear speed, v is sometimes referred to as the 'tangential' speed.

The centripetal force equation is not given in your data book, but you are given in the equations for centripetal acceleration. You just need to multiply them by mass m since the centripetal force $F = ma$.

It is important you understand the foundations of circular motion, especially how to use the equations. This will heavily link with kepler's laws and magnetic fields.



Your notes

Centripetal Acceleration

Calculating Centripetal Acceleration

- Centripetal acceleration is defined as:

The acceleration of an object towards the centre of a circle when an object is in motion (rotating) around a circle at a constant speed

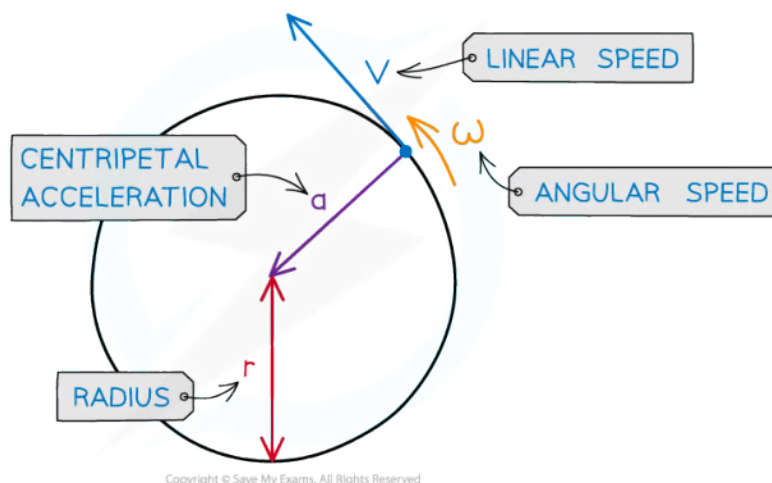

Copyright © Save My Exams. All Rights Reserved

Centripetal acceleration is always directed toward the centre of the circle, and is perpendicular to the object's velocity

- It is directed towards the centre of the circle as it is in the **same** direction as the centripetal force
- It can be defined using the radius r and linear speed v :

$$a = \frac{v^2}{r}$$

- Where:
 - a = centripetal acceleration (m s^{-2})
 - v = linear speed (m s^{-1})
 - r = radius of the circular orbit (m)
- Using the equation relating angular speed ω and linear speed v :

$$v = r\omega$$

- Where:
 - ω = angular speed (rad s^{-1})
- These equations can be combined to give another form of the centripetal acceleration equation:



Your notes

$$a = \omega^2 r$$

- Alternatively, since we know **angular velocity** is:

$$\omega = 2\pi f = \frac{2\pi}{T}$$

- Where:
 - f = frequency (Hz)
 - T = time period (s)
- This means the centripetal acceleration can also be written as:

$$a = \left(\frac{2\pi}{T}\right)^2 r = \frac{4\pi^2 r}{T^2}$$

- This equation shows how the centripetal acceleration relates to the linear speed and the angular speed

Worked example

A ball tied to a string is rotating in a horizontal circle with a radius of 1.5 m and an angular speed of 3.5 rad s⁻¹.

Calculate its centripetal acceleration if the radius was twice as large and angular speed was twice as fast.

STEP 1

ANGULAR ACCELERATION EQUATION WITH ANGULAR SPEED

$$a = r\omega^2$$

STEP 2

CHANGE IN ANGULAR ACCELERATION WITH TWICE THE RADIUS AND ANGULAR SPEED

$$a = (2r) \times (2\omega)^2 = 2r \times 4\omega^2 = 8r\omega^2$$

THE CENTRIPETAL ACCELERATION WILL BE 8x BIGGER

STEP 3

SUBSTITUTE IN VALUES OF RADIUS AND ANGULAR SPEED

$$a = 8r\omega^2 = 8 \times 1.5 \times 3.5^2 = 147 \text{ ms}^{-2}$$

Copyright © Save My Exams. All Rights Reserved

Examiner Tip

The equations for centripetal acceleration are given on your data sheet in multiple forms. Which form you use depends on what you're given in the question i.e. v or ω



Your notes

Non-Uniform Circular Motion

Non-Uniform Circular Motion

- Some bodies are in **non-uniform** circular motion
- This happens when there is a **changing resultant force** such as in a **vertical** circle
- An example of vertical circular motion is swinging a ball on a string in a vertical circle
- The forces acting on the ball are:
 - The **tension** in the string
 - The **weight** of the ball downwards
- As the ball moves around the circle, the **direction** of the tension will change continuously
- The **magnitude** of the tension will also vary continuously, reaching a **maximum** value at the **bottom** and a **minimum** value at the **top**
 - This is because the direction of the weight of the ball never changes, so the resultant force will vary depending on the position of the ball in the circle

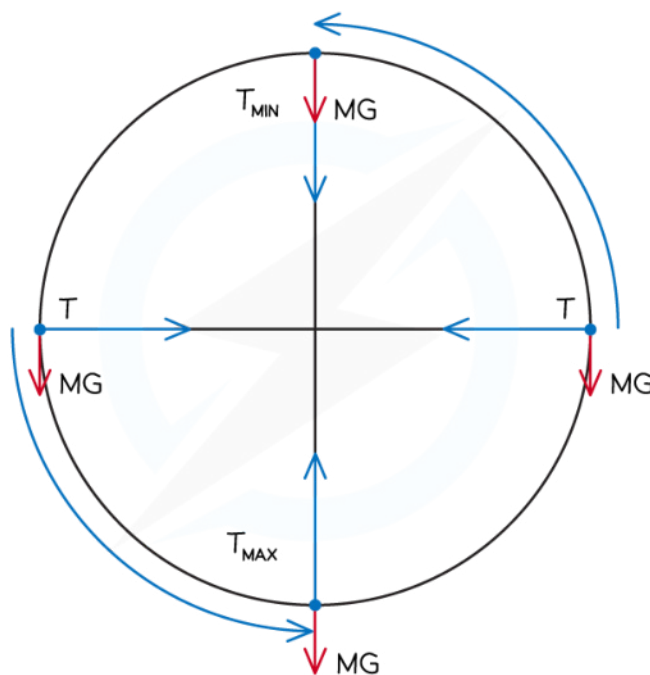

Copyright © Save My Exams. All Rights Reserved

- At the bottom of the circle, the tension must overcome the weight, this can be written as:

$$T_{max} = \frac{mv^2}{r} + mg$$

- As a result, the acceleration, and hence, the **speed** of the ball will be **slower** at the top

- At the top of the circle, the tension and weight act in the same direction, this can be written as:

$$T_{min} = \frac{mv^2}{r} - mg$$

- As a result, the acceleration, and hence, the **speed** of the ball will be **faster** at the bottom



Your notes



Your notes

Worked example

A bucket of mass 8.0 kg is filled with water and is attached to a string of length 0.5 m.

What is the minimum speed the bucket must have at the top of the circle so no water spills out?

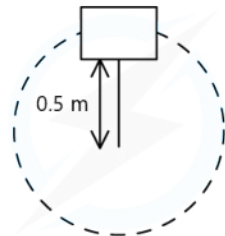

Copyright © Save My Exams. All Rights Reserved

Answer:

Step 1: Draw the forces on the bucket at the top



Copyright © Save My Exams. All Rights Reserved

- Although tension is in the rope, at the very top, the tension is 0

Step 2: Calculate the centripetal force

- The weight of the bucket = mg
- This is equal to the centripetal force since it is directed towards the centre of the circle

$$mg = \frac{mv^2}{r}$$

Step 3: Rearrange for velocity v

- m cancels from both sides

$$v = \sqrt{gr}$$

Step 4: Substitute in values

$$v = \sqrt{9.81 \times 0.5} = 2.21 \text{ m s}^{-1}$$



Your notes