



SL IB Chemistry



Your notes

Introduction to the Particulate Nature of Matter

Contents

- * Chemical Elements, Compounds & Mixtures
- * Separating Mixtures
- * Changes of State
- * Average Kinetic Energy



Your notes

Chemical Elements, Compounds & Mixtures

Elements, Compounds & Mixtures

- Elements are substances made from one kind of atom
- Compounds are made from two or more elements **chemically combined**
- Elements take part in chemical reactions in which new substances are made in processes that most often involve an energy change
- In these reactions, atoms combine together in **fixed ratios** that will give them full **outer shells** of electrons, producing **compounds**
- The properties of compounds can be quite different from the elements that form them

Elements into compounds diagram

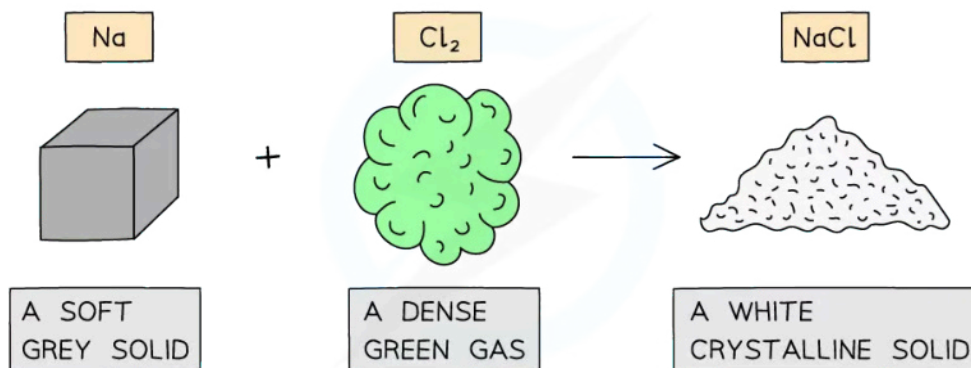

Copyright © Save My Exams. All Rights Reserved

The properties of sodium chloride are quite different from sodium and chlorine

- In a mixture, elements and compounds are interspersed with each other, but are **not** chemically combined
- This means the components of a mixture retain the **same** characteristic properties as when they are in their pure form
- So, for example, the gases nitrogen and oxygen when mixed in air, retain the same characteristic properties as they would have if they were separate
- Substances will burn in air because the oxygen present in the air supports **combustion**

Mixtures at the molecular level diagram

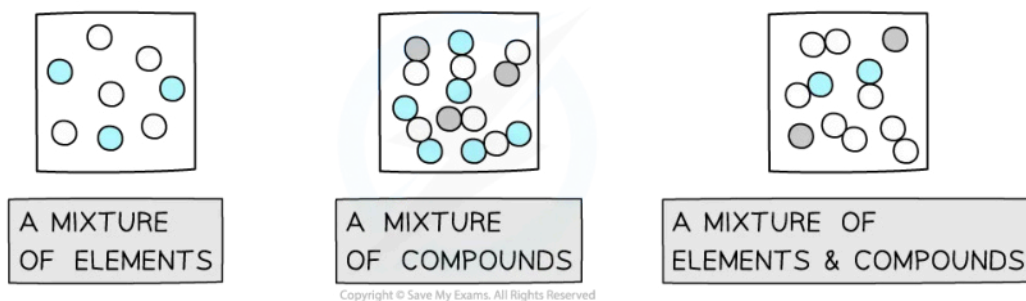

Particle in boxes diagrams such as these can help you to visualise the difference between elements and compounds at the molecular level

Homogeneous or heterogeneous

- A **homogeneous** mixture has uniform composition and properties throughout
- A **heterogeneous** mixture has non-uniform composition, so its properties are not the same throughout
- It is often possible to see the separate components in a **heterogeneous mixture**, but not in a **homogeneous mixture**

Types of Mixtures

Mixture	Homogeneous or Heterogeneous
Air	Homogeneous
Bronze (an alloy)	Homogeneous
Concrete	Heterogeneous
Orange juice with pulp	Heterogeneous

Separating Mixtures

- The components retain their individual properties in a mixture and we can often separate them relatively easily. The technique we choose to achieve this will take advantage of a suitable difference in the physical properties of the components

Some mixtures and examples of separation techniques

Mixture	What technique can be used to separate the components?	The property that is different in the components
Air	(Fractional) distillation	Boiling point
Salt & sand	Filtration	Solubility in water
Pigments in food colours	Chromatography	Adsorption on cellulose
An iron-sulfur mixture	A magnet	Magnetism



Your notes



Your notes

Separating Mixtures

Separating Mixtures

- The choice of the method of separation depends on the nature of the substances being separated
- All methods rely on there being a **difference** of some sort, usually in a physical property such as boiling point between the substances being separated

Separating a mixture of solids

- Differences in solubility can be used to separate solids
- For a difference in solubility, a suitable **solvent** must be chosen to ensure the desired substance only dissolves in it and not other substances or impurities, e.g. to separate a mixture of sand and salt, water is a suitable solvent to dissolve the salt, but not the sand

Solvation & Filtration

- Used to separate an **undissolved solid** from a mixture of the solid and a liquid / solution (e.g. sand from a mixture of sand and water). Centrifugation can also be used for this mixture
- Filter paper is placed in a filter funnel above another beaker
- The mixture of insoluble solid and liquid is poured into the filter funnel
- Filter paper will only allow small liquid particles to pass through in the filtrate
- Solid particles are too large to pass through the filter paper so will stay behind as a residue

Filtration Diagram



Your notes

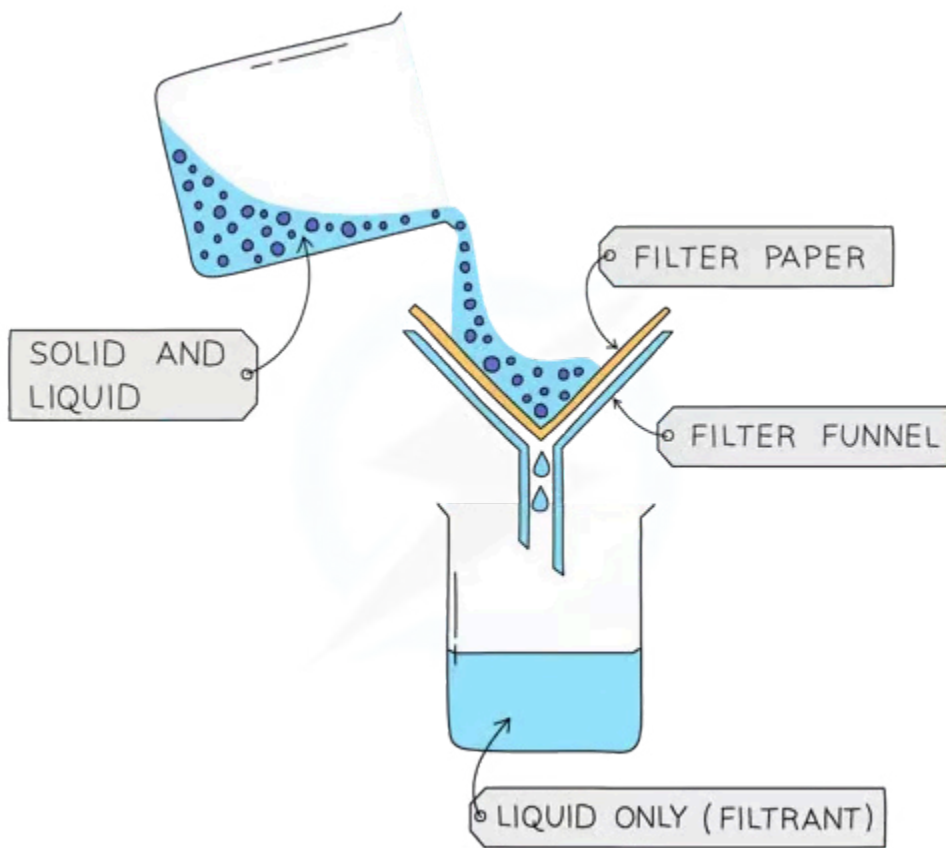

Copyright © Save My Exams. All Rights Reserved



Filtration enables the separation of insoluble solids from mixtures. The quality and speed of the filtration depends on the choice of filter paper and the size of the suspended solid particles. Vacuum filtration can be used for very finely suspended solids, which can clog up the pores in the filter paper using gravity filtration alone

Crystallisation

- Used to separate a **dissolved solid** from a solution, when the solid is more soluble in hot solvent than in cold (e.g. copper sulphate from a solution of copper (II) sulphate in water)
- The solution is heated, allowing the solvent to evaporate and leaving a saturated solution behind
- You can test if the solution is saturated by dipping a clean, dry, cold glass rod into the solution
 - If the solution is saturated, crystals will form on the glass rod when it is removed and allowed to cool
- The saturated solution is allowed to cool slowly and solids will come out of the solution as the solubility decreases, and crystals will grow
- Crystals are collected by filtering the solution

- They are then washed with distilled water to remove any impurities and then allowed to dry

Crystallisation Technique Diagram

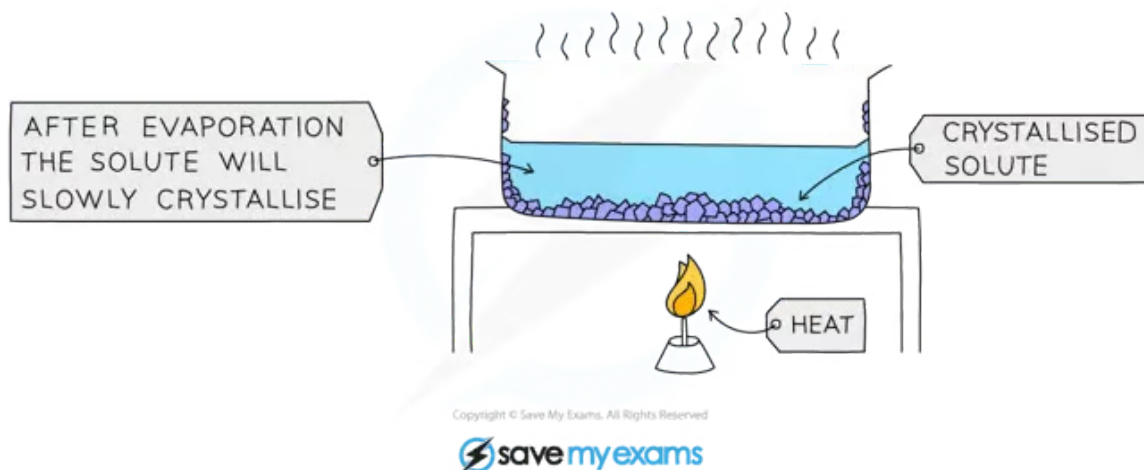

Crystallisation is carried out slowly using gentle heating or just leaving a saturated solution to evaporate so that larger crystals are formed which are easier to separate

Recrystallisation

- Recrystallisation is used to purify impure solids
- The principle is that a hot solvent is used to dissolve both the organic solid and the impurities and then as the solution cools the solid crystallises out and leaves behind the impurities in the solution
- The key is using the minimum amount of solvent to dissolve the solid and avoid loss of the product
- If any solid impurities remain in the solution, a hot filtration can be carried out
- Once the solution has cooled down to room temperature and crystallised then the product crystals can be recovered by filtration
- This is faster using Buchner apparatus in which filtration occurs under reduced pressure

Recrystallisation Equipment Diagram



Your notes



Your notes

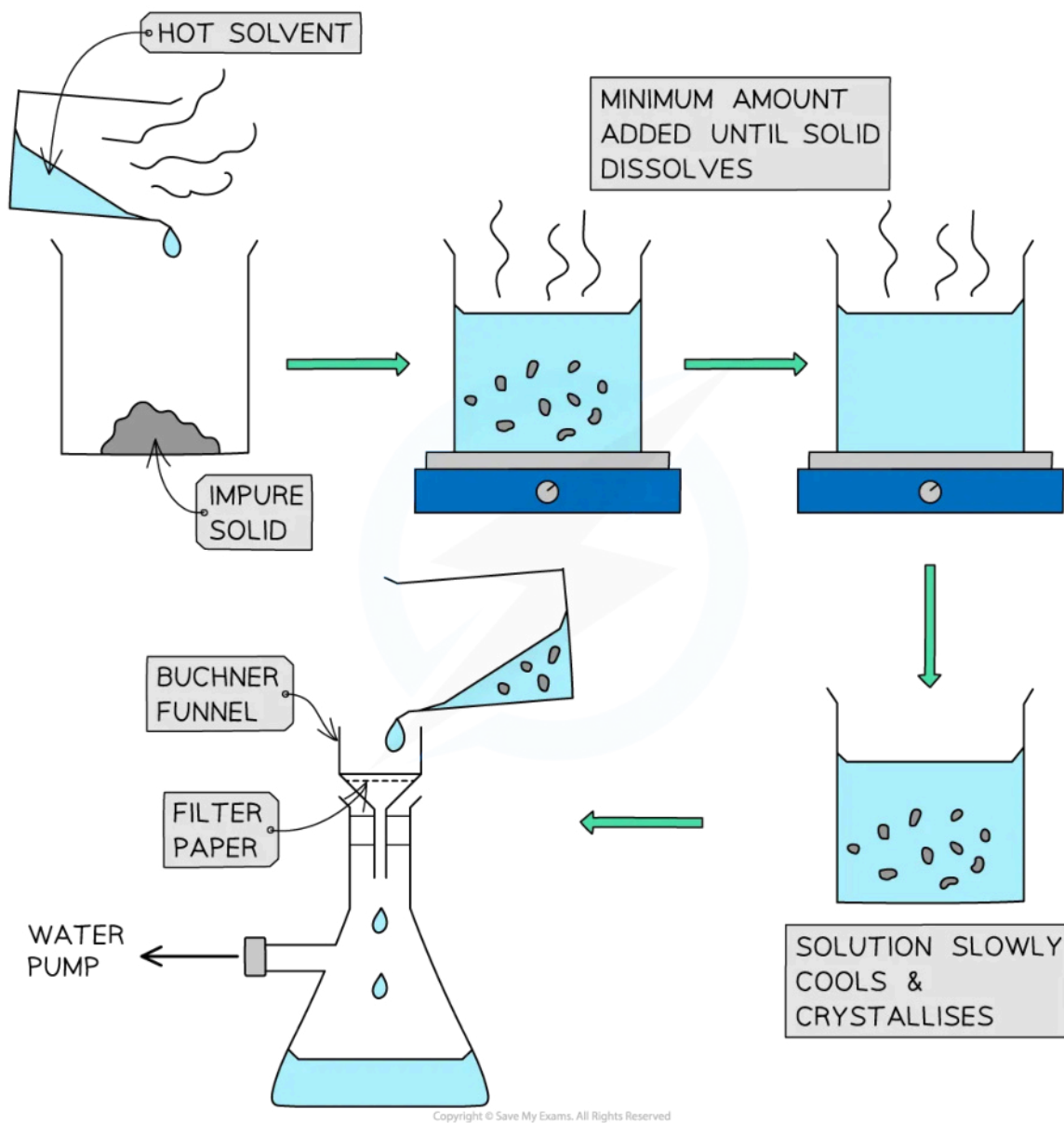

The steps involved in recrystallisation of an impure solid. After filtration the product is washed with fresh cold solvent and then allowed to dry on filter paper

Simple Distillation

- Used to separate a liquid and **soluble solid** from a solution (e.g. water from a solution of saltwater) or a pure liquid from a mixture of liquids
- The solution is heated and pure water evaporates producing a vapour which rises through the neck of the round-bottomed flask



Your notes

- The vapour passes through the condenser, where it cools and condenses, turning into pure water which is collected in a beaker
- After all the water is evaporated from the solution, only the solid solute will be left behind

Simple Distillation Diagram

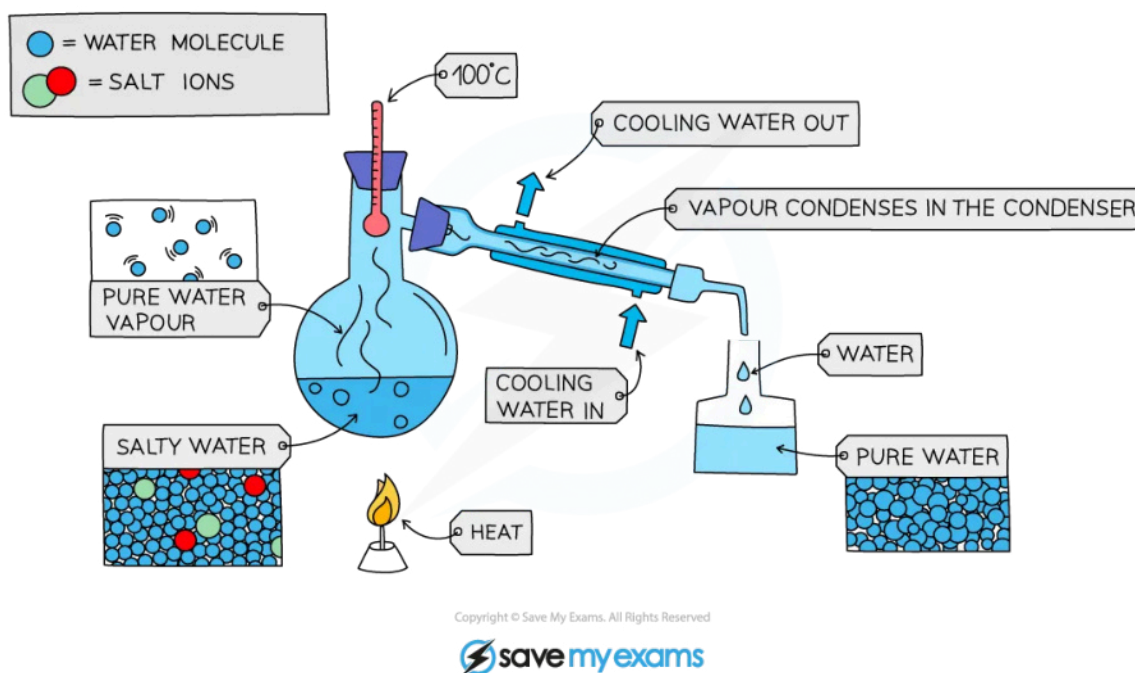

Simple distillation can be used to separate the products of fermentation, such as alcohol and water. However, more effective separation is to use fractional distillation where the liquids are closer to boiling point and a higher degree of purity is required

Fractional distillation

- Used to separate two or more liquids that are miscible with one another (e.g. ethanol and water from a mixture of the two)
- The solution is heated to the temperature of the substance with the lowest boiling point
- This substance will rise and evaporate first, and vapours will pass through a condenser, where they cool and condense, turning into a liquid that will be collected in a beaker
- All of the substance is evaporated and collected, leaving behind the other component(s) of the mixture
- For water and ethanol: ethanol has a boiling point of 78 °C and water of 100 °C. The mixture is heated until it reaches 78 °C, at which point the ethanol boils and distills out of the mixture and condenses into the beaker
- When the temperature starts to increase to 100 °C heating should be stopped. Water and ethanol are now separated

Fractional Distillation Diagram

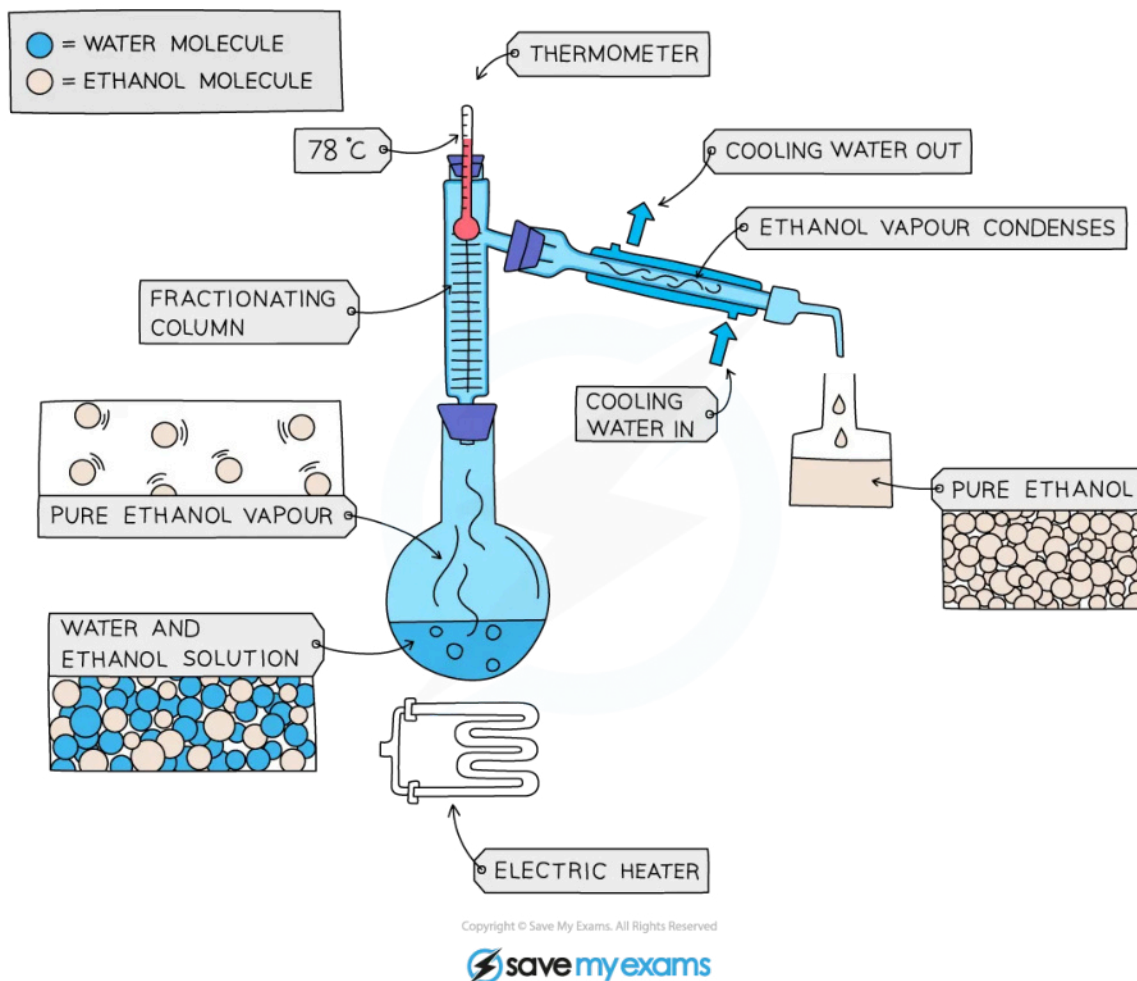

Separation of a mixture of ethanol and water is best achieved by fractional distillation when the two components are close together in boiling point or there are multiple components

- An electric heater is safer to use when there are flammable liquids present
- The separation of the components in petroleum is achieved by fractional distillation on an industrial scale
- Fractional distillation of crude oil is not carried out in school laboratories due to the toxic nature of some of the components of the crude oil, but it can sometimes be simulated using a synthetic crude oil made specially for the demonstration

Paper Chromatography

- This technique is used to separate substances that have **different solubilities** in a given solvent (e.g. different coloured inks that have been mixed to make black ink)

- A **pencil line** is drawn on chromatography paper and spots of the sample are placed on it. Pencil is used for this as ink would run into the chromatogram along with the samples
- The paper is then lowered into the solvent container, making sure that the pencil line sits **above** the level of the solvent so the samples don't wash into the solvent container
- The solvent travels up the paper by capillary action, taking some of the coloured substances with it
- This will show the different components of the ink / dye

Paper Chromatography Equipment Diagram



Your notes



Your notes

1 SET UP CHROMATOGRAPHY PAPER AS SHOWN

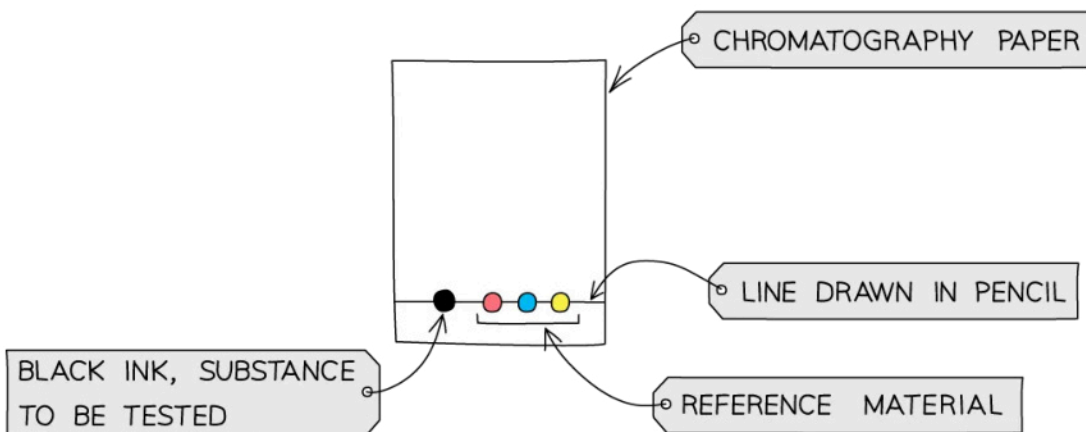

2 LOWER PAPER INTO A BEAKER WITH APPROPRIATE SOLVENT. WAIT FOR SOLVENT TO TRAVEL UP THE PAPER.

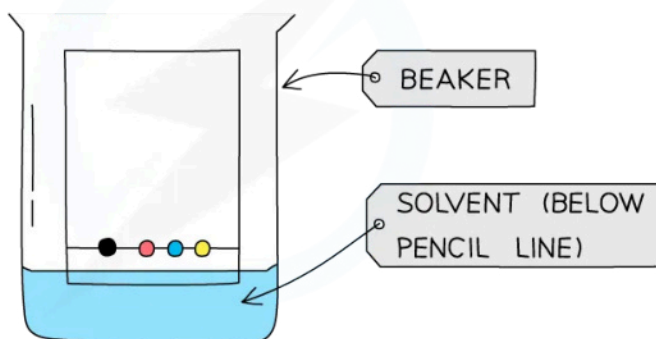

3 ANALYSE CHROMATOGRAM



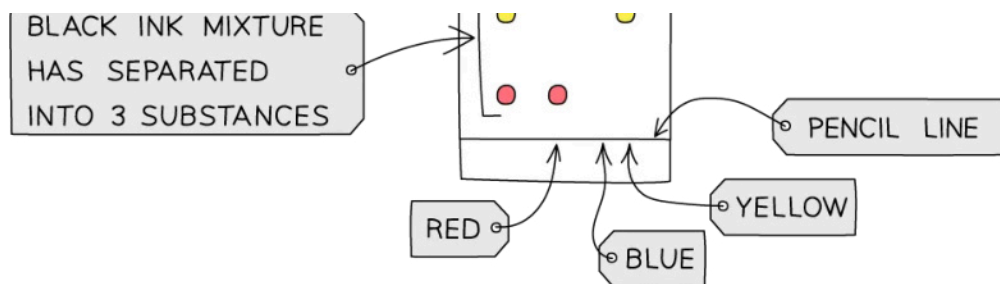

Copyright © Save My Exams. All Rights Reserved



Your notes

Analysis of the composition of ink can be carried out using paper chromatography. Different substances have different solubilities so will travel at different rates, causing the substances to spread apart. Those substances with higher solubility will travel further than the others



Your notes

Changes of State

The Kinetic Molecular Theory

What are the Three States of Matter?

Solids

- Solids have a **fixed** volume and shape and they have a high density
- The atoms **vibrate** in position but can't change location
- The particles are packed very closely together in a fixed and **regular pattern**

Liquids

- Liquids also have a fixed volume but adopt the shape of the container
- They are generally less dense than solids (an exception is water), but much denser than gases
- The particles **move** and **slide** past each other which is why liquids adopt the shape of the container and also why they are able to flow freely

Gases

- Gases do not have a fixed volume, and, like liquids, take up the shape of the container, but they fill the whole container
- Gases have a very low density
- Since there is a lot of space between the particles, gases can be **compressed** into a much smaller volume
- The particles are far apart and move randomly and quickly (around 500 m/s) in all directions
- They **collide** with each other and with the sides of the container (this is how **pressure** is created inside a can of gas)

Particle Arrangements in the Three States of Matter

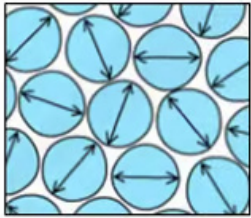
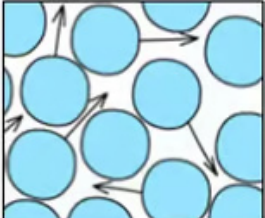
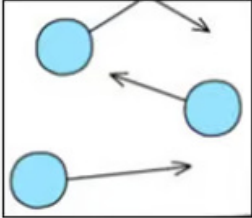
State	Solid	Liquid	Gas
Density	High	Medium	Low
Arrangement of particles	Regular pattern	Randomly arranged	Randomly arranged
Movement of particles	Vibrate around a fixed position	Move around each other	Move quickly in all directions
Energy of particles	Low energy	Greater energy	Highest energy
2D Diagram			



Your notes

- Changes of state are **physical changes** that are reversible
- These changes do not change the chemical properties or chemical makeup of the substances involved
- Vaporisation** includes **evaporation** and **boiling**
- Evaporation** involves the change of liquid to gas, but unlike boiling, **evaporation** occurs only at the surface and takes place at temperatures below the **boiling point**
- Boiling** occurs at a specific temperature and takes place when the **vapour pressure** reaches the external atmospheric pressure

Changes of State Diagram

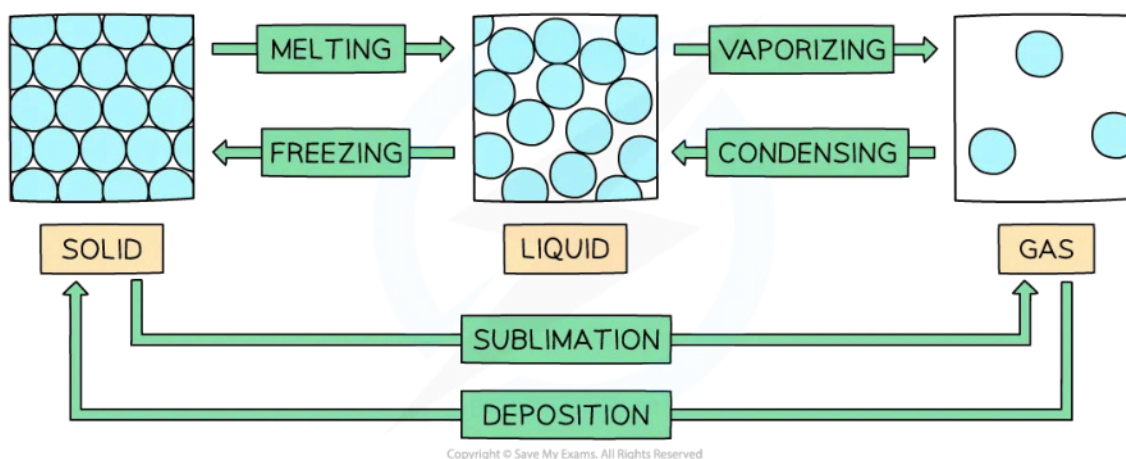

State changes and their interconversions can be represented using particle diagrams which help to emphasise the spacing and order of the particles. Energy is increasing left to right across this diagram

- When writing and balancing chemical equations sometimes it is necessary to represent the physical states of substances using the four **state symbols**
- In exams it is usually indicated where marks are awarded for this
- State symbols are essential in equations that represent defined thermodynamic conditions such as equations for ionisation energy, lattice enthalpy and enthalpy of formation

Examiner Tip

Be careful to match the bond breaking or bond making processes to the flow of energy during state changes.

Remember: To **break** bonds, energy is always **needed** to overcome the **forces of attraction** between the particles



Your notes

Average Kinetic Energy

Temperature & Average Kinetic Energy

- The relationship between temperature and kinetic energy during state changes can be represented graphically using the following sketch graph

Change of State Graph

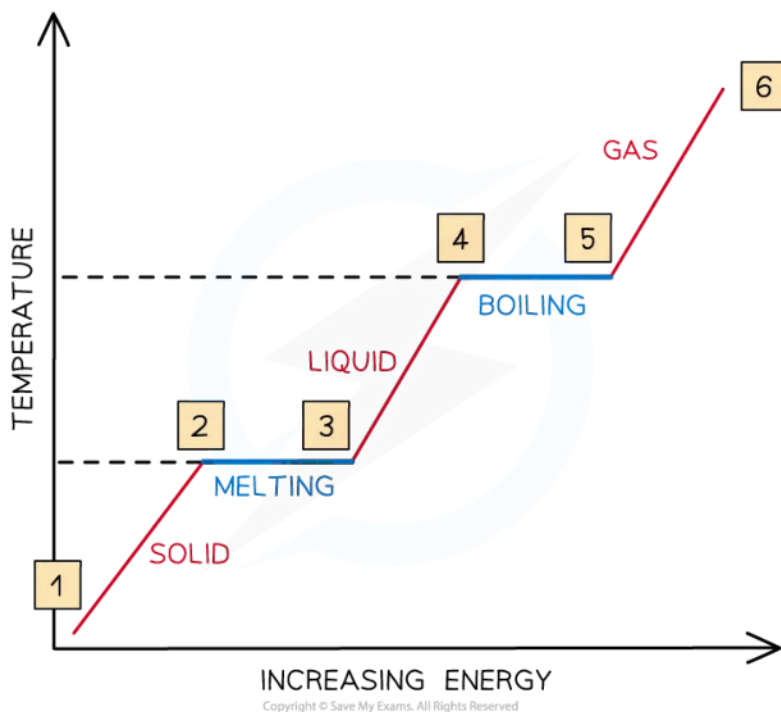

The relationship between temperature and energy during state changes

How to explain the energy changes during a state change?

- Between 1 & 2, the particles are vibrating and gaining **kinetic energy** and the temperature rises
- Between 2 & 3, all the energy goes into breaking bonds – there is **no** increase in **kinetic energy** or **temperature**
- Between 3 & 4, the particles are moving around and gaining in **kinetic energy**
- Between 4 & 5, the substance is boiling, so bonds are breaking and there is **no** increase in **kinetic energy** or **temperature**
- From 5 & 6, the particles are moving around rapidly and increasing in **kinetic energy**



Worked example

Which of these gases has the highest average kinetic energy?

N_2 at $150\text{ }^\circ\text{C}$

H_2 at $250\text{ }^\circ\text{C}$

Ar at $350\text{ }^\circ\text{C}$

Cl_2 at $250\text{ }^\circ\text{C}$

Answer

Argon, Ar, is the substance with the highest temperature so its particles have the highest average kinetic energy.

Converting between Celsius and Kelvin

- The kelvin (K) is the SI unit of temperature and has the same incremental value as the Celsius degree ($^\circ\text{C}$)
- The kelvin scale is known as absolute temperature and the kinetic energy of the particles is directly proportional to their temperature in kelvin
- The lowest possible temperature is absolute zero, equal to 0 K or $-273.15\text{ }^\circ\text{C}$
- This is the temperature at which the atoms and molecules in all substances have zero kinetic and potential energy

Temperature can be converted from Celsius to kelvin by adding 273:

$$\text{Temperature in K} = \text{Temperature in } ^\circ\text{C} + 273$$

$$\text{Temperature in } ^\circ\text{C} = \text{Temperature in K} - 273$$

Conversion chart between temperature scales in Kelvin and Celsius

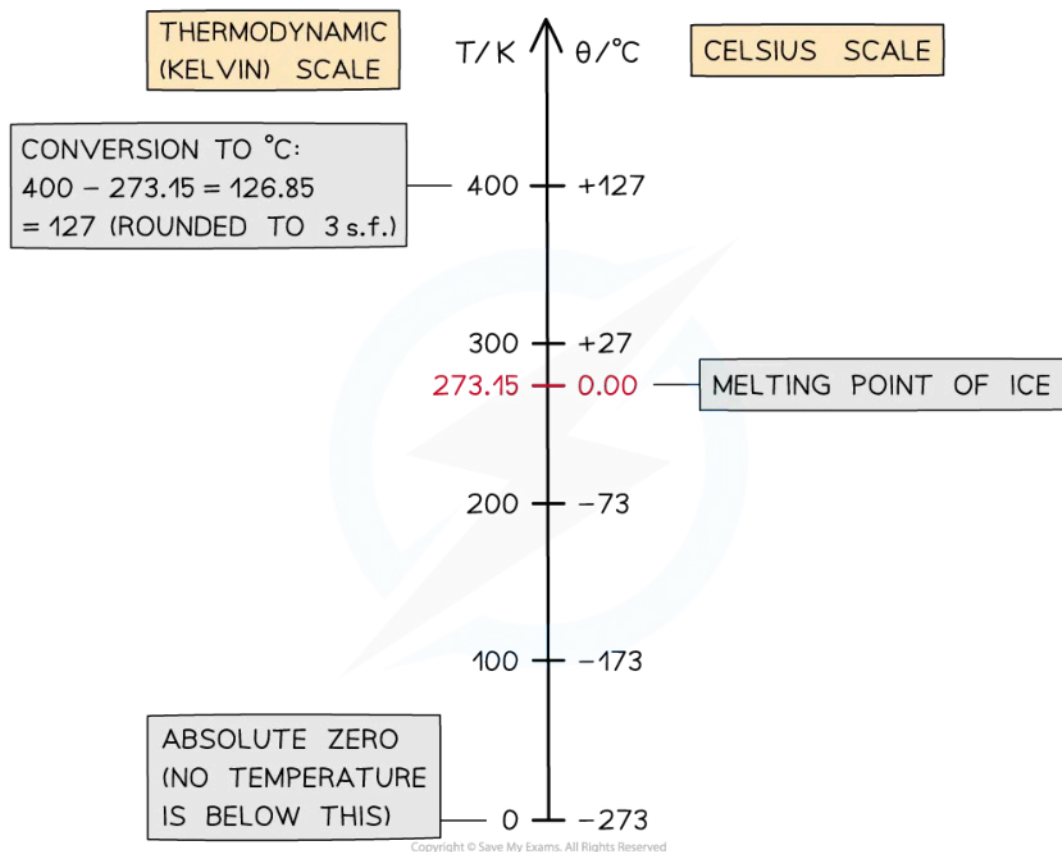

A change in a temperature of 1 K is equal to a change in temperature of 1 °C

Worked example

In many ideal gas problems, room temperature is considered to be 300 K.

What is this temperature in degrees Celsius?

Answer:

Step 1: Recall the kelvin to Celsius conversion

$$\theta / ^\circ\text{C} = T / \text{K} - 273$$

Step 2: Substitute in the value of 300 K

$$300 \text{ K} - 273 = 27 ^\circ\text{C}$$

 **Examiner Tip**

Students often confuse kinetic energy with the temperature of particles and assume that all particles at the same temperature have the same velocity. Particles of a substance at the same temperature have the same **average** kinetic energy, but some particles will move faster and some slower than the average.

Particles of different substances at the same temperature will diffuse at different speeds because they have different masses. The kinetic energy is governed by the relationship:

$$E_k = \frac{1}{2}mv^2$$

where E_k is the kinetic energy, m is the mass and v is the velocity of the particle



Your notes