



HL IB Physics

Your notes

Fission

Contents

- * Spontaneous & Induced Fission
- * Energy Released in Fission Reactions
- * Chain Reactions from Fission
- * Operation of a Nuclear Reactor
- * Radioactive Waste Management



Your notes

Spontaneous & Induced Fission

Spontaneous & Induced Fission

- There is a lot of energy stored within the nucleus of an atom
 - This energy can be released in a nuclear reaction such as **fission** or **fusion**
- Nuclear fission is defined as:

The splitting of a large, unstable nucleus into two smaller nuclei
- Isotopes of **uranium** and **plutonium** both undergo fission and are used as fuels in nuclear power stations to convert nuclear energy into electrical energy
- During fission, when a neutron collides with an unstable nucleus, the nucleus splits into **two smaller nuclei** (called daughter nuclei) as well as **two or three neutrons**
 - Gamma rays are also emitted

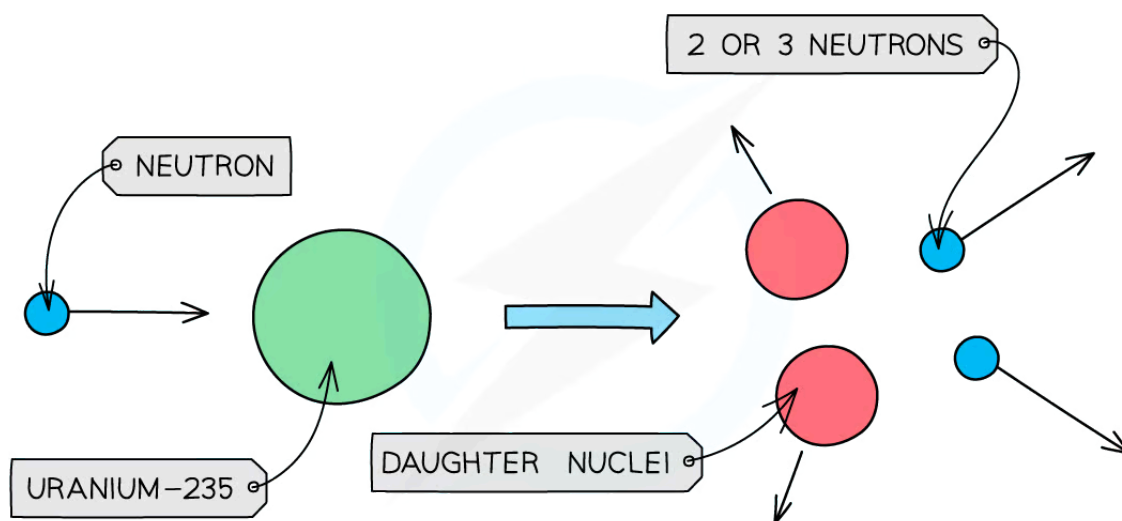

Copyright © Save My Exams. All Rights Reserved



Large nuclei can decay by fission to produce smaller nuclei and neutrons with a lot of kinetic energy

- The products of fission move away very **quickly**
- This is because energy is transferred from the **nuclear potential energy** store of a nucleus to the **kinetic energy** store of the fission fragments
 - This energy is then carried away as **heat**

Spontaneous Fission

- It is **rare** for nuclei to undergo fission without additional energy being put into the nucleus
- When nuclear fission occurs in this way it is called **spontaneous fission**



Your notes

Induced Fission

- Usually, for fission to occur the unstable nucleus must first **absorb** a **neutron**
 - This will be slow moving, often called a 'thermal' neutron
- Take, for example, uranium-235, which is commonly used as a fuel in nuclear reactors
- It has a very long half-life of 700 million years
- This means that it would have low activity and energy would be released only if it was to have additional neutrons added

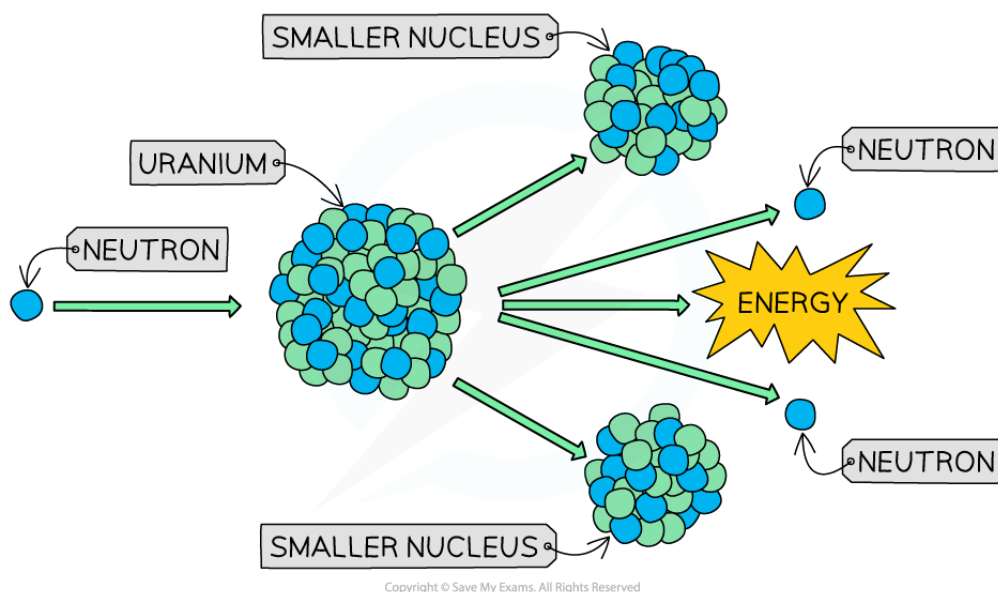

- During induced fission, a **neutron** is absorbed by the uranium-235 nucleus to make uranium-236
 - This is very unstable and splits by nuclear fission almost immediately

Worked example

During a particular spontaneous fission reaction, plutonium-239 splits as shown in the equation below:

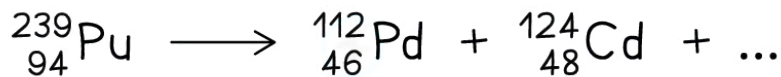

Copyright © Save My Exams. All Rights Reserved

Which answer shows the section missing from this equation?

A	${}_{0}^{3}\text{n}$
B	${}_{0}^{0}\gamma$
C	${}_{2}^{4}\alpha$
D	$3{}_{0}^{1}\text{n}$

Copyright © Save My Exams. All Rights Reserved

ANSWER: D

Step 1: Identify the different mass and atomic numbers

- Pu (Plutonium) has mass number 239 and atomic number 94
- Pd (Palladium) has mass number 112 and atomic number 46
- Cd (Cadmium) has mass number 124 and atomic number 48

Step 2: Calculate the mass and atomic number of the missing section

- Mass number is equal to the difference between the mass numbers of the reactants and the products

$$239 - (112 + 124) = 3$$

- Atomic number is equal to the difference between the atomic numbers of the reactants and the products

$$94 - (46 + 48) = 0$$

- The answer is therefore not **B** or **C**

Step 3: Determine the correct notation

- Neutrons have a mass number of 1
- The answer is therefore not **A**

- Therefore, this must be three neutrons, which corresponds to D



Your notes



Your notes

Energy Released in Fission Reactions

Energy Released in Fission Reactions

- When a large (parent) nucleus, such as uranium-235, undergoes a fission reaction, the daughter nuclei produced as a result will have a **higher binding energy per nucleon** than the parent nucleus
- As a result of the mass defect between the parent nucleus and the daughter nuclei, **energy is released**

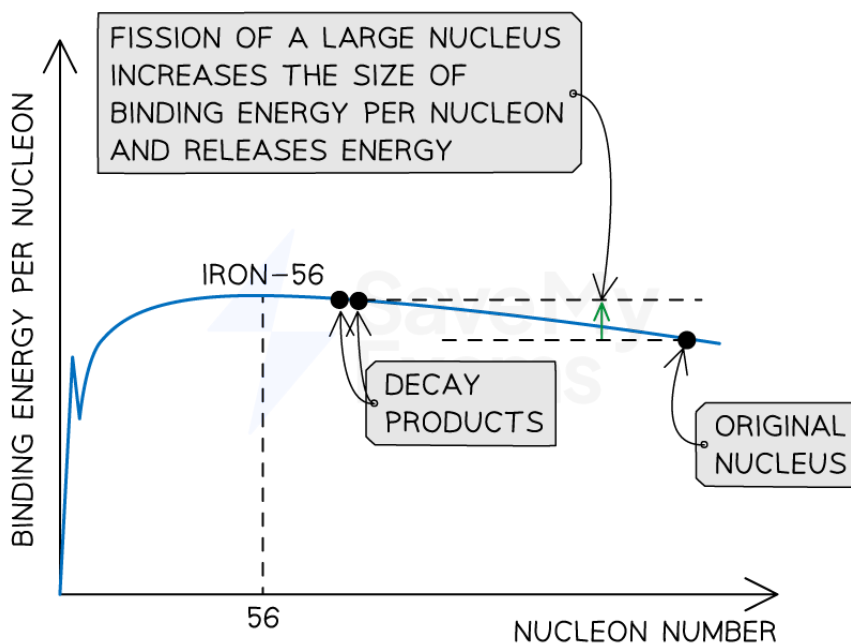

Copyright © Save My Exams. All Rights Reserved

Energy can be extracted from fission reactions due to the mass defect between parent and daughter nuclei

- Nuclear fission is well-regarded as having the fuel source with the **highest energy density** of any fuel that is currently available to us (until fusion reactions become feasible)

Examples of Common Fuels: Energy Density and Specific Energy Table



Your notes

Fuel	Specific energy (MJ kg ⁻¹)	Energy density (MJ m ⁻³)
Coal	35	2 × 10 ⁴
Hydrogen	130	10
Kerosene	48	3.3 × 10 ⁴
Gasoline (petrol)	45	3.4 × 10 ⁴
Wood	15.5	1 × 10 ⁴
Uranium-235 (fission)	7.5 × 10 ⁷	4 × 10 ¹³

Copyright © Save My Exams. All Rights Reserved

- Calculations involving energy released in fission reactions often require the use of equations found in an array of previous topics, such as

$$\text{density (kg m}^{-3}\text{)} = \frac{\text{energy density (J m}^{-3}\text{)}}{\text{specific energy (J kg}^{-1}\text{)}}$$

$$\text{no. of atoms} = \frac{\text{mass (g)} \times \text{Avogadro's number } N_A \text{ (mol}^{-1}\text{)}}{\text{molar mass (g mol}^{-1}\text{)}}$$



Your notes

Worked example

When a uranium-235 nucleus absorbs a slow-moving neutron and undergoes a fission reaction, one possible pair of fission fragments is technetium-112 and indium-122.

The equation for this process, and the binding energy per nucleon for each isotope, are shown below.

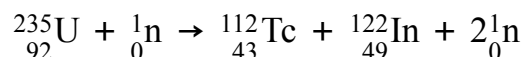

nucleus	binding energy per nucleon / MeV
${}_{92}^{235}\text{U}$	7.59
${}_{43}^{112}\text{Tc}$	8.36
${}_{49}^{122}\text{In}$	8.51

- Calculate the energy released per fission of uranium-235, in MeV.
- Determine the mass of uranium-235 required per day to run a 500 MW power plant at 35% efficiency.
- The specific energy of coal is approximately 35 MJ kg^{-1} .

For the same power plant, estimate the ratio

$$\frac{\text{mass of coal required per day}}{\text{mass of } {}^{235}\text{U required per day}}$$

Answer:

- (a) Energy released per fission of uranium-235

Step 1: Determine the binding energies of the nuclei before and after the reaction

- Binding energy is equal to binding energy per nucleon \times mass number
- Binding energy before (${}^{235}\text{U}$) = $235 \times 7.59 = 1784 \text{ MeV}$
- Binding energy after (${}^{112}\text{Tc} + {}^{122}\text{In}$) = $(112 \times 8.36) + (122 \times 8.51) = 1975 \text{ MeV}$

Step 2: Find the difference to obtain the energy released per fission reaction

- Therefore, the energy released per fission = $1975 - 1784 = 191 \text{ MeV}$



Your notes

(b) Mass of uranium-235 required per day

Step 1: List the known quantities

- Avogadro's number, $N_A = 6.02 \times 10^{23} \text{ mol}^{-1}$
- Molar mass of U-235, $m_r = 235 \text{ g mol}^{-1}$
- Power output, $P_{out} = 500 \text{ MW} = 500 \times 10^6 \text{ J s}^{-1}$
- Efficiency, $e = 35\% = 0.35$
- Time, $t = 1 \text{ day} = 60 \times 60 \times 24 = 86\,400 \text{ s}$

Step 2: Determine the number of atoms in 1 kg of U-235

- There are N_A (Avogadro's number) atoms in 1 mol of U-235, which is equal to a mass of 235 g

$$\text{number of atoms} = \frac{\text{mass (g)} \times N_A \text{ (mol}^{-1}\text{)}}{m_r \text{ (g mol}^{-1}\text{)}}$$

- A mass of 1 kg (1000 g) of U-235 contains $\frac{1000 \times (6.02 \times 10^{23})}{235} = 2.562 \times 10^{24} \text{ atoms kg}^{-1}$

Step 3: Determine the specific energy of U-235

- Specific energy of U-235 = total amount of energy released by 1 kg of U-235
- Specific energy of U-235 = (number of atoms per kg) \times (energy released per atom) = energy released per kg
- Energy released per atom of U-235 = 191 MeV
- Therefore, specific energy of U-235 = $(2.562 \times 10^{24}) \times 191 = 4.893 \times 10^{26} \text{ MeV kg}^{-1}$
- To convert 1 MeV = $10^6 \times (1.6 \times 10^{-19}) \text{ J}$
- Specific energy of U-235 = $(4.893 \times 10^{26}) \times 10^6 \times (1.6 \times 10^{-19}) = 7.83 \times 10^{13} \text{ J kg}^{-1}$

Step 4: Use the relationship between power, energy and efficiency to determine the mass

- The input power required is:

$$\text{efficiency \& power: } e = \frac{P_{out}}{P_{in}} \Rightarrow P_{in} = \frac{P_{out}}{e}$$

$$\text{input power: } P_{in} = \frac{500}{0.35} = 1429 \text{ MW}$$

$$\text{input power: } P_{in} = \frac{E_{in}}{t} = 1429 \times 10^6 \text{ J s}^{-1}$$

- Therefore, the mass of U-235 required in a day is:



Your notes

$$\text{mass of } ^{235}\text{U} (\text{kg s}^{-1}) = \frac{E_{in} (\text{J})}{1 \text{ s}} \times \frac{1 \text{ kg}}{\text{specific energy of } ^{235}\text{U} (\text{J})}$$

mass of U-235 (per second) =

$$\frac{1429 \times 10^6}{1} \times \frac{1}{7.83 \times 10^{13}} = 1.82 \times 10^{-5} \text{ kg s}^{-1}$$

mass of U-235 (per day) = $(1.82 \times 10^{-5}) \times 86\,400 = 1.58 \text{ kg}$

- Therefore, **1.58 kg of uranium-235** is required per day to run a 500 MW power plant at 35% efficiency

(c) Ratio of the masses of coal and U-235

- Since specific energy $\propto \frac{1}{\text{mass}}$

$$\frac{\text{specific energy of } ^{235}\text{U}}{\text{specific energy of coal}} \propto \frac{\text{mass of coal required per day}}{\text{mass of } ^{235}\text{U required per day}}$$

- Where the energy density of coal = 35 MJ kg^{-1}

$$\frac{\text{mass of coal required per day}}{\text{mass of } ^{235}\text{U required per day}} = \frac{7.83 \times 10^{13}}{35 \times 10^6} = 2.24 \times 10^6$$

- Over **2 million times** ($\sim 3.5 \times 10^6 \text{ kg}$) more coal is required than uranium-235 to achieve the same power output in a day (or second, or month or year)

Examiner Tip

If you need to brush up on binding energy calculations, take a look at the Mass Defect & Nuclear Binding Energy revision notes.



Your notes

Chain Reactions from Fission

Chain Reactions

- One of the many decay reactions uranium-235 can undergo is shown below:

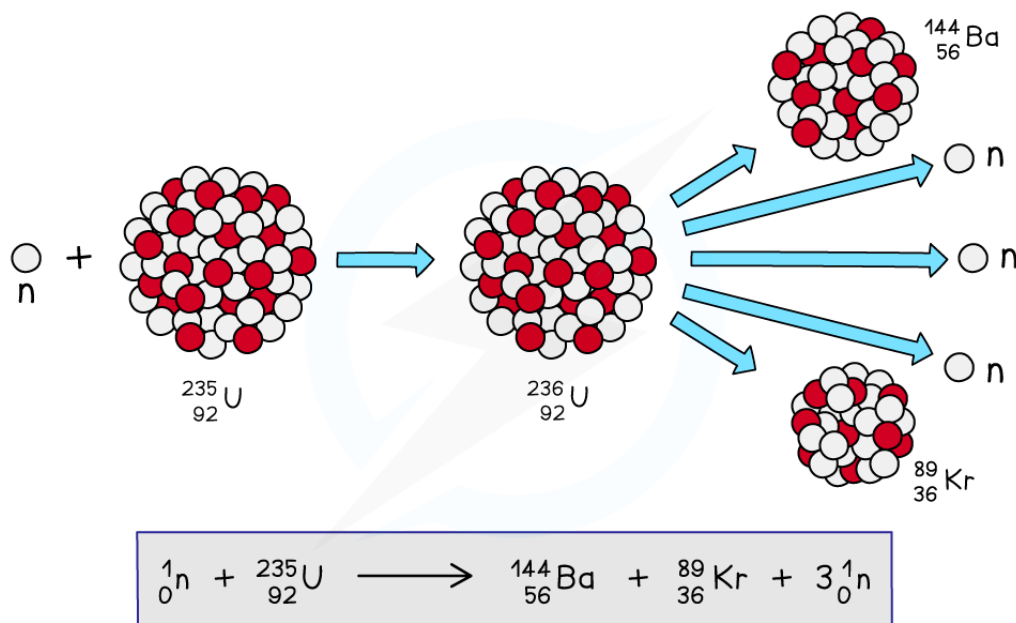

Uranium-235 decay chain from nuclear fission

- Neutrons involved in induced fission are known as **thermal neutrons**
- Thermal neutrons have low energy and speed meaning they can induce fission
 - This is important as neutrons with too much energy will rebound away from the uranium-235 nucleus and fission will not take place
- Only one extra neutron is required to induce a Uranium-235 nucleus to split by fission
- During the fission, it produces two or three neutrons which move away at high speed
- Each of these new neutrons can start another fission reaction, which again creates further **excess neutrons**
- This process is called a **chain reaction**



Your notes

CHAIN REACTIONS INCREASE
THE NUMBER OF REACTIONS
HAPPENING QUICKLY

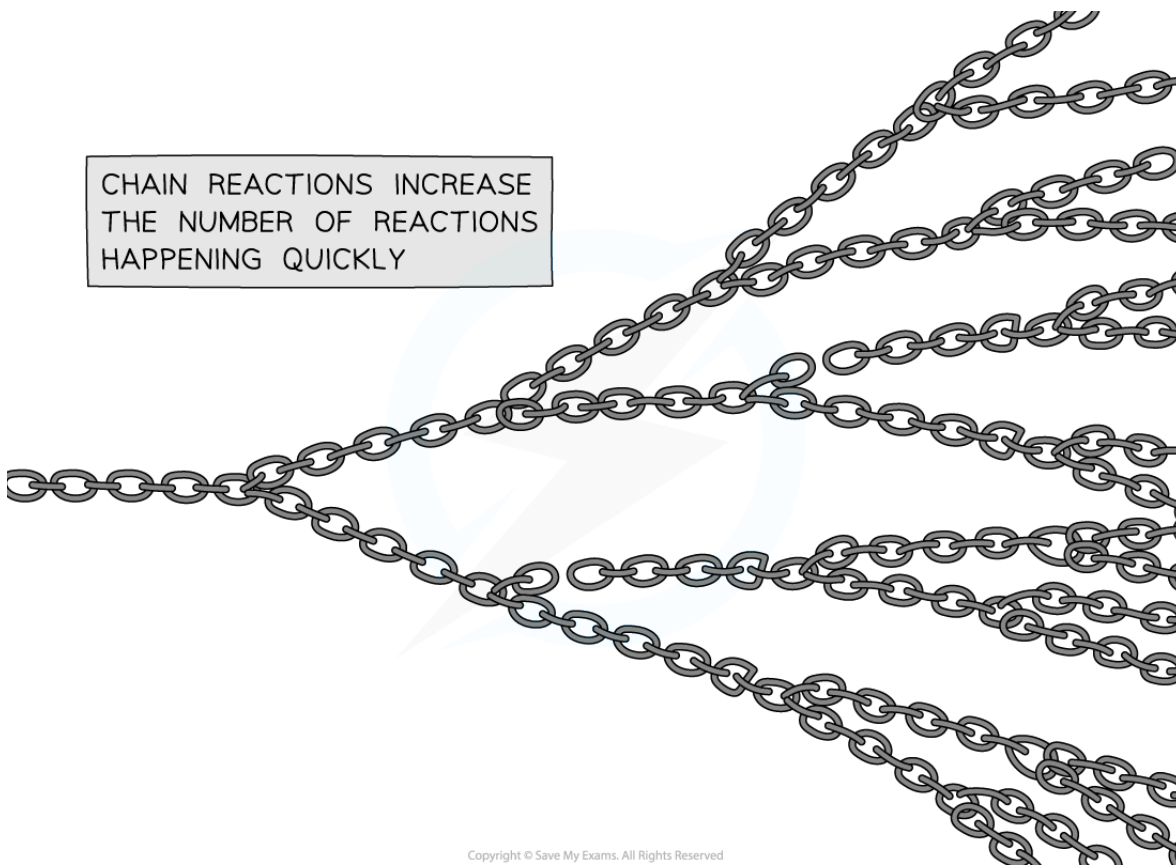

Copyright © Save My Exams. All Rights Reserved

The neutrons released by each fission reaction can go on to create further fissions, like a chain that is linked several times – from each chain comes two more

- The products of fission are two daughter nuclei and **at least one neutron**
- The neutrons released during fission go on to cause more fission reactions leading to a **chain reaction**, where each fission goes on to cause at least one more fission

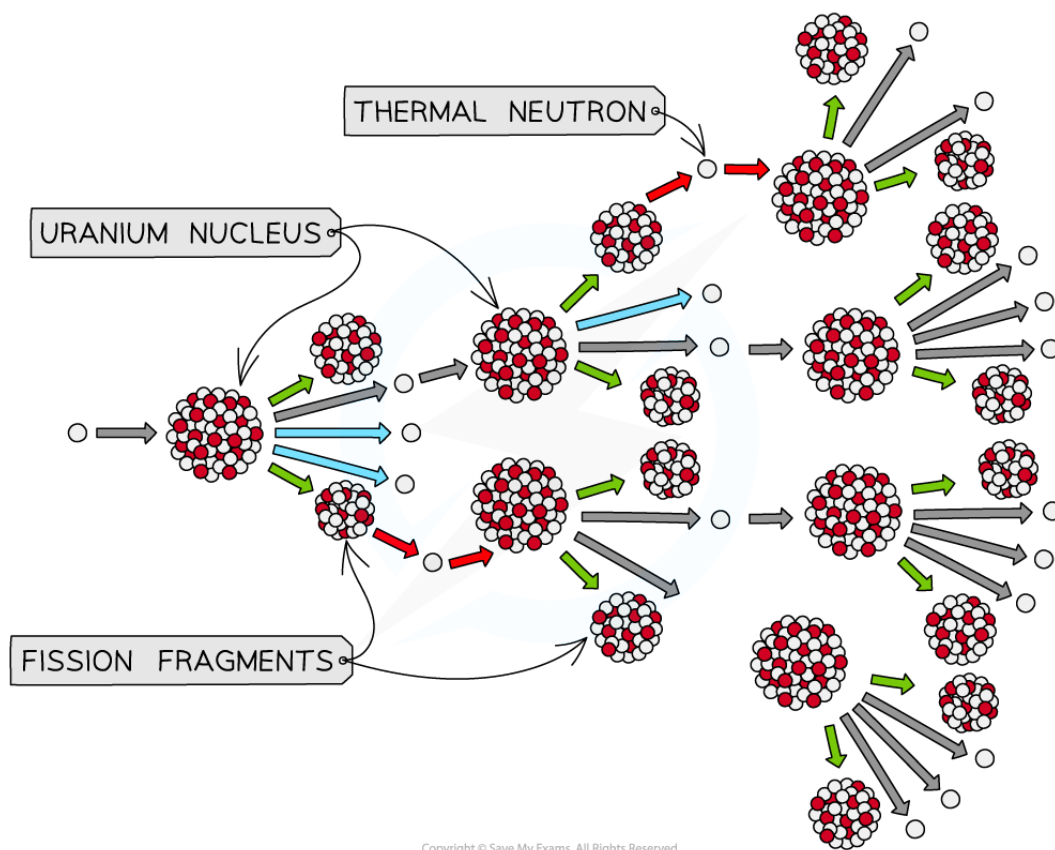

Only one thermal neutron is used to create another fission reaction in a controlled chain reaction

- Nuclear reactions are designed to be self-sustaining yet very controlled
- This can be achieved by using a precise amount of uranium fuel, known as the **critical mass**
- The critical mass is defined as:

The minimum mass of fuel required to maintain a steady chain reaction

- Using exactly the critical mass of fuel will mean that a single fission reaction follows the last
 - Using **less** than the critical mass (**subcritical mass**) would lead the reaction to eventually stop
 - Using **more** than the critical mass (**supercritical mass**) would lead to a runaway reaction and eventually an explosion



Your notes

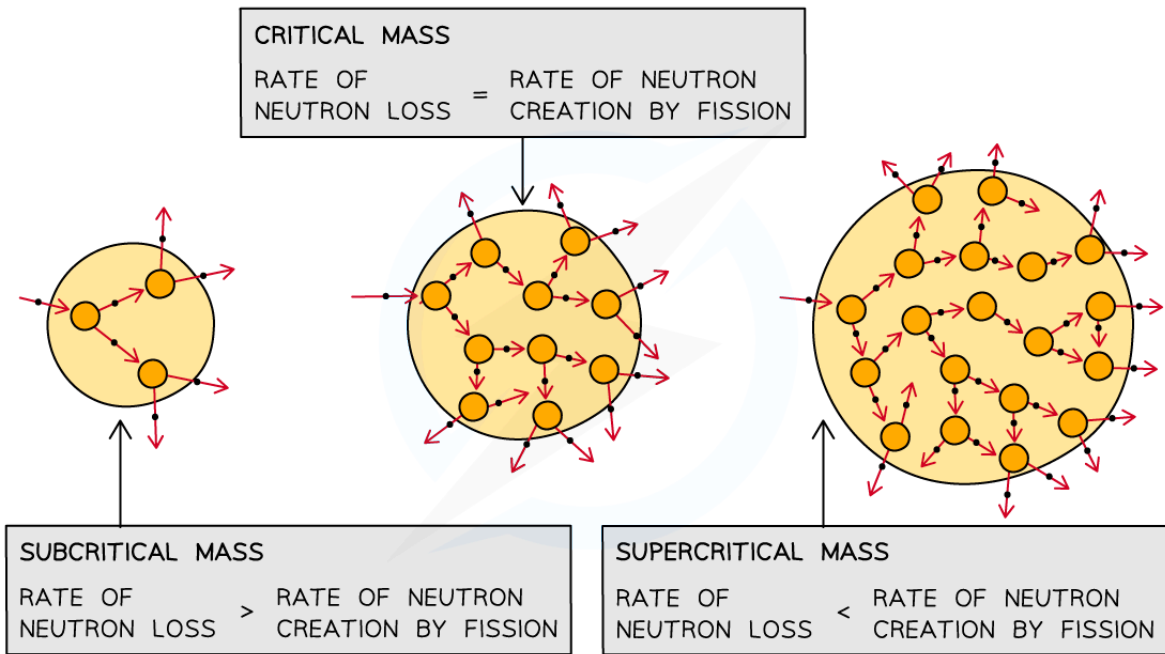

Copyright © Save My Exams. All Rights Reserved

Subcritical, critical and supercritical mass



Your notes

Operation of a Nuclear Reactor

Operation of a Nuclear Reactor

- In a nuclear reactor, a chain reaction is required to keep the reactor running
- When the reactor is producing energy at the required rate, two factors must be controlled:
 - The **number** of free neutrons in the reactor
 - The **energy** of the free neutrons
- The main components of a nuclear reactor are:
 - Control rods
 - Moderators
 - Heat exchangers
 - Shielding

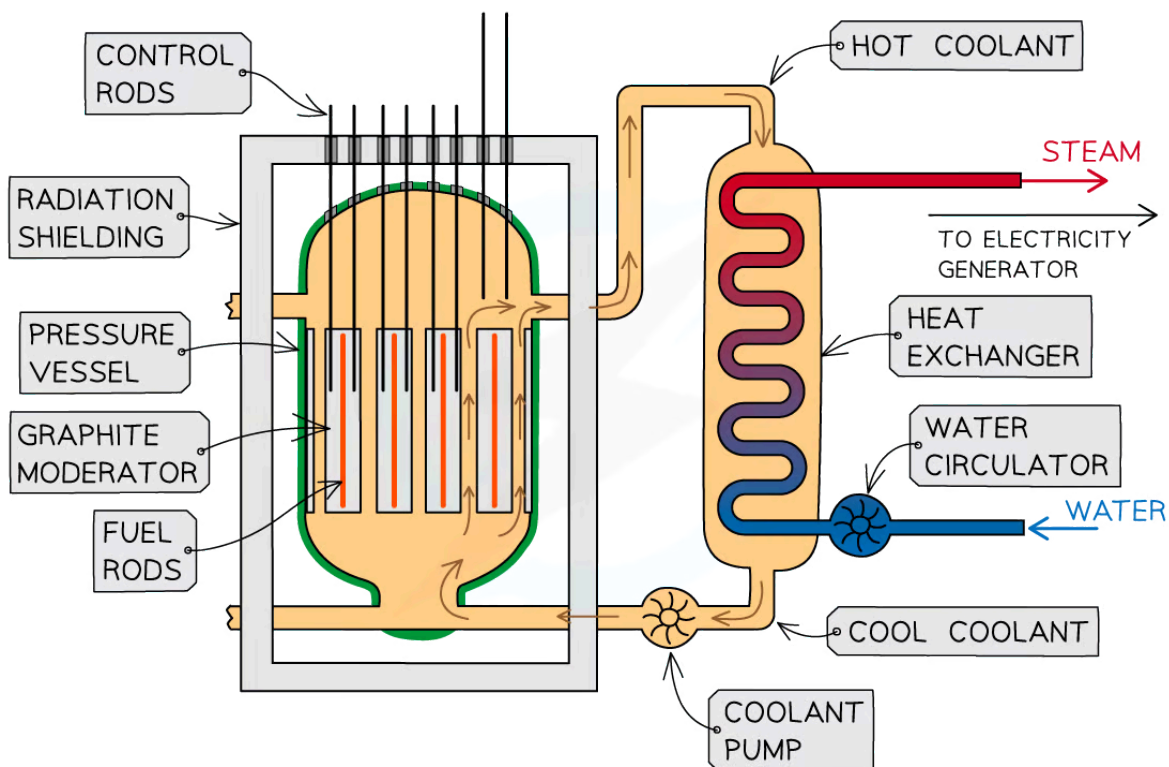

Copyright © Save My Exams. All Rights Reserved

The overall purpose of a nuclear reactor is to collect the heat energy produced from nuclear reactions

Control Rods

Purpose of a control rod: To absorb neutrons

- Control rods are made of a material which **absorbs neutrons** without becoming dangerously unstable themselves



Your notes

- The number of neutrons absorbed is controlled by varying the depth of the control rods in the fuel rods
 - Lowering the rods further **decreases** the rate of fission, as more neutrons are absorbed
 - Raising the rods **increases** the rate of fission, as fewer neutrons are absorbed
- This is adjusted automatically so that exactly one fission neutron produced by each fission event goes on to cause another fission
- In the event the nuclear reactor needs to shut down, the control rods can be lowered all the way so no reaction can take place

Moderator

The purpose of a moderator: To slow down neutrons

- The moderator is a material that surrounds the **fuel rods** and **control rods** inside the reactor core
 - Moderators are made from materials that are **poor absorbers** of neutrons, such as water
- The fast-moving neutrons produced by the fission reactions **slow down** by colliding with the molecules of the moderator, causing them to lose some momentum
- The neutrons are slowed down so that they are in **thermal equilibrium** with the moderator, hence the term 'thermal neutron'
 - This ensures neutrons can react efficiently with the uranium fuel

Heat exchangers

The purpose of a heat exchanger: To transfer thermal energy efficiently between the water systems of a nuclear power plant

- There are multiple water systems in a nuclear power plant that need regulating
 - The coolant (usually water) used in the reactor vessel
 - The water and steam that drives the turbine
 - The condenser that cools the steam
- The heat exchanger mediates the thermal energy exchanges between these water systems
- The **coolant** is a substance, such as water, that is pumped into the reactor at a cold temperature to extract the heat released by the fission reactions
- In the heat exchanger, the coolant transfers the heat to water that is pumped in externally to produce steam
- This steam then goes on to power electricity-generating turbines



Your notes

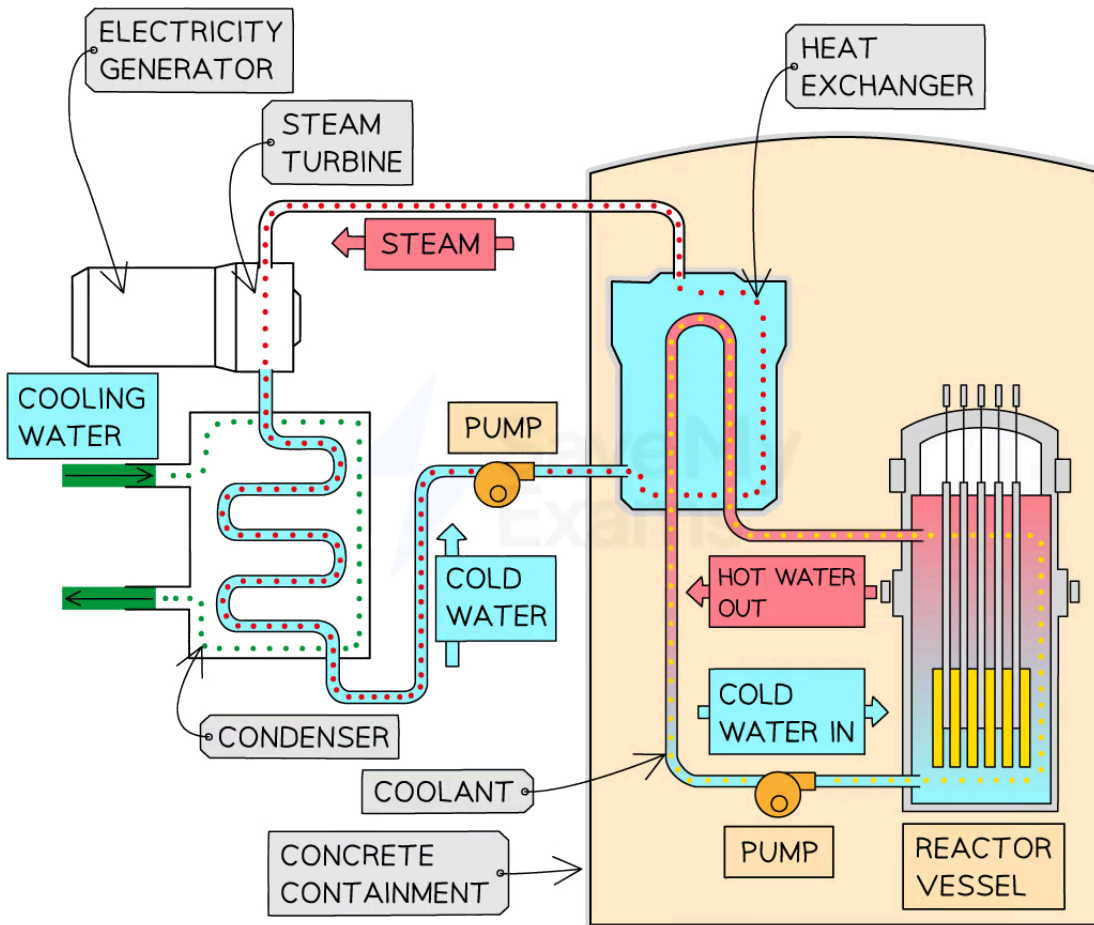

Copyright © Save My Exams. All Rights Reserved

Water systems in a nuclear power plant are regulated by a heat exchanger

Shielding

Purpose: To house the reactor and absorb hazardous radiation

- The entire nuclear reactor is surrounded by **shielding** materials
- The daughter nuclei formed during fission, and the neutrons emitted, are radioactive
- The reactor is surrounded by a **steel** and **concrete** wall that can be nearly 2 metres thick
- This absorbs the emissions from the reactions
 - It ensures that the environment around the reactor is **safe**

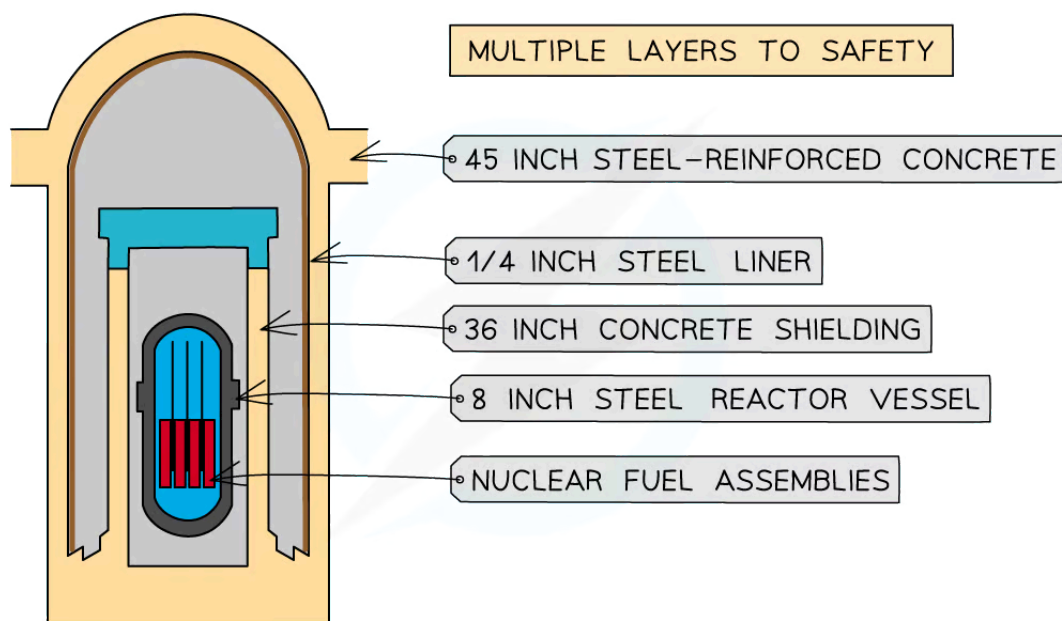

Copyright © Save My Exams. All Rights Reserved

Shielding metals in a nuclear reactor



Your notes

Radioactive Waste Management

Safety Issues in Nuclear Power

Types of Radioactive Waste

- There are three main types of nuclear waste:
 - Low level
 - Intermediate level
 - High level

Low-level waste

- This is waste such as clothing, gloves and tools which may be lightly contaminated
- This type of waste will be radioactive for a few years, so must be encased in concrete and stored a few metres underground until it can be disposed of with regular waste

Intermediate-level waste

- This is everything between daily used items and the fuel rods themselves
- Usually, this is the waste produced when a nuclear power station is decommissioned and taken apart
- This waste will have a longer half-life than the low-level waste, so must be encased in cement in steel drums and stored securely underground

High-level waste

- High-level waste refers to the unusable fission products from the fission of uranium-235 or from spent fuel rods
- This is by far the **most dangerous** type of waste as it will remain radioactive for thousands of years
- As well as being highly radioactive, the spent fuel rods are **extremely hot** and must be handled and stored much more carefully than the other types of waste
- The **issues** with high-level waste are:
 - Within the fuel rods, nuclei of **uranium-238** quickly decay into nuclei of **plutonium-239**
 - Plutonium-239 is classified as **high-level radioactive waste**
 - This is because its nuclei are extremely radioactive and have a **very long half-life** of 24 000 years
 - This presents a long-term risk of **contamination**
- The **treatment** of high-level waste is as follows:
 - The waste is initially placed in cooling ponds of water close to the reactor for a number of years
 - Isotopes of plutonium and uranium are harvested to be used again
 - Waste is mixed with molten glass and made solid (this is known as **vitrification**)
 - Then it is encased in containers made from steel, lead, or concrete
 - This type of waste must be stored very **deep** underground



Your notes

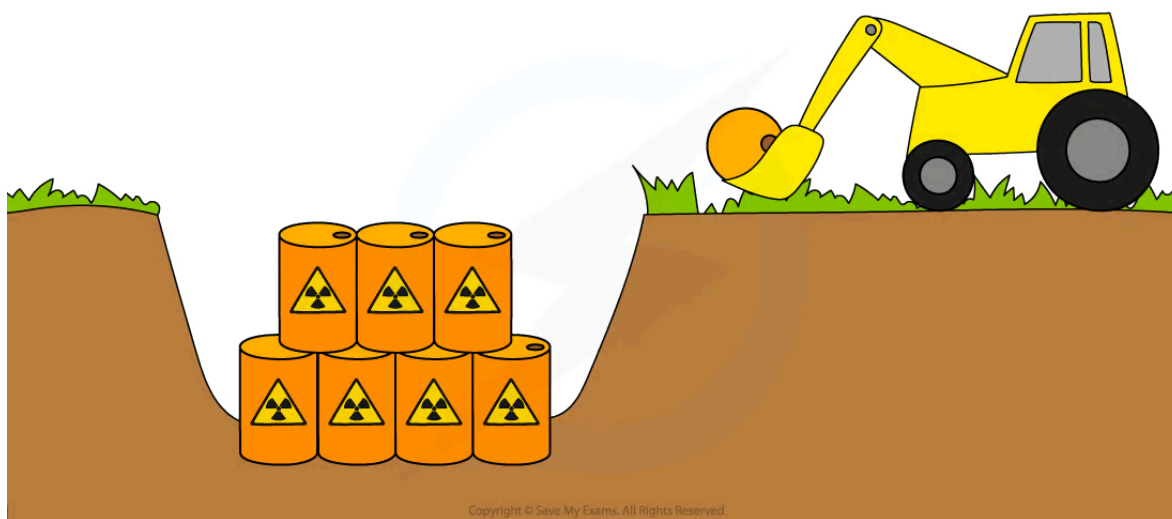

Depending on the activity of radioactive waste, it is buried in different ways

Advantages & Disadvantages of Nuclear Power

Advantages of using nuclear power:

- **Climate change friendly:** Nuclear power stations produce **no greenhouse gases**
- **High energy density:** Uranium provides far **more energy per kg** compared to coal and other fossil fuels
- **Availability of fuel:** The reserves of fissionable materials are much higher compared to fossil fuel reserves
- **High reliability & safety:** Despite some serious incidents in the past, nuclear power is now regarded as one of the safest and most reliable processes for the production of electricity

Disadvantages of using nuclear power:

- **Hazardous waste products:** The production of radioactive waste is very dangerous and expensive to deal with and stays at hazardous levels of activity for a very long time (>1000s of years)
- **Potential for catastrophic accidents:** A nuclear meltdown, such as at Chernobyl, could have catastrophic consequences on the environment and for the people living in the surrounding area
- **Potential for misuse:** There is a danger of misuse of nuclear material and infrastructure in nuclear weapons and terrorist attacks
- **Dangers with mining fuel:** There are many issues associated with mining uranium, from the people

handling it to the detrimental effects it can have on the environment



Your notes

Environmental Considerations

- Isotopes with long half-lives must not enter our water and food supplies
- Burial locations must be geologically stable, secure from attack, and designed for safety
- Space for such locations is limited

Safety Measures for Workers

- Several measures must be put in place to reduce the worker's exposure to radiation
- The fuel rods are **handled remotely** i.e. by machines
- The nuclear reactor is surrounded by a very thick lead or concrete **shielding** to limit exposure to radiation
- In an emergency, the control rods are fully lowered into the reactor core to stop fission reactions by absorbing all the free neutrons in the core, this is known as an **emergency shut-down**

Nuclear Energy in Society

- Nuclear power can scare people if they do not understand it
- It is dangerous if not handled properly, yet it is invisible which can be difficult for some people to comprehend
- However, with increased education on nuclear energy, society can use this knowledge to inform their own decisions and opinions