

DP IB Chemistry: SL



Your notes

4.3 Intermolecular Forces & Metallic Bonding

Contents

- * 4.3.1 Types of Intermolecular Forces
- * 4.3.2 Deducing Intermolecular Forces
- * 4.3.3 Properties of Covalent Compounds
- * 4.3.4 Metallic Bonding
- * 4.3.5 Trends in Melting Points of Metals
- * 4.3.6 Alloys & their Properties

4.3.1 Types of Intermolecular Forces



Your notes

Intermolecular Forces

- There are no covalent bonds between molecules in molecular covalent compounds. There are, however, forces of attraction between these molecules, and it is these which must be overcome when the substance is melted and boiled
- These forces are known as **intermolecular forces**
- There are three main types of **intermolecular forces**:
 - London (dispersion) forces
 - Dipole-dipole attraction
 - Hydrogen bonding

London (dispersion) forces

- The electrons in atoms are not static; they are in a state of constant motion
 - It is therefore likely that at any given time the distribution of electrons will not be exactly symmetrical - there is likely to be a slight surplus of electrons on one side of the atoms

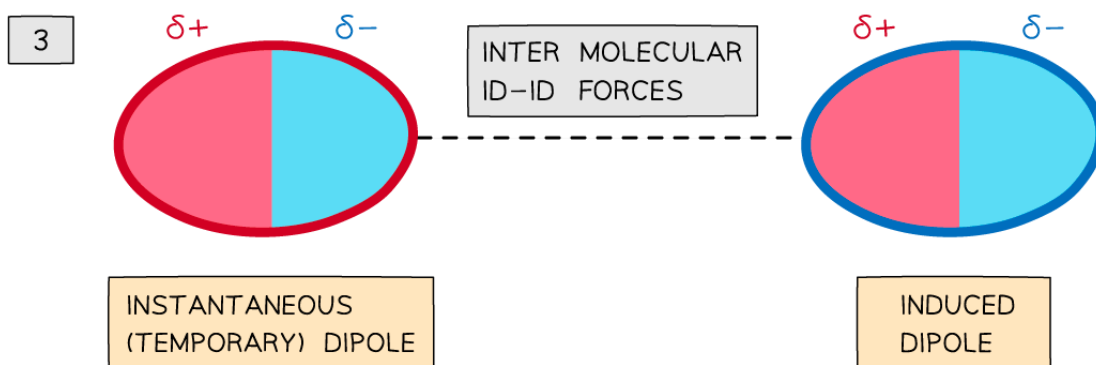
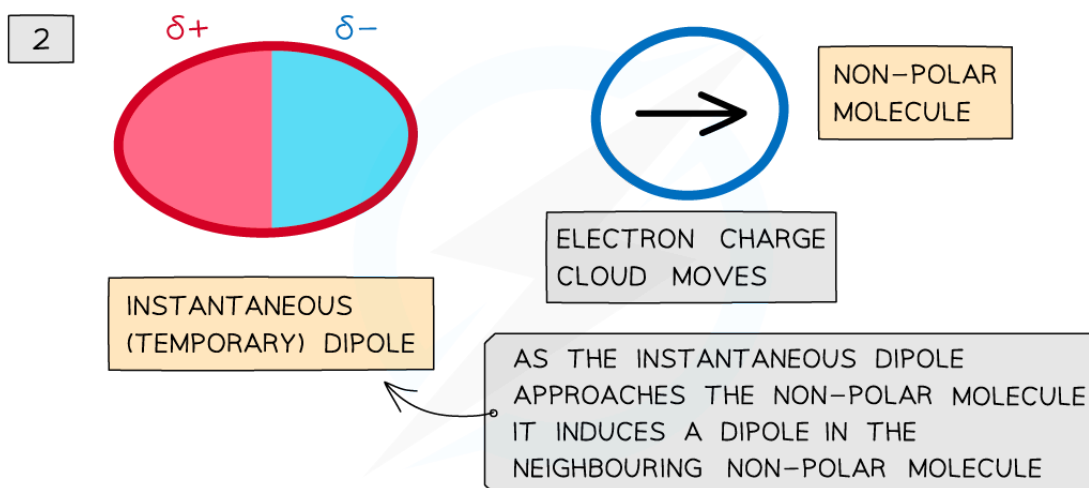
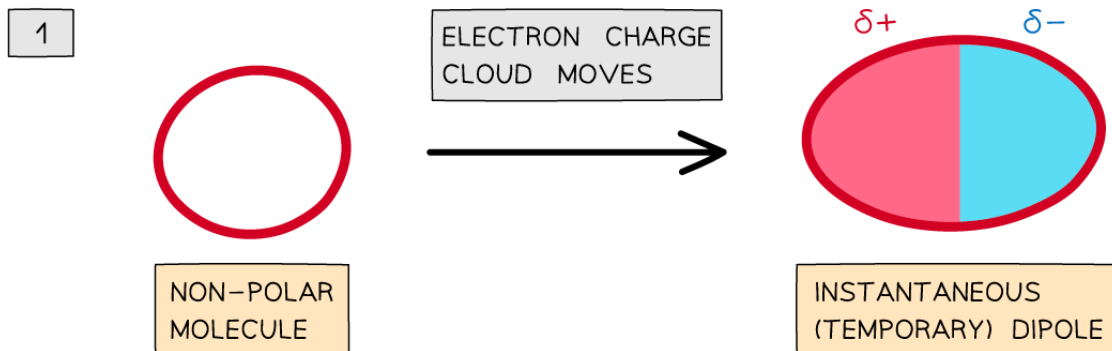

Copyright © Save My Exams. All Rights Reserved

London (Dispersion) forces

- This is known as a **temporary dipole**
 - It lasts for a very short time as the electrons are constantly moving



Your notes

- **Temporary dipoles** are constantly appearing and disappearing
- Consider now an adjacent atom. The electrons on this atom are repelled by the negative part of the dipole and attracted to the positive part and move accordingly
- This is a **temporary induced dipole**
 - There is a resulting attraction between the two atoms, and this known as **London (dispersion) forces**, after the German chemist, Fritz London
- **London (dispersion) forces** are present between all atoms and molecules, although they can be very weak
 - They are the reason all compounds can be liquefied and solidified
 - **London (dispersion) forces** tend to have strengths between 1 kJmol^{-1} and 50 kJmol^{-1} .
- The strength of the **London (dispersion) forces** in between molecules depends on two factors:
 - the number of electrons in the molecule
 - Surface area of the molecules

Number of electrons

- The greater the number of electrons in a molecule, the greater the likelihood of a distortion and thus the greater the frequency and magnitude of the temporary dipoles
- The dispersion forces between the molecules are stronger and the melting and boiling points are larger
- The enthalpies of vaporisation and boiling points of the noble gases illustrate this factor:

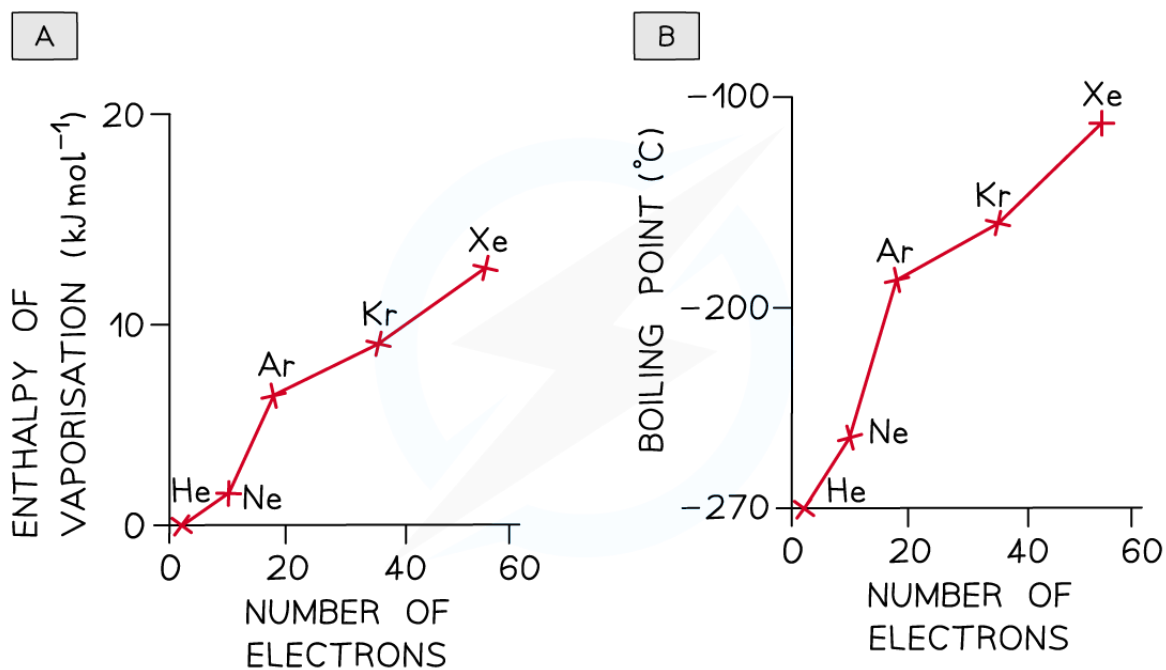

Copyright © Save My Exams. All Rights Reserved

As the number of electrons increases more energy is needed to overcome the forces of attraction between the noble gases atoms

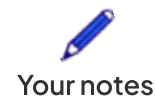

Surface area

- The larger the surface area of a molecule, the more contact it will have with adjacent molecules
- The greater its ability to induce a dipole in an adjacent molecule, the greater the **London (dispersion) forces** and the higher the melting and boiling points
- This point can be illustrated by comparing different isomers containing the same number of electrons:

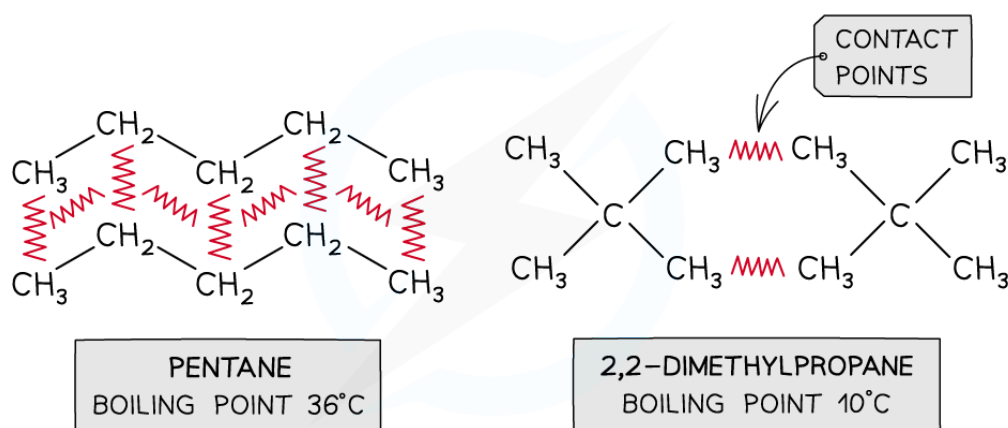

Copyright © Save My Exams. All Rights Reserved

Boiling points of molecules with the same numbers of electrons but different surface areas

Dipole-dipole attractions

- Temporary dipoles exist in all molecules, but in some molecules there is also a **permanent dipole**
- In addition to the **London (dispersion) forces** caused by temporary dipoles, molecules with permanent dipoles are also attracted to each other by **permanent dipole-dipole bonding**

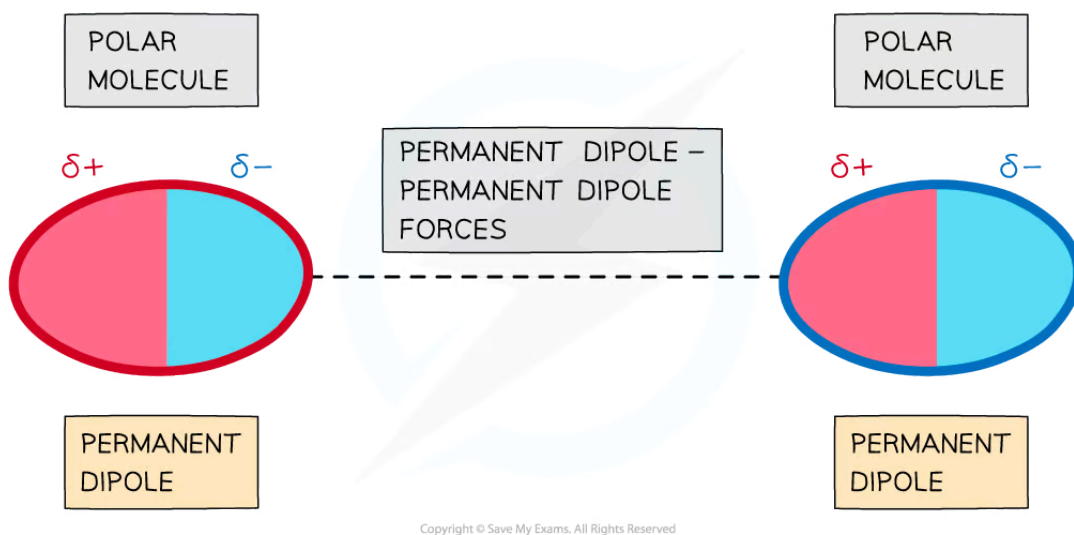

The delta negative end of one polar molecule will be attracted onwards the delta positive end of a neighbouring polar molecule

- This is an attraction between a **permanent dipole** on one molecule and a **permanent dipole** on another.
- **Dipole-dipole bonding** usually results in the boiling points of the compounds being slightly higher than expected from temporary dipoles alone
 - it slightly increases the strength of the intermolecular attractions
- The effect of **dipole-dipole bonding** can be seen by comparing the melting and boiling points of different substances which should have **London(dispersion) forces** of similar strength

Comparing butane and propanone

- For small molecules with **the same number of electrons**, **dipole-dipole attractions** are **stronger** than **dispersion forces**
 - Butane and propanone have the same number of electrons
 - Butane is a nonpolar molecule and will have only dispersion forces
 - Propanone is a polar molecule and will have dipole-dipole attractions and dispersion forces
 - Therefore, more energy is required to break the intermolecular forces between propanone molecules than between butane molecules
 - The result is that propanone has a higher boiling point than butane

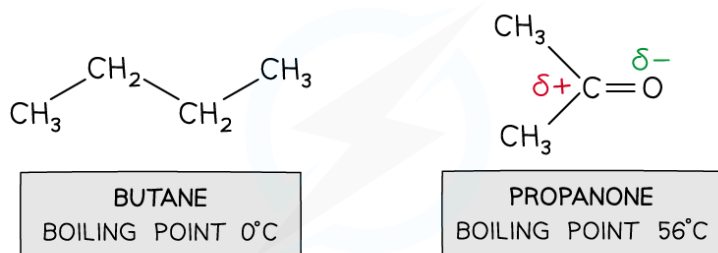

Copyright © Save My Exams. All Rights Reserved

Comparing substances with permanent and temporary dipoles in smaller molecules with an equal number of electrons

Hydrogen bonding

- Hydrogen bonding is the **strongest** type of **intermolecular force**
 - Hydrogen bonding is a special type of **permanent dipole – permanent dipole** bonding
- For hydrogen bonding to take place the following is needed:
 - A species which has an **O** or **N** or **F** (very **electronegative**) atom with an available **lone pair** of electrons
 - A hydrogen attached to the **O, N** or **F**
- When hydrogen is covalently bonded to an **electronegative** atom, such as **O** or **N**, the bond becomes very highly **polarised**
- The H becomes so δ^+ charged that it can form a bond with the **lone pair** of an **O** or **N** atom in another molecule

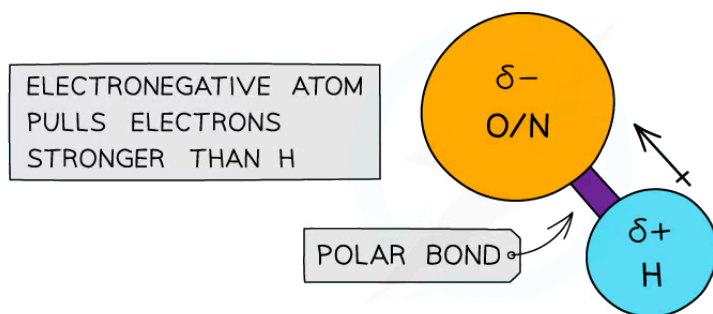

Copyright © Save My Exams. All Rights Reserved

The electronegative atoms O or N have a stronger pull on the electrons in the covalent bond with hydrogen, causing the bond to become polarised

- Hydrogen bonds are represented by dots or dashes between H and the N/O/F element
- The number of hydrogen bonds depends on:

- The number of hydrogen atoms attached to O or N in the molecule
- The number of **lone pairs** on the O or N



Your notes

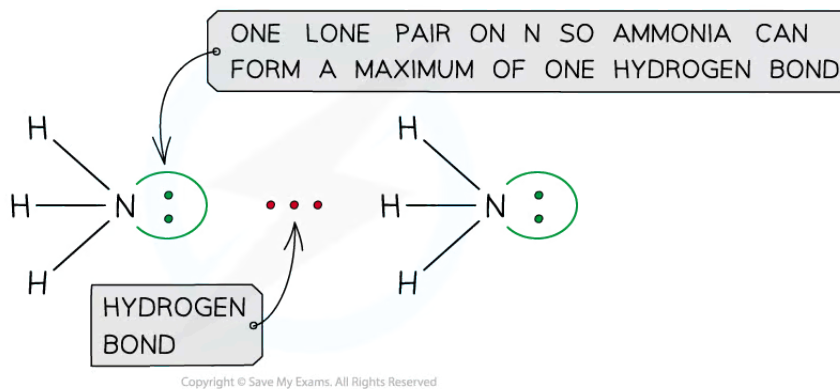

Ammonia can form a maximum of one hydrogen bond per molecule

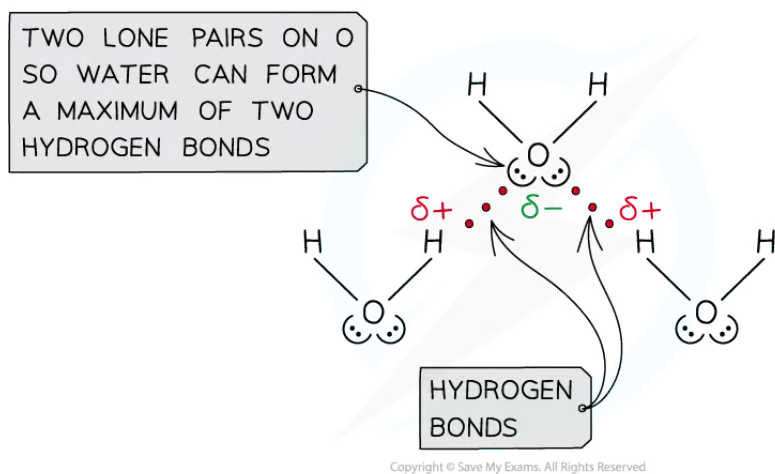

Water can form a maximum of two hydrogen bonds per molecule

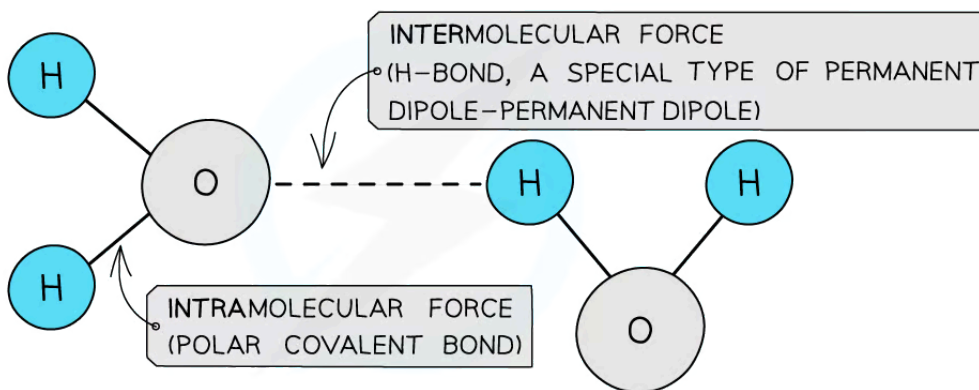

The polar covalent bonds between O and H atoms are intramolecular forces and the permanent dipole – permanent dipole forces between the molecules are intermolecular forces as they are a type of van der Waals’ force

Examiner Tip

The term “London (dispersion) forces” refers to instantaneous induced dipole induced dipole forces that exist between any atoms or groups of atoms and should be used for non-polar species. You may be wondering about the term “van der Waals” forces: it is an inclusive term and refers to dipole-dipole, dipole-induced dipole and London (dispersion) forces



Your notes

4.3.2 Deducing Intermolecular Forces

Deducing Intermolecular Forces

- In order to deduce the types of **intermolecular forces** present in molecules you need information about the structure and chemical formula of the molecules
- The chemical formula will tell you about the presence of electronegative elements present in the molecule
 - Any potential polar bonds can be identified
 - If N, O or F is present then hydrogen bonds are potentially possible
- The structure and symmetry of the molecule will enable you to determine if the molecule is polar following the principles laid out in **4.1.10 Molecular Polarity**

Worked example

Which of the compounds below can form intermolecular hydrogen bonds in the liquid state?

- A. $(\text{CH}_3\text{CH}_2)_3\text{N}$
- B. CH_3OCH_3
- C. CCl_4
- D. $\text{C}_2\text{H}_5\text{OH}$

Answer:

The correct option is **D**.

- Draw the displayed structures of the molecules:

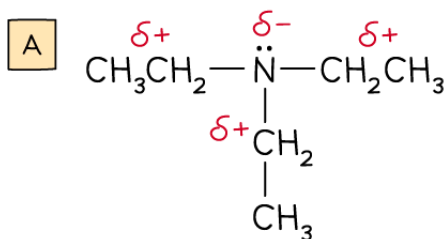

POLAR BONDS
ASYMMETRICAL
POLAR MOLECULE

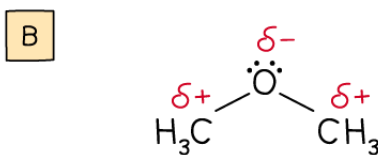

POLAR BONDS
ASYMMETRICAL
POLAR MOLECULE

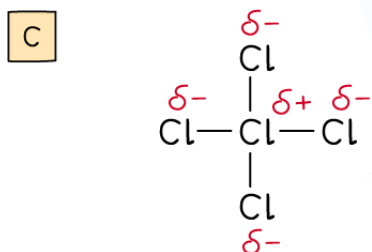

POLAR BONDS SYMMETRICAL
NON-POLAR MOLECULE

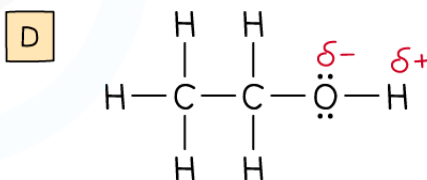

POLAR BONDS ASYMMETRICAL
POLAR MOLECULE H ATTACHED
TO NOF ELEMENT

Copyright © Save My Exams. All Rights Reserved

- Molecules **A** and **B** form dipole-dipole attractions as they are polar molecules
- Molecule **C** forms dispersion forces as the dipoles cancel out so there is no overall polarity
- Molecule **D** is the only one capable of forming hydrogen bonds

Examiner Tip

Sometimes a question will ask you to name all the IMFs present in molecules and students frequently forget to include dispersion forces which are present in all molecules, since everything contains electrons!



Your notes

4.3.3 Properties of Covalent Compounds

Properties of Covalent Compounds

- The physical properties of **molecular covalent compounds** are largely influenced by their **intermolecular forces**
- If you know the type of **intermolecular forces** present you can predict the physical properties like **melting** and **boiling point**, **solubility**, and **conductivity**

Melting and boiling point

- When covalent molecular substances change state you are overcoming the **intermolecular forces**
- The stronger the forces the more energy need to break the attraction
- **Intermolecular forces** are much weaker than covalent bonds, so many covalent substances are liquid or gases at room temperature
- Substance with a low melting and boiling point are said to be very **volatile**
- The strength of the intermolecular forces increases with
 - the **size** of the molecule
 - the increase in the **polarity** of the molecule
 - Drawing the structure of the molecule helps identify and rank molecules according to boiling point as the following example shows:

Worked example

Place these three molecules in the correct order from lowest to highest boiling point and explain your reasoning:

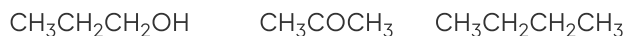

Answer:

Step 1: The first thing to do is find the approximate relative molecular mass:

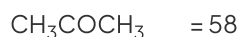
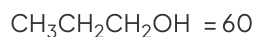

This tells you the molecules are approximately the same size so the dispersion forces will be similar

Step 2: Draw the structures of the molecules and identify the intermolecular forces present

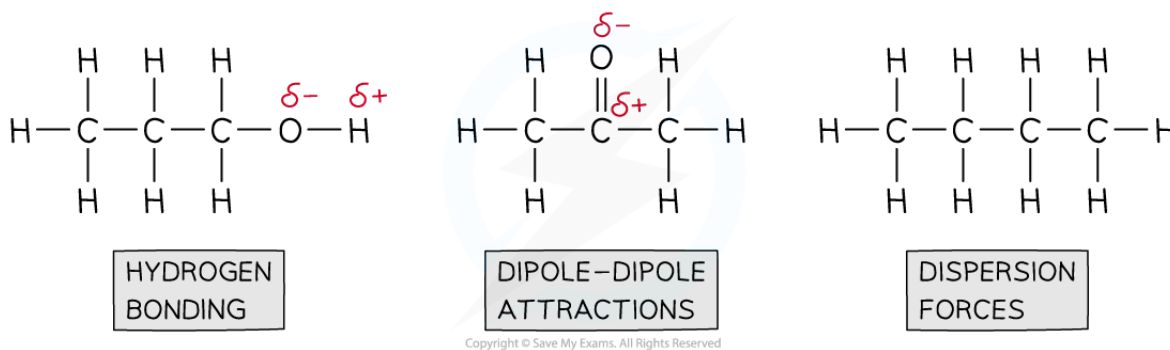

So, the order of boiling from lowest to highest is:

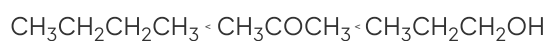

Solubility

- The general principle is that 'like dissolves like' so non-polar substances mostly dissolve in non-polar solvents, like hydrocarbons and they form dispersion forces between the solvent and the solute
- Polar covalent substances generally dissolve in polar solvents as a result of dipole-dipole interactions or the formation of hydrogen bonds between the solute and the solvent
- A good example of this is seen in organic molecules such as alcohols and water:

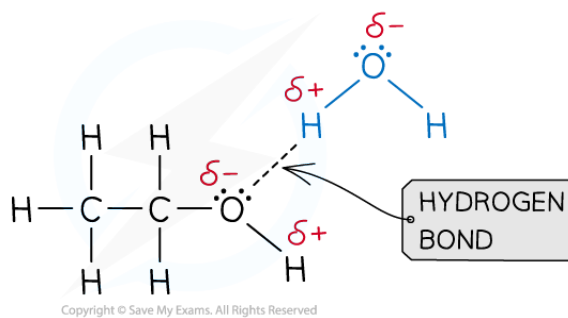

Hydrogen bonds form between ethanol and water

- As covalent molecules become larger their solubility can decrease as the polar part of the molecule is only a smaller part of the overall structure
 - This effect is seen in alcohols for example where ethanol, $\text{C}_2\text{H}_5\text{OH}$, is readily soluble but hexanol, $\text{C}_6\text{H}_{13}\text{OH}$, is not
- Polar covalent substances are unable to dissolve well in non-polar solvents as their dipole-dipole attractions are unable to interact well with the solvent
- Giant covalent substances generally don't dissolve in any solvents as the energy needed to overcome the strong covalent bonds in the lattice structures is too great



Your notes

Conductivity

- As covalent substances do not contain any freely moving charged particles they are unable to conduct electricity in either the solid or liquid state
- However, under certain conditions some polar covalent molecules can ionise and will conduct electricity
- Some giant covalent structures are capable of conducting electricity due to delocalised electrons, as seen in Section 4.1.11 **Giant Covalent Structures**, but they are exceptions to the general rule

Comparing the Properties of Covalent Compounds Table

	Non-polar covalent substances	Polar covalent substances	Giant covalent substances	Ionic substances
Melting and boiling point	Low	Low	Very high	Very high
Volatility	Highest	High	Low	Low
Solubility in polar solvents	Insoluble	Some solubility depending on molecular size	Insoluble	Soluble
Solubility in non-polar solvents	Soluble	Some solubility depending on molecular size	None	Insoluble
Electrical conductivity	None	None	None – except graphite, graphene	Only when molten or aqueous

Copyright © Save My Exams. All Rights Reserved



Your notes

Worked example

Compound X has the following properties:

Melting point	Electrical conductivity	
1450 °C	solid	molten
	poor	poor

Copyright © Save My Exams. All Rights Reserved

What is the most probable structure of X?

- A. Network covalent
- B. Polar covalent molecule
- C. Ionic lattice
- D. Metallic lattice

Answer:

The correct option is **A**

- A high melting point is characteristic of a giant structure, which could be metallic, ionic or covalent
- The poor conductivity as a liquid and solid would match a giant covalent or network covalent structure

4.3.4 Metallic Bonding



Your notes

Metallic Bonding

- **Metal** atoms are tightly packed together in **lattice** structures
- When the metal atoms are in **lattice** structures, the electrons in their outer shells are free to move throughout the structure
- The free-moving **electrons** are called '**delocalised**' electrons and they are not bound to their atom
- When the electrons are **delocalised**, the metal atoms become **positively** charged
- The positive charges **repel** each other and keep the neatly arranged lattice in place
- There are very strong **electrostatic forces** between the positive metal centres and the 'sea' of delocalised electrons

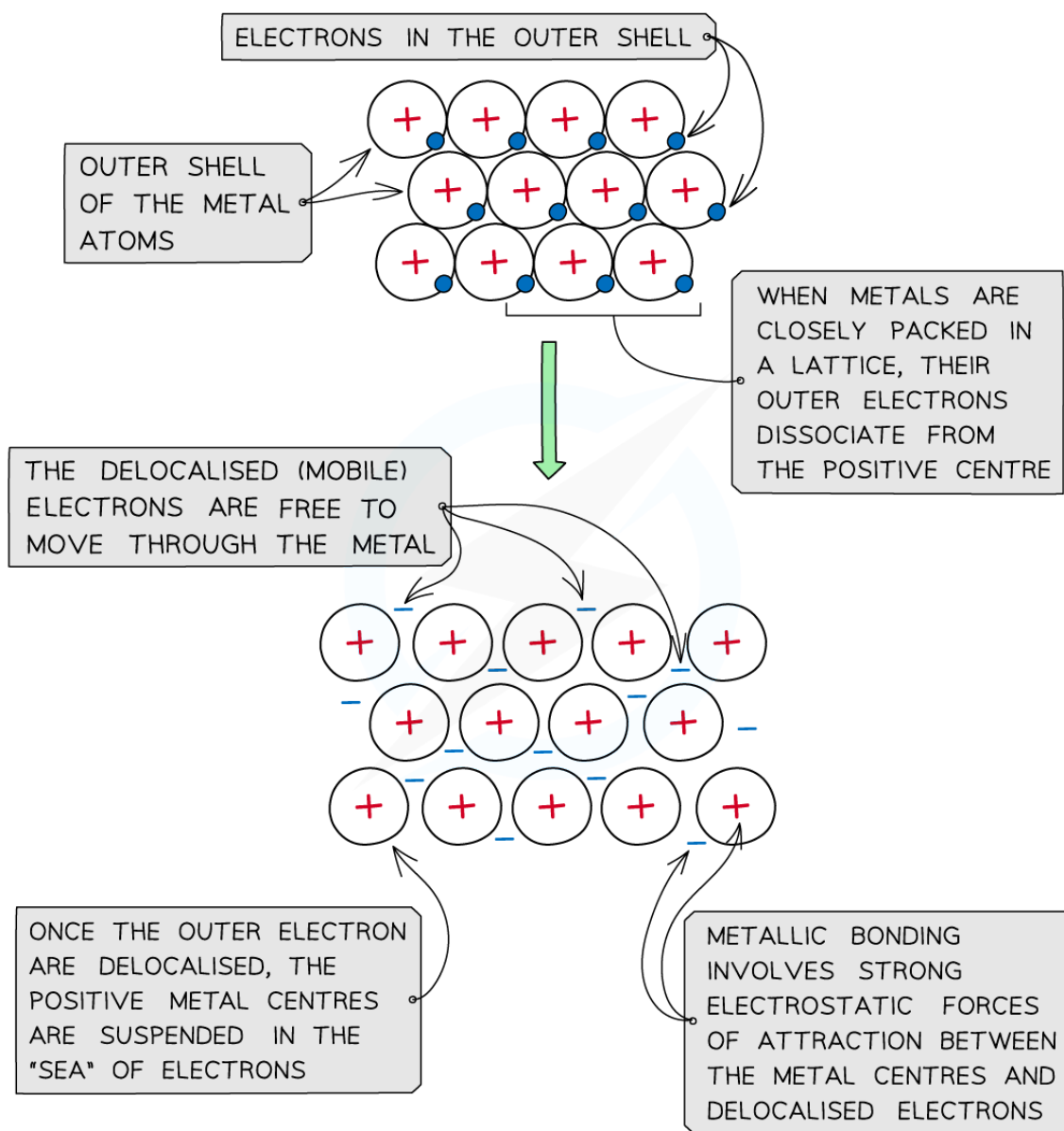

Copyright © Save My Exams. All Rights Reserved

The positive metal centres are suspended in a 'sea' of delocalised electrons



Your notes

Properties of Metals

- Metallic compounds are **malleable**
 - When a force is applied, the metal layers can slide
 - The **attractive forces** between the metal ions and electrons act in all directions
 - So when the layers slide, the metallic bonds are re-formed
 - The lattice is not broken and has changed shape

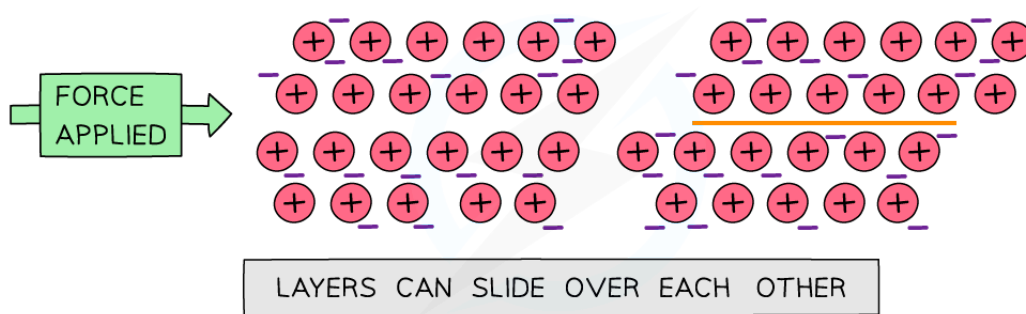

Copyright © Save My Exams. All Rights Reserved

- Metallic compounds are **strong** and **hard**
 - Due to the strong attractive forces between the metal ions and delocalised electrons
- Metals have **high melting** and **boiling points**

Conductivity

- Metals can **conduct electricity** when in the **solid** or **liquid** state
 - As both in the solid and liquid state there are **mobile electrons** which can freely move around and conduct electricity
- Since the bonding in metals is **non-directional**, it does not really matter how the **cations** are oriented relative to each other
- The metal **cations** can be moved around and there will still be delocalised electrons available to hold the **cations** together

Metallic Bonding Summary Table



Your notes

Property	Explanation
<p>High melting and boiling points</p>	<p>Positive metal atom centres and the delocalised electrons in a metallic lattice have strong electrostatic forces between them</p> <p>Therefore, high energy is needed to overcome the strong forces of attraction</p> <p>As the number of mobile charges increase from left to right of the Periodic Table, the melting and boiling points increase as the electrostatic forces become stronger</p>
<p>Electrical Conductivity</p>	<p>When a potential difference is applied to the metallic lattice, the delocalised electrons repel away from the negative terminal and move towards the positive terminal</p> <p>As the number of valence electrons increases across the Period, the number of delocalised charges also increases:</p> <ul style="list-style-type: none"> ◦ Sodium = 1 valence electron ◦ Magnesium = 2 valence electrons ◦ Aluminium = 3 valence electrons ◦ Etc. <p>Therefore the ability to conduct electricity also increases</p>

Copyright © Save My Exams. All Rights Reserved



Your notes

Strength of Metallic Bonds

Not all metallic bonds are equal. There are several factors that affect the **strength** of a metallic bond:

The charge on the metal ion

- The **greater the charge** on the metal ion, the greater the number of electrons in the sea of delocalised electrons and the greater the **charge difference** between the ions and the electrons
- A greater charge difference leads to a **stronger** electrostatic attraction, and therefore a stronger metallic bond
- This effect can be seen in melting point data across a period, as the charge on the metal ion **increases** without a significant change in ionic radius:

Group	1	2	3 (13)
Metal	Sodium	Magnesium	Aluminium
Melting point / K	371	923	933

The radius of the metal ion

- Metal ions with **smaller ionic radii** exert a greater attraction on the sea of delocalised electrons
- This greater attraction means a **stronger** metallic bond, requiring more energy to break
- This can be seen in data from metals, descending a group, where the charge on the ion remains constant but the ionic radius increases:

Period	3	4	5
Metal	Sodium	Potassium	Rubidium
Melting point / K	371	336	312



Your notes

4.3.5 Trends in Melting Points of Metals

Trends in Melting Points of Metals

- The **strength** of electrostatic attraction can be increased by:
 - **Increasing** the number of **delocalised electrons** per metal atom
 - **Increasing** the **positive charges** on the metal centres in the lattice
 - **Decreasing** the **size** of the metal ions
- These factors can be seen in the trends across a period and down a group

Melting points of metals across a period

- If you compare the electron configuration of sodium, magnesium and aluminium you can see the number of valence electrons increases
 - **Na** = $1s^2 2s^2 2p^6 3s^1$
 - **Mg** = $1s^2 2s^2 2p^6 3s^2$
 - **Al** = $1s^2 2s^2 2p^6 3s^2 3p^1$
- Aluminium ions are also a smaller size than magnesium ions or sodium ions and these two factors lead to **stronger** metallic bonding which can be seen in the melting points
- The **stronger** the metallic bonding, the **more energy** is need to break the metallic lattice and so the **higher** the melting point
- As we go across period 3 we can see the effect of stronger metallic bonding on the metals
 - Remember only the first three elements have metallic bonding in this graph



Your notes

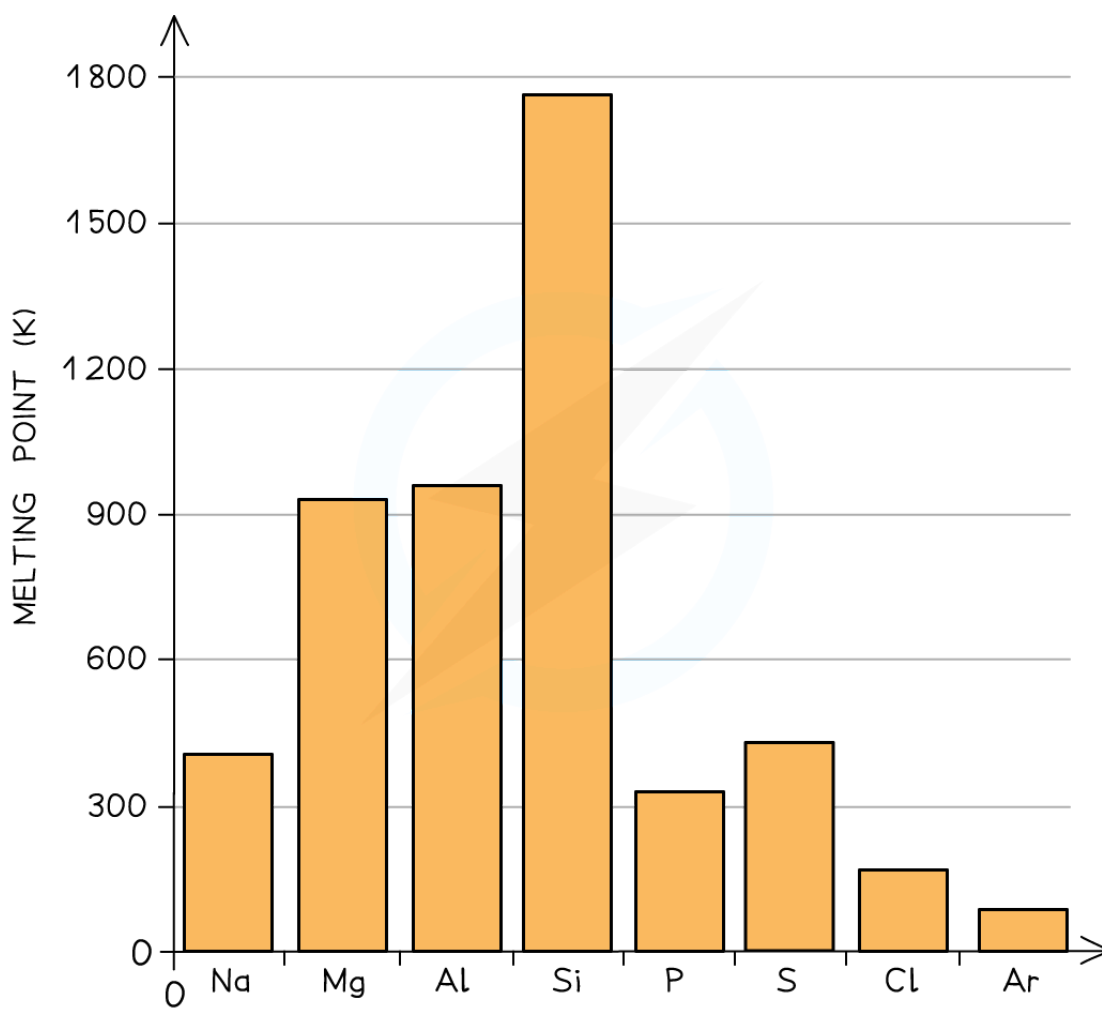

Melting points as you go across a period. The metallic bonding gets stronger from Na to Al

Melting points of metals down a group

- As you go **down the group** the size of the cation increases so this **decreases the attraction** between the valence electrons and the metallic lattice, leading to a reduction of the melting point



Your notes

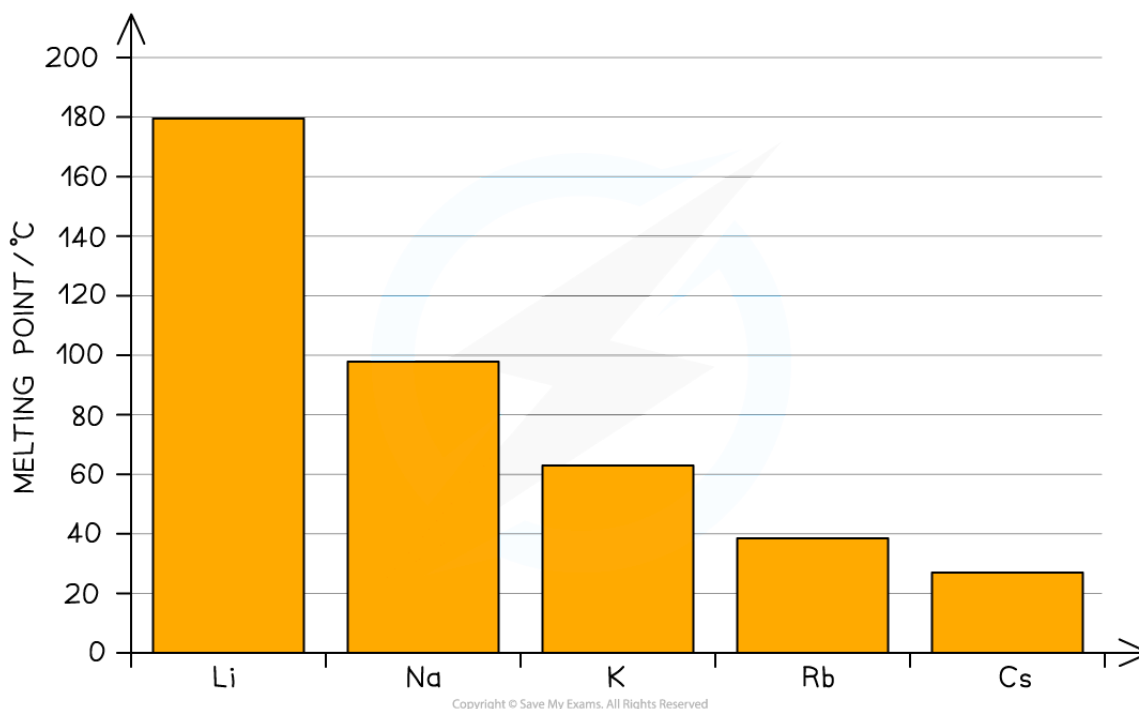

Melting points as you go down a group of metals. The metallic bonding gets weaker from Li to Cs

Examiner Tip

You see from the graph that the melting point of aluminium is not that much higher than magnesium. It is a reminder to us that these are trends and not rules about melting points and sometimes there are other factors which can result in subtle differences from what was expected. One factor here is the metal packing structure - this can also influence the melting point, but it is beyond what is required in the IB Chemistry syllabus. You just need to learn and explain the broad trends



Your notes

4.3.6 Alloys & their Properties

Alloys

- Alloys are mixtures of metals, where the metals are mixed together physically but are not chemically combined
- They can also be made from metals mixed with nonmetals such as carbon
- Ions of the different metals are spread throughout the **lattice** and are bound together by the **delocalized** electrons
- It is possible to form alloys because of the **non-directional** nature of the metallic bonds

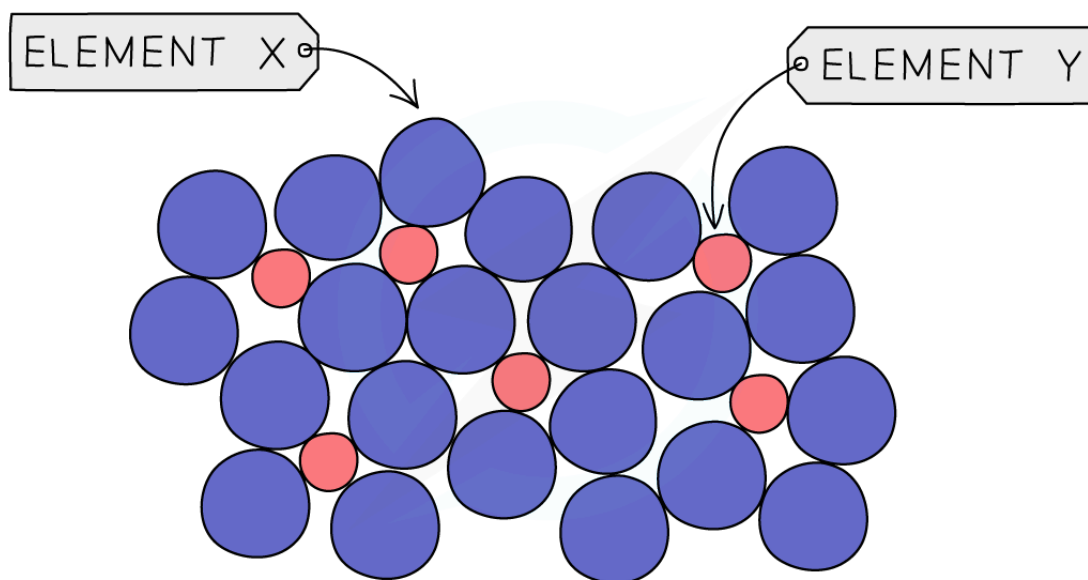

Copyright © Save My Exams. All Rights Reserved



In a metallic lattice the regular structure of metal cations (shown by Element Y) is disrupted by the presence of another element (Element X)

- Alloys have distinct properties due to the different packing of the cations in the lattice
- Alloys often have properties that can be very **different** to the metals they contain, for example they can have greater **strength**, **hardness** or **resistance** to **corrosion** or extreme **temperatures**
- Alloys contain atoms of **different** sizes, which **distorts** the regular arrangements of cations
- This makes it more difficult for the layers to slide over each other, so they are usually much harder than the pure metal

- Below is a table of some common alloys and their uses:



Your notes

Common Alloys and their Uses Table

Alloy	Elements present	Properties	Uses
Brass	copper and zinc	strong and resistant to corrosion	door handles, hinges, musical instruments
Steel	iron, carbon and other elements like chromium, vanadium, and molybdenum	very strong	construction, bridges, cars
Solder	lead and tin	low melting point	joining metals in electrical circuits and jewellery
Bronze	copper and tin	hard and strong resistant to corrosion	medals, sculptures, ship fittings

Copyright © Save My Exams. All Rights Reserved

Examiner Tip

You don't need to learn the specific alloys, but you should be able to use examples you know to explain why alloys have the properties they do compared to pure metals