



# HL IB Biology



## Gene Expression

### Contents

- \* Gene Expression (HL)
- \* Regulating Transcription & Translation (HL)
- \* Environment & Gene Expression (HL)
- \* Environment & Gene Expression: Examples (HL)



Your notes

## Gene Expression (HL)

### Gene Expression

- Gene expression is the mechanism by which the genetic code contained within DNA has an effect on the phenotype of an organism
- The most common stages of gene expression include:
  - Transcription** - during which the genetic code is transcribed into mRNA
    - This is an important stage where gene expression may be switched on or off
  - Translation** - when the genetic code is translated into proteins at ribosomes
  - The function of the protein product**, such as an enzyme, which will affect the phenotype

#### Gene expression diagram

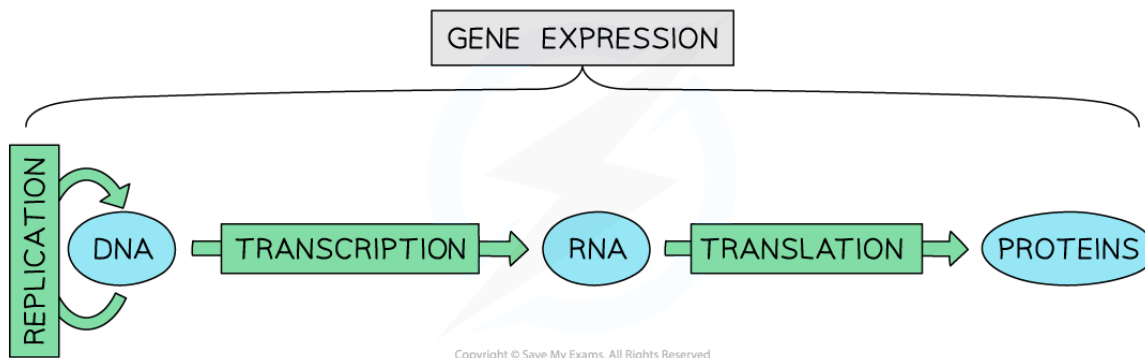

*Transcription, translation and the function of the protein product are the main stages of gene expression in organisms*



Your notes

## Regulating Transcription & Translation (HL)

### Regulation of Transcription

- Only some DNA sequences code for the production of polypeptides, these are called **coding sequences**
- Non-coding sequences produce functional RNA molecules like **transfer RNA (tRNA)** or are involved in the **regulation of gene expression** such as **enhancers** or **promoters**
  - The **promoter** is a non-coding sequence **located near a gene** whereas **enhancers** are non-coding regions of DNA that are usually found **further away** from a gene
  - The promoter and enhancer regions are not themselves transcribed
- Transcription factors** are a type of protein molecule that **bind to the promoter or enhancer sequences** to help initiate transcription
  - This helps RNA polymerase to attach to the promoter and result in an increase in the rate of transcription
  - These transcription factors regulate transcription and ensure that only the required genes are expressed in the correct cells, at the correct time and to the appropriate level depending on the specific needs of the cell
  - This is the most common way for cells to control gene expression

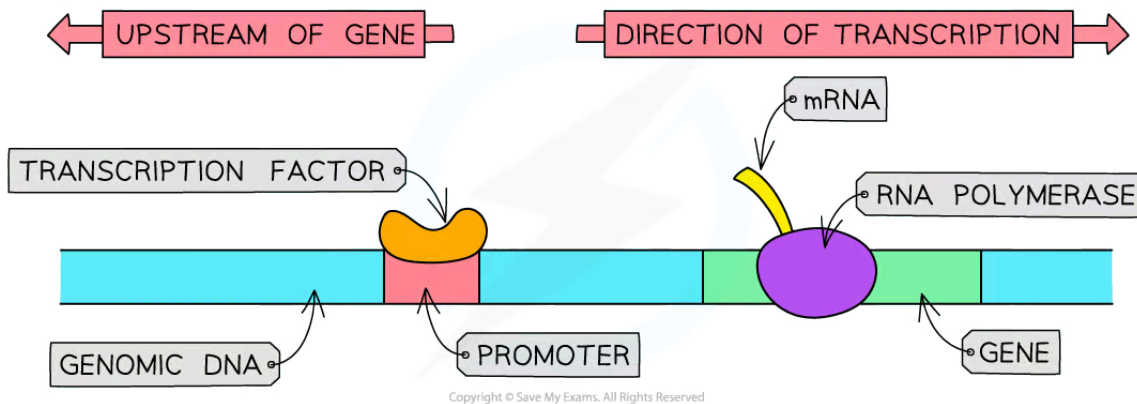

**A transcription factor binding to the promoter region of a gene which allows RNA polymerase to bind and for transcription to occur**

## Regulation of Translation

- Once mRNA molecules are synthesised during transcription, it is modified and transported to the ribosomes in the cytoplasm for translation
- Once translation of an mRNA molecule is complete, it will remain in the cytoplasm until it is broken down by enzymes called **nucleases**
  - In human cells, it may take anywhere from a few minutes to a couple of days before mRNA is broken down
  - **Degradation of mRNA** is a way for the cell to regulate the process of translation
  - This ensures that proteins are only synthesised when necessary and removes mRNA molecules which have already been translated

### Examiner Tip

Remember that the name of enzymes will often end with "-ase" or "-ases". Nucleases are enzymes that break down nucleic acids such as mRNA.



Your notes



Your notes

## Environment & Gene Expression (HL)

### Epigenesis & Differentiation in Cells

- **Epigenesis** is the development of differentiation patterns in the cells of multicellular organisms as it develops from a zygote
  - This is determined by the genome and patterns of gene expression in an organism
- **Epigenetics** is the **genetic control by factors other than** an individual's DNA sequence
  - It involves **heritable changes in gene function**, without changes to the DNA sequence
- In eukaryotic cells, nuclear DNA is wrapped around **proteins** called **histones** to form **chromatin**
- Chromatin can be **chemically modified** in different ways to alter gene expression
  - **Methylation** of DNA (chemical addition of a  $-CH_3$  group)
  - Histone modification of amino acid tails via
    - **Acetylation**: Acetyl groups are added to histones which allows transcription as it leads to the DNA becoming more loosely packed
    - **Methylation**: The addition of a  $-CH_3$  group
    - **Phosphorylation**: the addition of phosphate to an organic compound
- Such modifications are called **epigenetic tags** and collectively, all the epigenetic tags in an organism are called the **epigenome**
- Like the genome, the **epigenome is heritable**
  - Mounting evidence demonstrates that modifications to the epigenome in one generation **can be passed on** to the next generation at cellular or whole organism level
- The phenotype of an organism is determined by its genotype
  - Since the DNA sequence is not changed by epigenetic changes, the genotype of an organism will remain the same while the phenotype changes

#### Examiner Tip

Epigenetics can be distinguished from mutations, both of which lead to changes in the expressed characteristics of genes. Whilst mutations affect the genetic code itself e.g. by altered nucleotide sequences, epigenetics affect the way the code is read.

Think about an identical passage of text being read by two different people, one with perfect Queen's English and the other with a very strong regional dialect. Despite the text being the same (no mutations), the effect of the dialect (epigenetics) might alter the meaning of the piece drastically to a listener.

## Pattern of Gene Expression in Cells

### Differences between the genome, transcriptome and proteome of cells

- The **proteome** of an organism includes all the proteins synthesised within their cells and is determined by the genome
  - Each organism will have a unique proteome due to its unique set of genetic material
  - Different proteins are needed in different cell types, so only the genes responsible for expressing the correct proteins will be "switched on" at any particular time in a cell
  - This **avoids energy wastage** that would be caused by expressing all the genes in every cell
  - Therefore, the **genome** of each cell in an organism is the **same** while the **proteome varies**
- The range of mRNA transcripts produced within a cell or tissue type is known as its **transcriptome**
  - This in turn will be determined by the **pattern of gene expression** in the cell
  - The transcriptome will therefore result in **certain proteins** being synthesised



Your notes

**Proteome Diagram**

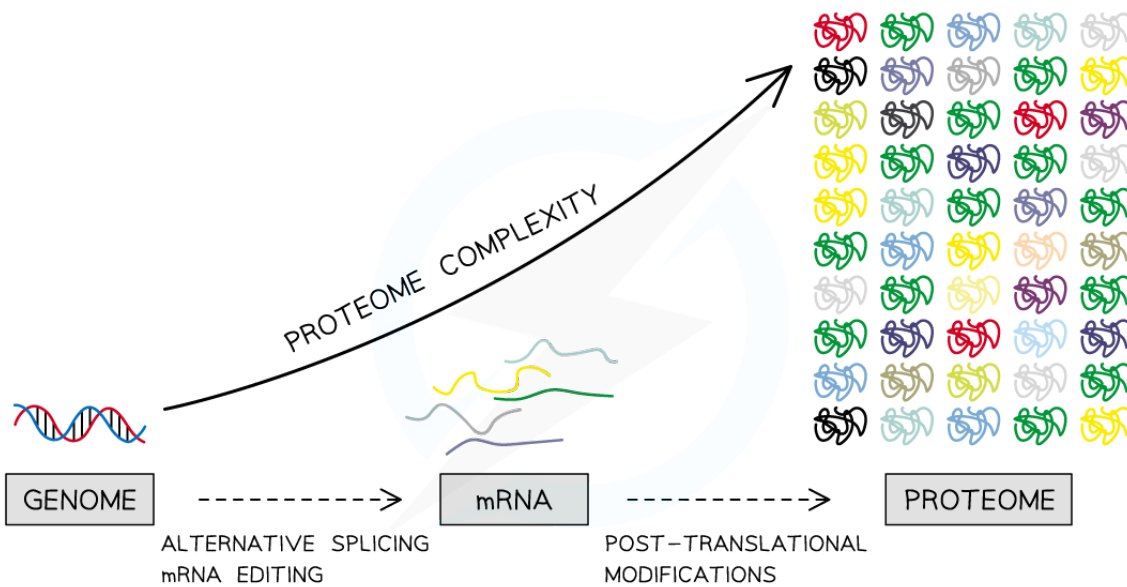

Copyright © Save My Exams. All Rights Reserved

*The relationship between the genome, transcriptome and proteome in cells*



Your notes

## Epigenetic Tags: Methylation

- Nucleosomes are the **structural unit of DNA packaging** in eukaryotes that **facilitate supercoiling**
- Within a nucleosome, DNA is wrapped around proteins called **histones**
- The tails of histones can be chemically modified which can influence **whether a gene will be expressed or not**
  - One way in which histones may be modified is by adding a **methyl** group to the amino acids of the protein
  - This can either **activate or deactivate genes** by making the gene more or less accessible to transcription factors
  - Chemicals (such as methyl or acetyl groups) that regulate gene expression are called **epigenetic tags**
- Methyl groups can also be **directly added to DNA** to change the activity of a gene

## Methylation of DNA

- DNA methylation commonly involves the direct addition of a **methyl** group ( $-\text{CH}_3$ ) to **cytosine** bases of the promoter region which can influence gene expression
- Methylation of DNA **suppresses** the transcription of the affected gene by **inhibiting** the binding of transcription factors
- Cells use this mechanism to lock genes in the 'off' position
- DNA methylation can be affected by many environmental, lifestyle or age-related factors



Your notes

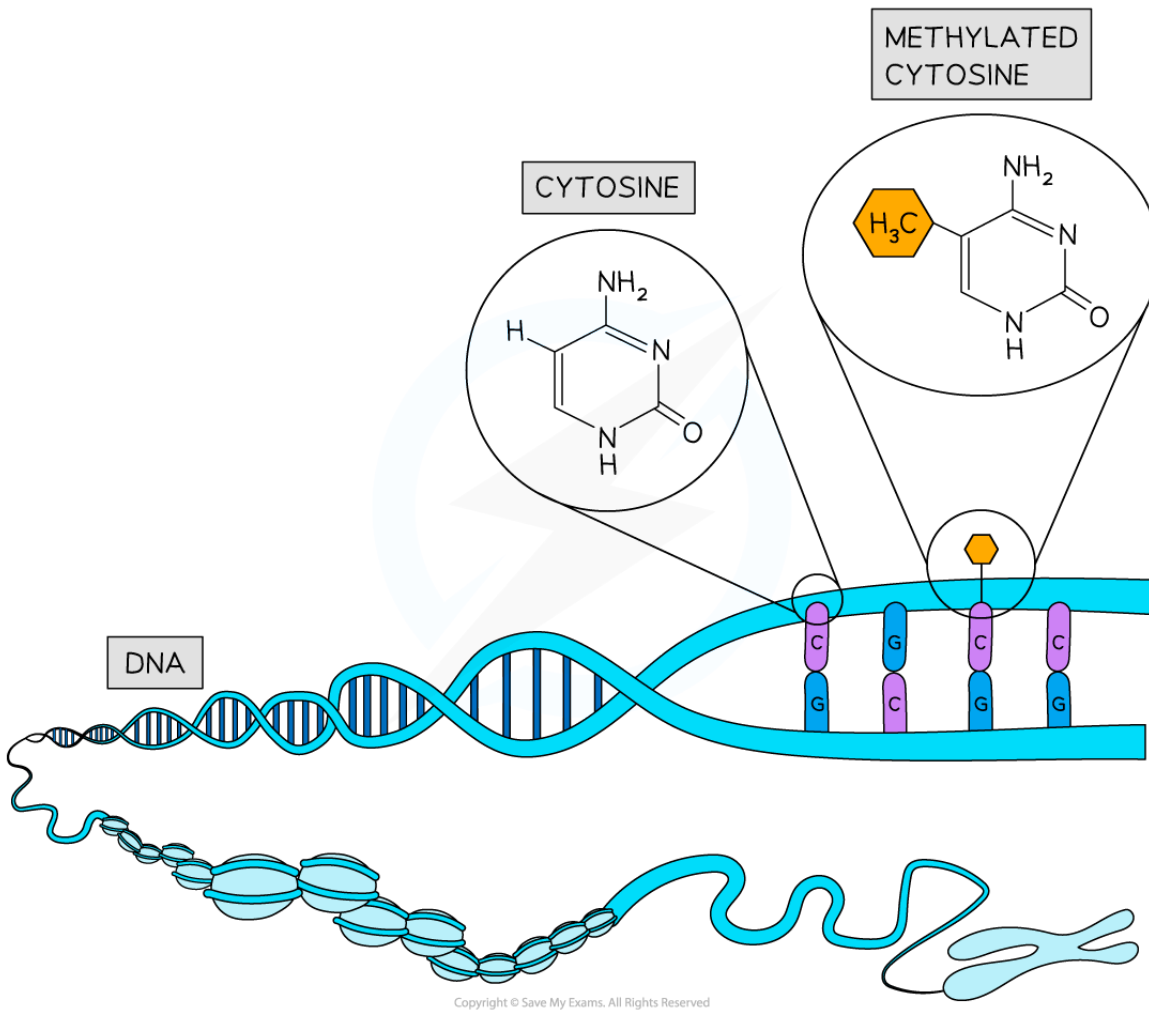

**Methylation of DNA at the promoter region is an example of how epigenetic tags may regulate gene expression**



## Epigenetic Inheritance

- When epigenetic tags (such as the methylation of DNA or histone tails) remain in place during mitosis or meiosis, then those modifications are passed on
  - In the case of **mitosis**, this results in **daughter cells** containing the same epigenetic modifications as the parent cells
  - **Meiosis** will form gametes containing these epigenetic tags which will then be passed on to the **offspring** that develop when these cells are fertilised
- The inheritance of these epigenetic tags is known as **epigenetic inheritance**
  - This means that phenotypic changes resulting from epigenetic modifications can be inherited without changes in the nucleotide sequence of DNA occurring
- If epigenetic tags are removed during mitosis or meiosis, then epigenetic inheritance cannot take place

### Examiner Tip

Remember that epigenetic tags (such as DNA methylation) will change the pattern of gene expression in a cell. This will determine which proteins are synthesised which will ultimately affect the phenotype of the cell or organism.



Your notes



Your notes

## Environment & Gene Expression: Examples (HL)

### Environment & Gene Expression: Examples

#### Effect of air pollution on gene expression

- Gene expression in cells may be affected by a range of **external conditions** e.g. diet, temperature, chemicals or air pollution
- Exposure to the chemicals in polluted air is of particular concern in urbanised or industrialised areas
  - Some of these substances may cause **damage to lung tissue** which results in the development of conditions such as asthma or chronic obstructive pulmonary disease
  - Air pollution may also have a negative impact on cardiovascular health
- Exposure to air pollution may **change methyl tags** on DNA or histone proteins, which will affect patterns of gene expression in cells
  - One effect of this may be increased levels of **inflammation** in the body and a higher risk of developing cardiovascular disease or certain pulmonary conditions
  - Inflammation in the respiratory system may result in **scarring** and the eventual **thickening of tissue** which may **decrease** the rate of diffusion of oxygen into the blood
- Suggested treatments to reduce the impact of air pollution include exercise and a diet high in B vitamins



Your notes

## Removing Epigenetic Tags from Ova & Sperm

- During egg and sperm development in mammals, most epigenetic tags are removed
  - This is to remove the changes made to **methylation patterns** caused by environmental influences and prevent them from being passed on to offspring
- Some of the epigenetic tags may be retained and passed on to the next generation by a process called **imprinting**
  - During imprinting, **epigenetic tags** may also be added to the DNA in sperm and egg cells
  - This results in only one copy of a gene being expressed (or 'switched on') while the other copy is suppressed (or 'switched off')
- Organisms will typically inherit two functional copies of a gene (one from each parent)
  - However, only **one** functional copy of an **imprinted gene** will be inherited by offspring since the other copy will be **silenced** by the presence of epigenetic tags
  - In sperm development, maternal genes are epigenetically silenced while paternal genes will be silenced during egg development

## Epigenetic origins of phenotypic differences in tignons and ligers

- Tignons and ligers are both the result of crossbreeding lions and tigers
  - Male tiger x female lion = **tignon**
    - Tignons are about the same size or even smaller than their parents
  - Male lion x female tiger = **liger**
    - Ligers are typically larger than both lions and tigers
- The phenotypic differences between tignons and ligers are due to **genetic imprinting**
- Lions and tigers have **different reproductive habits** which may affect the expression of the gene responsible for growth
  - Male lions will pass genes on that will encourage growth, while female lions have imprinted genes which will discourage growth
  - Neither male nor female tigers will pass down genes to discourage growth in their offspring
- When a male lion carrying genes that will encourage growth is crossed with a female tiger which does not have imprinted genes to discourage growth the resulting liger offspring will be able to grow **much larger** than its parents
- This is an example of how phenotypic differences between tignons and ligers have an epigenetic origin

### Epigenetic Inheritance Diagram



Your notes

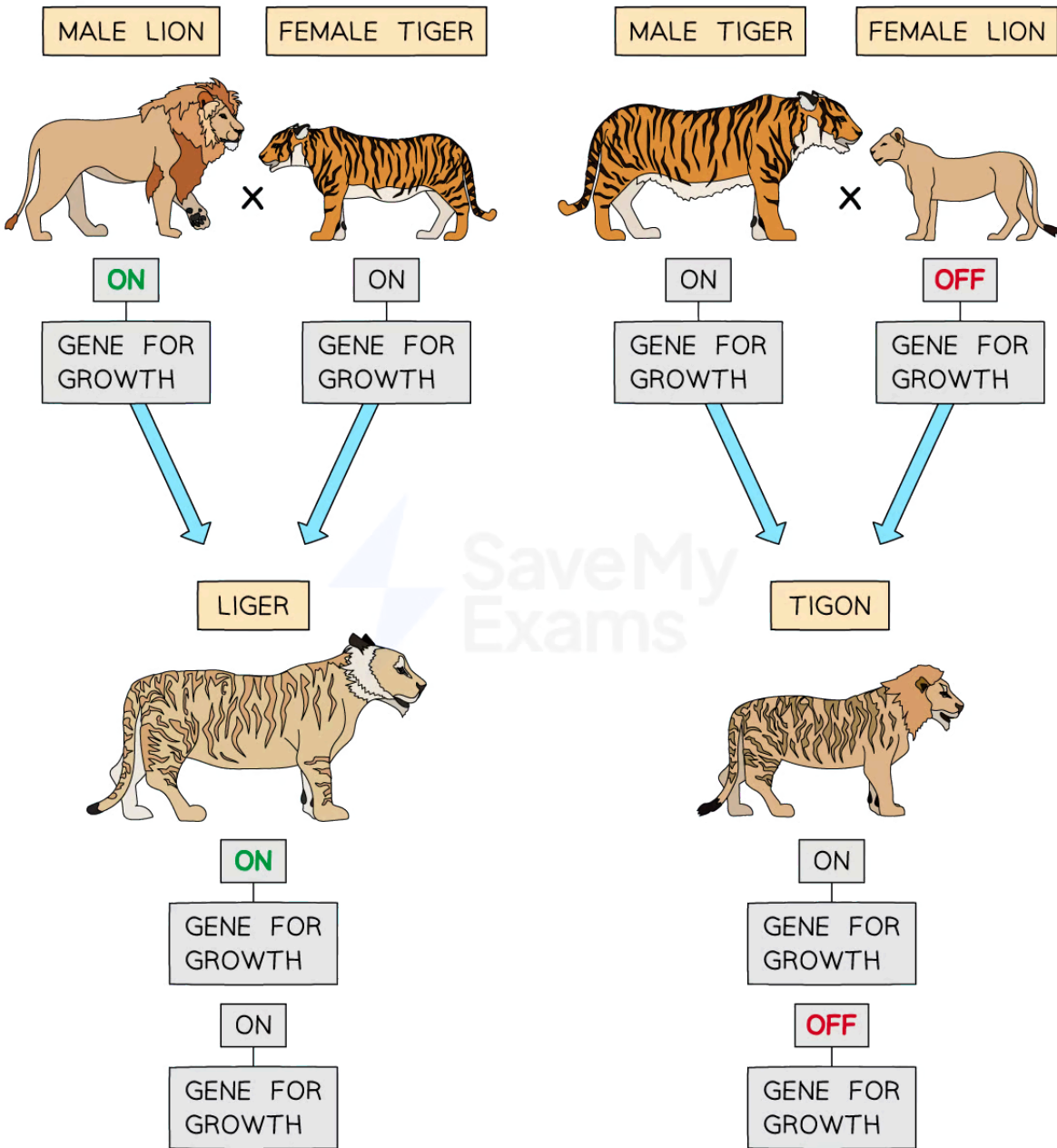

Copyright © Save My Exams. All Rights Reserved

*The phenotypic differences between tigons and ligers are due to different patterns of epigenetic inheritance*

## Monozygotic Twin Studies

- Variation between members of the same family may be due to several factors such as:
  - **Genetic** factors - differences in the genome lead to differences in the phenotype
  - **Environmental** factors - examples would include a change in skin colour due to sun exposure
  - A **combination of both** genetic and environmental factors - such as height and weight
- **Monozygotic twin studies** can be used to determine the contribution of genetics and the environment to phenotypic variation
  - **Monozygotic** twins are also called **identical twins** as they originate from the **same zygote** that splits into two during development
    - This leads to two individuals that are **genetically identical**
  - **Dizygotic** (or **non-identical**) twins are the result of **two different egg cells** that were fertilised at the same time
    - These twins are **genetically different** from one another
- Specific **phenotypic traits** can be measured **between** monozygotic twins and the results could indicate whether genetics or the environment are responsible for any measurable variation
  - E.g. if separated twins show traits that are similar, then there is a good probability that genes are responsible while significant differences in traits may indicate that environmental factors had an influence
- **Results** for monozygotic and dizygotic twin studies **can be compared** and used to determine the extent to which genetics or the environment are responsible for differences
  - E.g. if both monozygotic and dizygotic twins have similar traits, it is possible that it could be due to exposure to the same environmental factors
  - If monozygotic twins share more similarities with each other than with dizygotic twins, then it could be due to genetic factors that monozygotic twins have in common with each other
- Despite having the same genetic information, there are still **some variation** between monozygotic twins that could be attributed to **epigenetic changes** between them
  - These changes would include methylation of DNA or acetylation of histone tails



Your notes

### Monozygotic and Dizygotic Twins Diagram



Your notes

MONOZYGOTIC TWINS

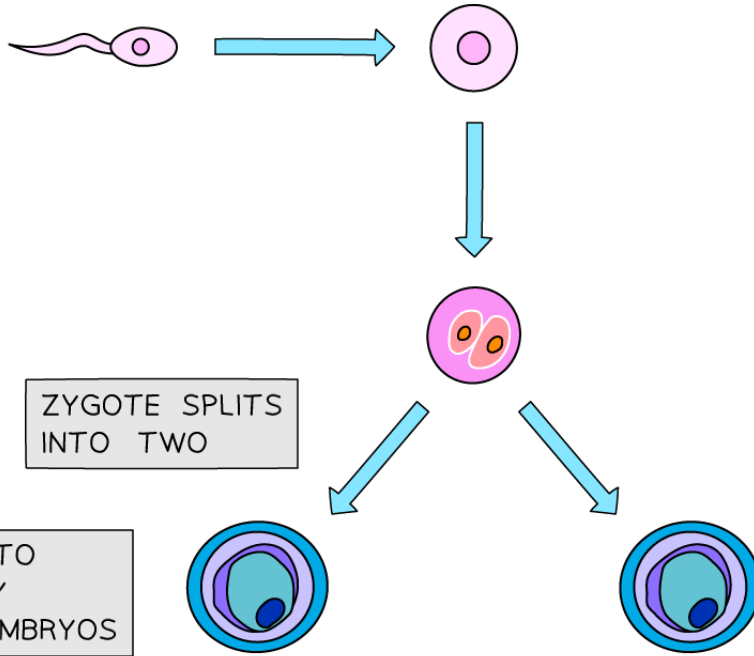

DIZYGOTIC TWINS

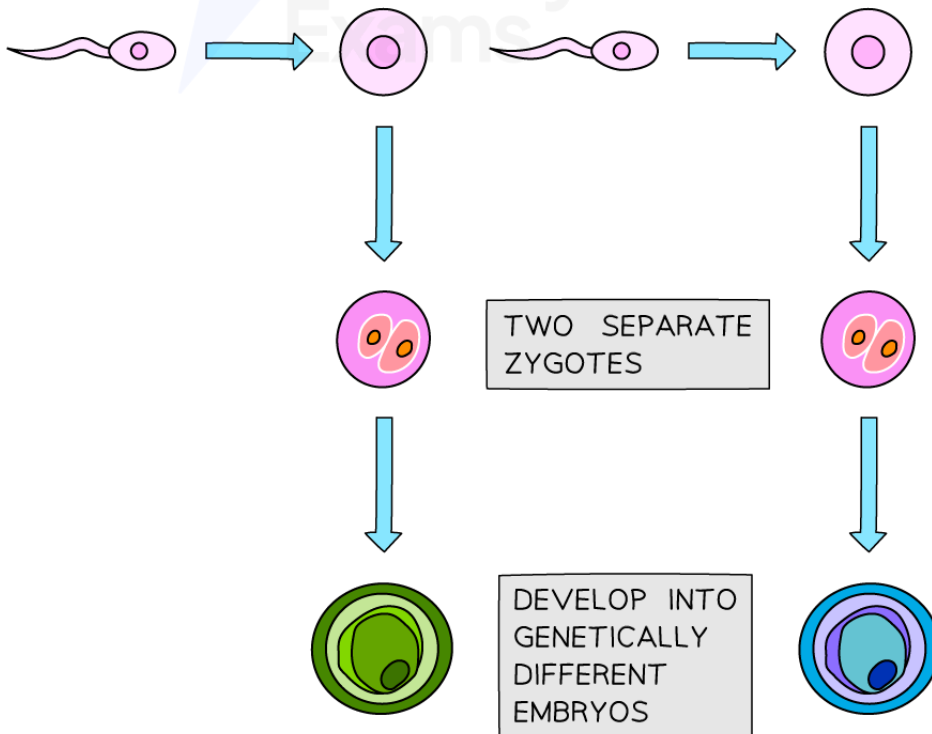

***Monozygotic twins are genetically identical because they develop from the same zygote whereas dizygotic twins are genetically distinct as they develop from two different zygotes***



Your notes



Your notes

## External Factors Impacting Gene Expression

### The effect of a hormone on gene expression

- Steroid hormones, such as oestrogen (also known as oestradiol), progesterone and testosterone, act as ligands that affect gene expression
  - This is covered in more detail under the subtopic of [Intracellular Receptors](#)

### The effect of lactose on gene expression in bacteria

- Regulatory genes control structural genes and their levels of protein production
  - Regulatory genes sometimes have control over several structural genes at once
  - Structural genes in **prokaryotes** can form an **operon**: a group or a cluster of genes that are controlled by the same promoter
    - The **lac operon** found in some bacteria is one of the most well-known of these
    - The lac operon controls the production of the enzyme **lactase** (also called  $\beta$ -galactosidase) and two other structural proteins
    - Lactase breaks down the substrate lactose so that it can be used as an energy source in the bacterial cell
    - It is an **inducible** enzyme that is **only synthesized when lactose is present**
    - This helps prevent the bacteria from wasting energy and materials

### Structure of the lac operon

- The components of the lac operon are found in the following order:
  - Promoter for structural genes
  - Operator
  - Structural gene **lacZ** that codes for **lactase**
  - Structural gene *lacY* that codes for permease (allows lactose into the cell)
  - Structural gene *lacA* that codes for transacetylase
- Located to the left (upstream) of the lac operon on the bacterium's DNA there is also the:
  - Promoter for regulatory gene
  - Regulatory gene **lacI** that codes for the **lac repressor protein**
- The lac repressor protein has **two binding sites** that allow it to bind to the **operator** in the lac operon and also to **lactose** (the **effector** molecule)
  - When it binds to the operator it **prevents the transcription** of the structural genes as RNA polymerase cannot attach to the promoter
  - When it binds to lactose the shape of the repressor protein distorts and it can **no longer bind to the operator**

### Lac Operon Diagram





Your notes

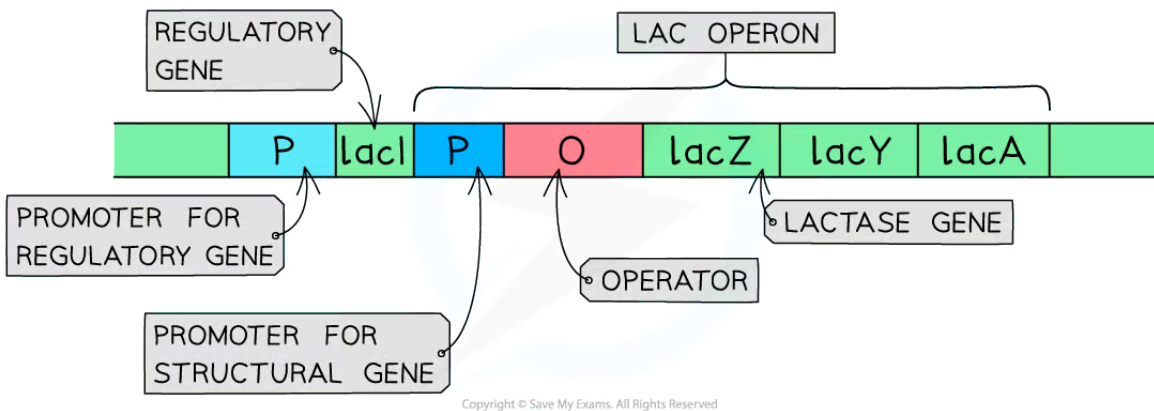

The components of the Lac operon along with the upstream regulatory gene and its associated promoter

### When lactose is absent

- The following processes take place when lactose is **absent** in the medium that the bacterium is growing in:
  - The regulatory gene is transcribed and translated to produce *lac* repressor protein
  - The *lac* **repressor protein binds to the operator** region upstream of *lacZ*
  - Due to the presence of the repressor protein, **RNA polymerase is unable to bind to the promoter region**
  - Transcription of the structural genes does not take place
  - No lactase enzyme is synthesized**

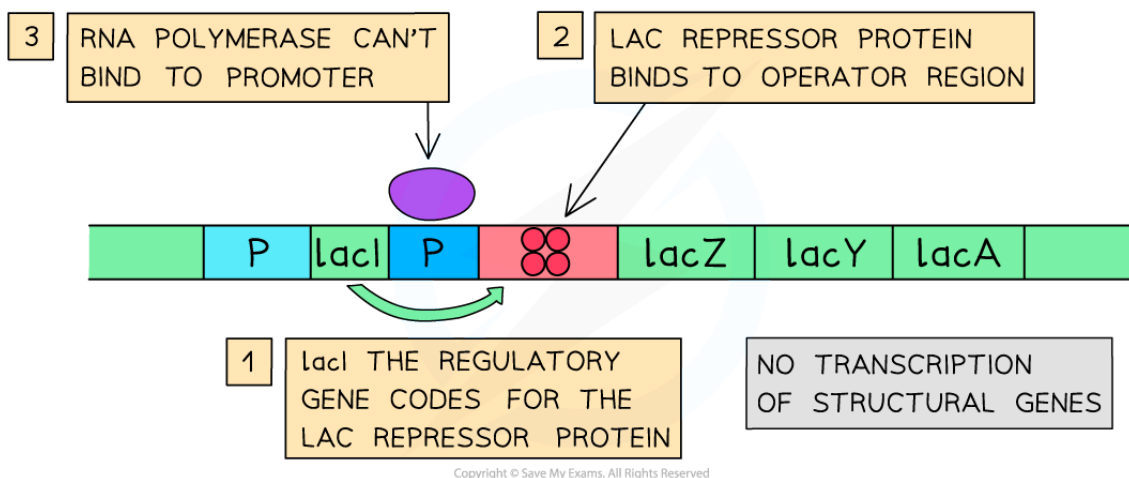

The repressor protein binding to the operator region of the Lac operon and preventing transcription of the structural gene



Your notes

## When lactose is present

- The following processes take place when lactose is present in the medium that the bacterium is growing in:
  - There is an uptake of lactose by the bacterium
  - The **lactose binds to the second binding site on the repressor** protein, distorting its shape so that it cannot bind to the operator site
  - **RNA polymerase is then able to bind to the promoter region** and transcription takes place
  - The mRNA from all three structural genes is translated
  - **Enzyme lactase is produced** and lactose can be broken down and used for energy by the bacterium

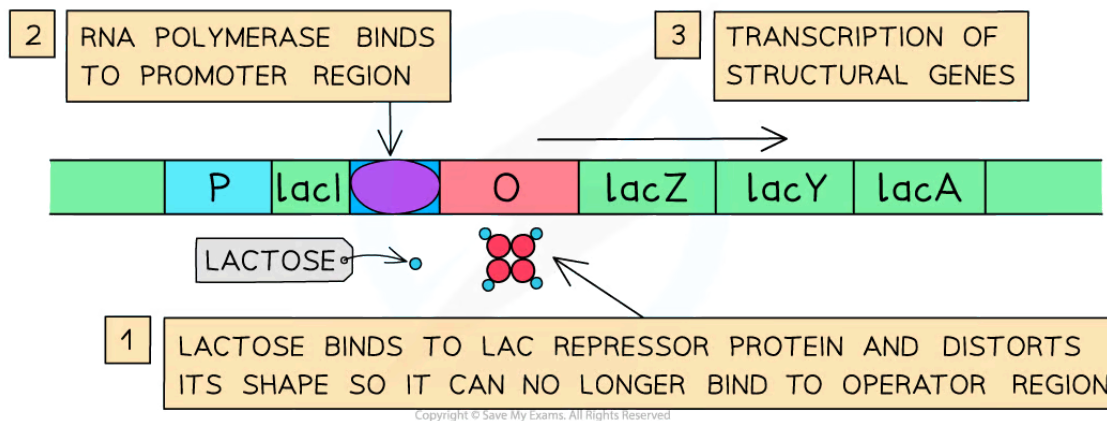

**Lactose binding to the repressor protein which frees up the operator region of the Lac operon so RNA polymerase can bind and begin transcription of the structural genes**