

# HL IB Chemistry



Your notes

## Functional Groups: Classification of Organic Compounds

### Contents

- \* Representing Formulas of Organic Compounds
- \* Functional Groups
- \* Homologous Series
- \* IUPAC Nomenclature
- \* Structural Isomers
- \* Cis-Trans Isomers (HL)
- \* Enantiomers (HL)
- \* Mass Spectrometry (MS) Fragmentation Patterns (HL)
- \* Infrared Spectra (IR) Interpretation (HL)
- \* Proton NMR Spectroscopy (HL)
- \* Peak Splitting in Proton NMR (HL)
- \* Structural Analysis of Molecules (HL)



Your notes

## Representing Formulas of Organic Compounds

### Representing Formulas of Organic Compounds

- Organic compounds can be represented using a variety of different formulae:
  - Empirical
  - Molecular
  - Structural
  - Condensed Structural
  - Skeletal
  - Stereochemical

#### Empirical formula

- What is **empirical formula**?
  - The empirical formula shows the **simplest whole-number ratio of the atoms in a molecule**
- For example, if you were asked "What is the empirical formula of hydrogen peroxide?"
  - Hydrogen peroxide is  $\text{H}_2\text{O}_2$
  - This shows that there are two hydrogen atoms and two oxygen atoms, but this is not the simplest whole-number ratio
  - Since there is a factor of 2, the empirical formula is HO

#### Molecular formula

- What is **molecular formula**?
  - The molecular formula shows the **actual number of atoms in a molecule**
- For example:

##### The molecular formulae of butane and butene

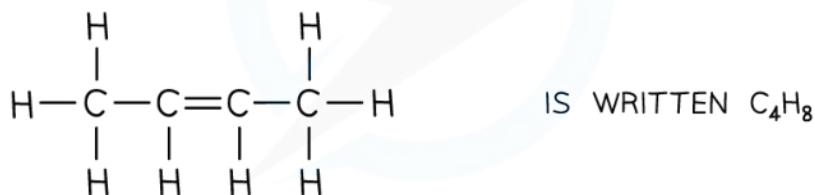
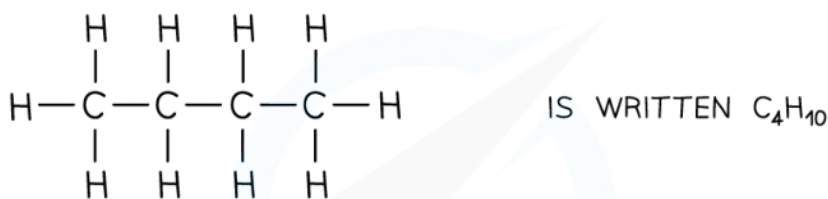

Copyright © Save My Exams. All Rights Reserved

*The molecular formula of butane is  $\text{C}_4\text{H}_{10}$  because it contains four carbon and ten hydrogen atoms, while butene is  $\text{C}_4\text{H}_8$  because it contains four carbon and eight hydrogen atoms*



Your notes

### Worked example

Deduce the molecular and empirical formula of the following compounds:

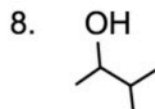
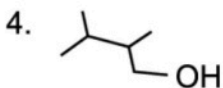
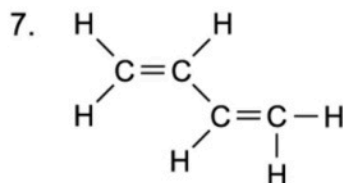
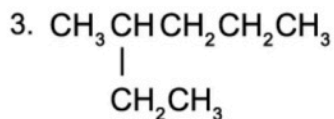
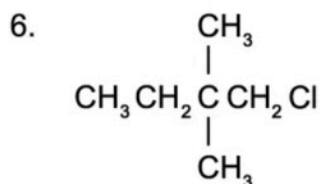
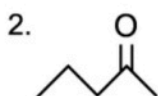
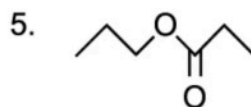
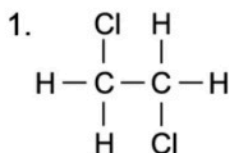
**Answers:**
**Answer 1:**

- Molecular formula =  $\text{C}_2\text{H}_4\text{Cl}_2$
- Empirical formula =  $\text{CH}_2\text{Cl}$

**Answer 2:**

- Molecular formula =  $\text{C}_5\text{H}_{10}\text{O}$
- Empirical formula =  $\text{C}_5\text{H}_{10}\text{O}$

**Answer 3:**

- Molecular formula =  $\text{C}_7\text{H}_{16}$

**Answer 5:**

- Molecular formula =  $\text{C}_6\text{H}_{12}\text{O}_2$
- Empirical formula =  $\text{C}_3\text{H}_6\text{O}$

**Answer 6:**

- Molecular formula =  $\text{C}_6\text{H}_{13}\text{Cl}$
- Empirical formula =  $\text{C}_6\text{H}_{13}\text{Cl}$

**Answer 7:**

- Molecular formula =  $\text{C}_4\text{H}_6$

- Empirical formula =  $C_7H_{16}$

- Empirical formula =  $C_2H_3$

**Answer 4:**

- Molecular formula =  $C_6H_{14}O$
- Empirical formula =  $C_6H_{14}O$

**Answer 8:**

- Molecular formula =  $C_5H_{12}O$
- Empirical formula =  $C_5H_{12}O$



Your notes

## Structural formula

- The **structural formula** shows the spatial arrangement of all the atoms and bonds in a molecule
  - This is also known as the **displayed formula** or **graphical formula**
- For example:

### The structural formula of 2-methylbutane

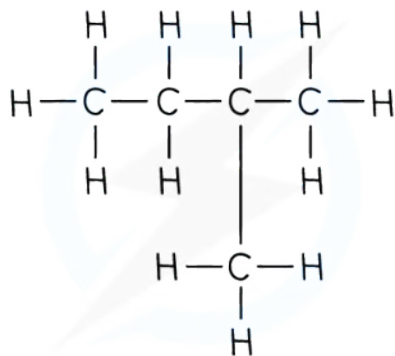

Copyright © Save My Exams. All Rights Reserved

### The structural formula shows all of the bonds between all atoms

- In a **condensed structural formula**, enough information is shown to make the structure clear, but most of the actual covalent bonds are omitted
- Only important bonds are always shown, such as double and triple bonds
- Identical groups can be bracketed together:

### Representing the condensed structural formula of straight-chain alkanes

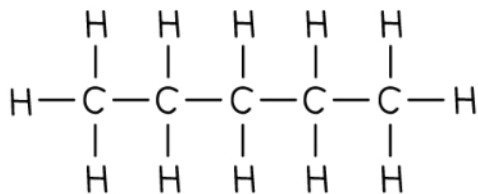

IS REPRESENTED AS  $CH_3CH_2CH_2CH_2CH_3$   
OR  $CH_3(CH_2)_3CH_3$

Copyright © Save My Exams. All Rights Reserved

The full structural formula shows all bonds, while the condensed structural formula indicates the structure of the compound



Your notes

- Side groups are shown using brackets:

### Representing the condensed structural formula of branched chain alkanes

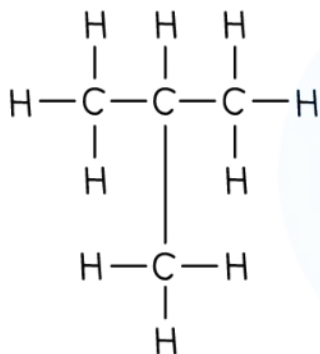

IS REPRESENTED AS  $\text{CH}_3\text{CH}(\text{CH}_3)\text{CH}_3$   
OR  $\text{CH}_3\text{CH}(\text{CH}_3)_2$

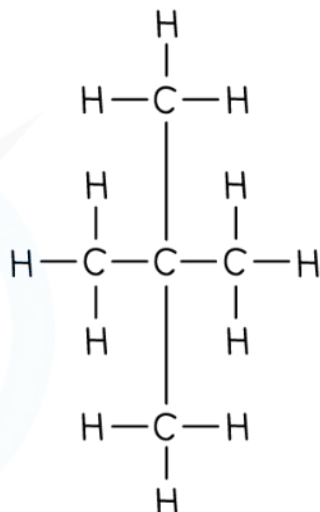

IS REPRESENTED AS  $\text{CH}_3\text{C}(\text{CH}_3)_2\text{CH}_3$   
OR  $\text{CH}_3\text{C}(\text{CH}_3)_3$  OR  $\text{C}(\text{CH}_3)_4$

Copyright © Save My Exams. All Rights Reserved

**The full structural formula shows all bonds, while the condensed structural formula includes functional groups in brackets to indicate the structure of the compound**

- Specific bonds such as double (or triple) bonds are not always shown
  - It can be expected for you to deduce if there is a double (or triple) bond within the structure from the number of hydrogens attached to the carbon atoms

### Representing the condensed structural formula of alkenes

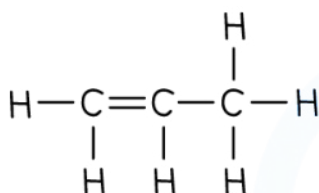

IS REPRESENTED AS  $\text{CH}_2=\text{CHCH}_3$

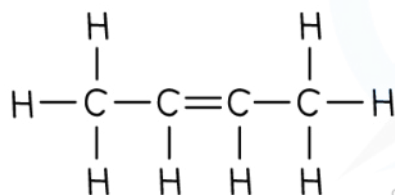

IS REPRESENTED AS  $\text{CH}_3\text{CH}=\text{CHCH}_3$

Copyright © Save My Exams. All Rights Reserved

**The condensed structural formula of an alkene can be shown with or without the carbon-carbon double bond**

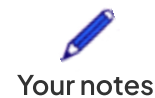

## Skeletal formula

- A **skeletal formula** is a simplified displayed formula with:
  - All of the carbon-carbon bonds are represented by lines
    - The end of each line and the point where two lines meet is a carbon atom
  - Most of the hydrogen atoms are removed except hydrogen atoms that are part of a functional group, e.g. OH
  - For more information about the different functional groups, see our revision not on [Functional Groups](#)
- For example:

**The skeletal formula of propane, but-2-ene and ethanoic acid**

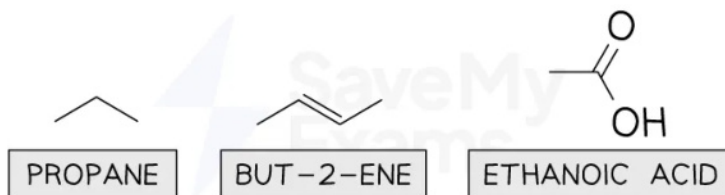

Copyright © Save My Exams. All Rights Reserved

**Skeletal formulae do not show carbon atoms and only show hydrogen atoms that are contained within a functional group**

- What is the skeletal formula of methane?
  - There is no skeletal formula for methane
  - This is because carbon-carbon bonds are replaced with lines, which means that two carbon atoms are required
  - Some answers suggest the skeletal formula of methane is a dot, but this is unlikely as it could easily be mistaken or confused with the symbol for a free radical
  - Other answers incorrectly suggest that the skeletal formula of methane is a carbon atom showing all four carbon-hydrogen bonds, but this is a structural formula



Your notes

### Worked example

Draw the skeletal formula of the following molecules:

1.  $\text{CH}_3(\text{CH}_2)_3\text{OH}$
2.  $(\text{CH}_3)_2\text{CHCH}_2\text{OH}$
3.  $\text{CH}_3\text{CH}_2\text{OCH}_2\text{CH}_3$

**Answers:**

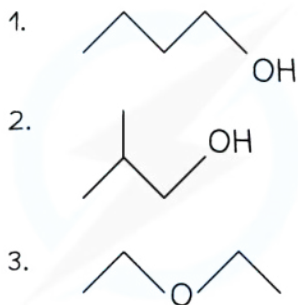

Copyright © Save My Exams. All Rights Reserved



Your notes

### Worked example

Draw the full structural formula of the following molecules:

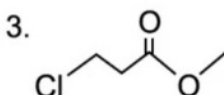
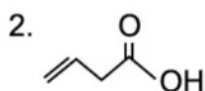

Answers:

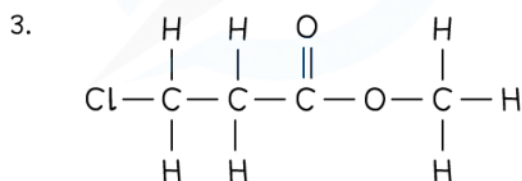
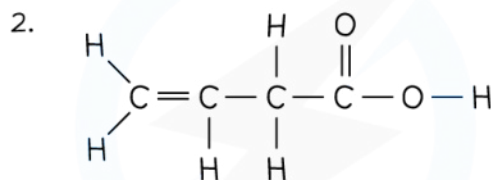
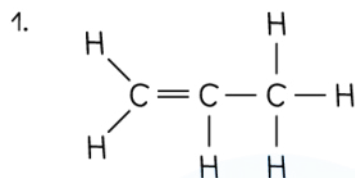

Copyright © Save My Exams. All Rights Reserved

## Stereochemical formula

- A **stereochemical formula** is a formula that attempts to show the relative positions and three-dimensional geometry of atoms and groups of atoms around a **chiral carbon**
  - For more information about chiral carbons, see our revision note on [Enantiomers](#)
- Stereochemical formulae follow a standard convention:
  - Bonds in the plane of the paper are drawn as solid lines
  - Bonds coming forward out of the plane (towards you) are drawn as a solid wedge
  - Bonds going backward out of the plane (away from you) are drawn as a dashed wedge

### Diagram of the different bonds in a stereochemical formula



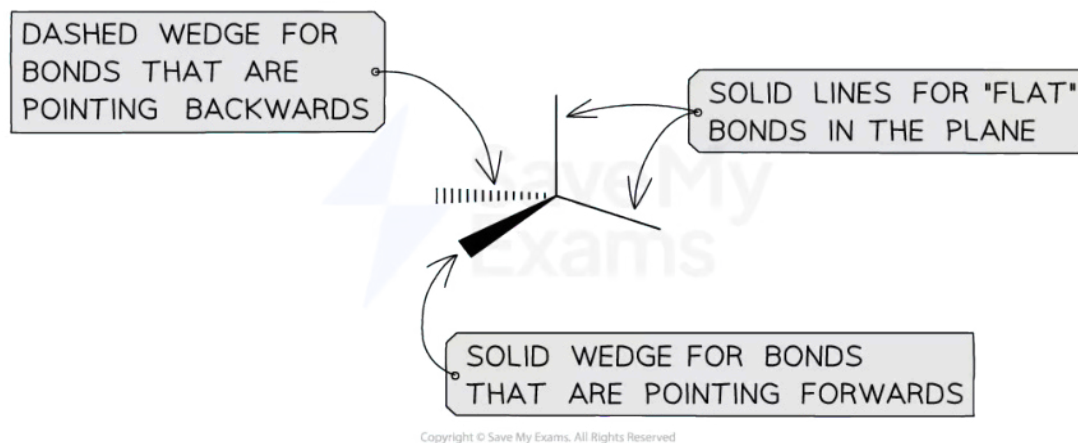

**Stereochemical formulae use solid lines, solid wedges and dashed wedges to illustrate if the bonds are in the plane of the paper, forwards from the paper or backwards from the paper**

- Since the central, chiral carbon has four bonds / electron domains to different atoms or groups of atoms, the shape is tetrahedral with bond angles of  $109.5^\circ$ 
  - For more information about the shapes and bond angles of molecules, see our revision note on [Shapes of Molecules](#)



Your notes

## Functional Groups

### Functional Groups

#### What are functional groups in organic chemistry?

- Functional groups are atoms or groups of atoms that are found in organic compounds
- They give organic compounds their characteristic physical and chemical properties
- Organic compounds that contain the same functional group belong to the same **class**
  - Careful:** This should not be confused with belonging to the same homologous series
- For example:
  - The class of organic compounds called the alkenes all contain the carbon-carbon double bond – **C=C**– functional group
  - The class of organic compounds called the aldehydes all contain the –**CHO** functional group

Classes of organic compounds table

Class	Functional group name	Functional group formula	IUAC prefix– or –suffix	Example
alkane	alkyl	–	–ane	$\begin{array}{c} \text{H} & \text{H} \\   &   \\ \text{H}-\text{C} & -\text{C}-\text{H} \\   &   \\ \text{H} & \text{H} \end{array}$ ethane
alkene	alkenyl	$\begin{array}{c} \diagdown & \diagup \\ & \text{C}=\text{C} \\ \diagup & \diagdown \end{array}$	–ene	$\begin{array}{c} \text{H} & & \text{H} \\ & \diagdown & / \\ & \text{C}=\text{C} \\ & / & \diagdown \\ \text{H} & & \text{H} \end{array}$ ethene
alkyne	alkynyl	–C≡C–	–yne	$\text{H}-\text{C}\equiv\text{C}-\text{H}$ ethyne
halogenoalkane	halogeno	F– Cl– Br– I–	fluoro– chloro– bromo– iodo–	$\begin{array}{c} \text{H} & \text{H} \\   &   \\ \text{H}-\text{C} & -\text{C}-\text{X} \\   &   \\ \text{H} & \text{H} \end{array}$

				if X = F, fluoroethane
alcohol	hydroxyl	$\text{—OH}$	hydroxy- -ol	$\begin{array}{c} \text{H} \quad \text{H} \\   \quad   \\ \text{H—C—C—OH} \\   \quad   \\ \text{H} \quad \text{H} \end{array}$ ethanol
aldehyde	carbonyl (aldehyde)	$\begin{array}{c} \text{O} \\ // \\ \text{—C} \\   \\ \text{H} \end{array}$	-al	$\begin{array}{c} \text{H} \quad \text{O} \\   \quad // \\ \text{H—C—C} \\   \quad   \\ \text{H} \quad \text{H} \end{array}$ ethanal
ketone	carbonyl (ketone)	$\begin{array}{c} \text{O} \\ // \\ \text{—C—} \end{array}$	-one	$\begin{array}{c} \text{H} \quad \text{O} \quad \text{H} \\   \quad    \quad   \\ \text{H—C—C—C—H} \\   \quad \quad   \\ \text{H} \quad \quad \text{H} \end{array}$ propanone
carboxylic acid	carboxyl (acid)	$\begin{array}{c} \text{O} \\ // \\ \text{—C} \\   \\ \text{OH} \end{array}$	-oic acid	$\begin{array}{c} \text{H} \quad \text{O} \\   \quad // \\ \text{H—C—C} \\   \quad   \\ \text{H} \quad \text{OH} \end{array}$ ethanoic acid
ether	alkoxy	$\text{—O—}$	-	$\begin{array}{c} \text{H} \quad \text{H} \quad \text{H} \quad \text{H} \\   \quad   \quad   \quad   \\ \text{H—C—C—O—C—C—H} \\   \quad   \quad   \quad   \\ \text{H} \quad \text{H} \quad \text{H} \quad \text{H} \end{array}$ ethoxyethane
amine	amino	$\text{—NH}_2$	-amine	$\begin{array}{c} \text{H} \quad \text{H} \\   \quad   \\ \text{H—C—C—NH}_2 \\   \quad   \\ \text{H} \quad \text{H} \end{array}$ ethanamine
amide	amido	$\begin{array}{c} \text{O} \\ // \\ \text{—C} \\   \\ \text{NH}_2 \end{array}$	-amide	$\begin{array}{c} \text{H} \quad \text{O} \\   \quad // \\ \text{H—C—C} \\   \quad   \\ \text{H} \quad \text{NH}_2 \end{array}$ ethanamide

  
 Your notes

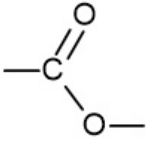
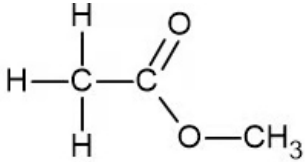
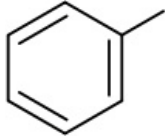
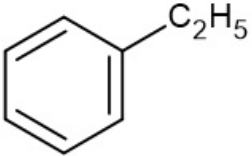
ester	ester (carboxyl)		-oate	 methyl ethanoate
aromatics*	phenyl		phenyl- -benzene	 phenylethene ethylbenzene

\* The specification does not require specific knowledge of aromatics / arenes as a class of organic compound



Your notes

## Homologous Series

### Homologous Series

- **Organic chemistry** is the chemistry of carbon compounds
- Carbon forms a vast number of compounds because it can form strong covalent bonds with itself
- This enables it to form long chains of carbon atoms, and hence an almost infinite variety of carbon compounds are known
- The tendency of identical atoms to form covalent bonds with each other and hence form chains is known as **catenation**

#### Examples of catenation using carbon

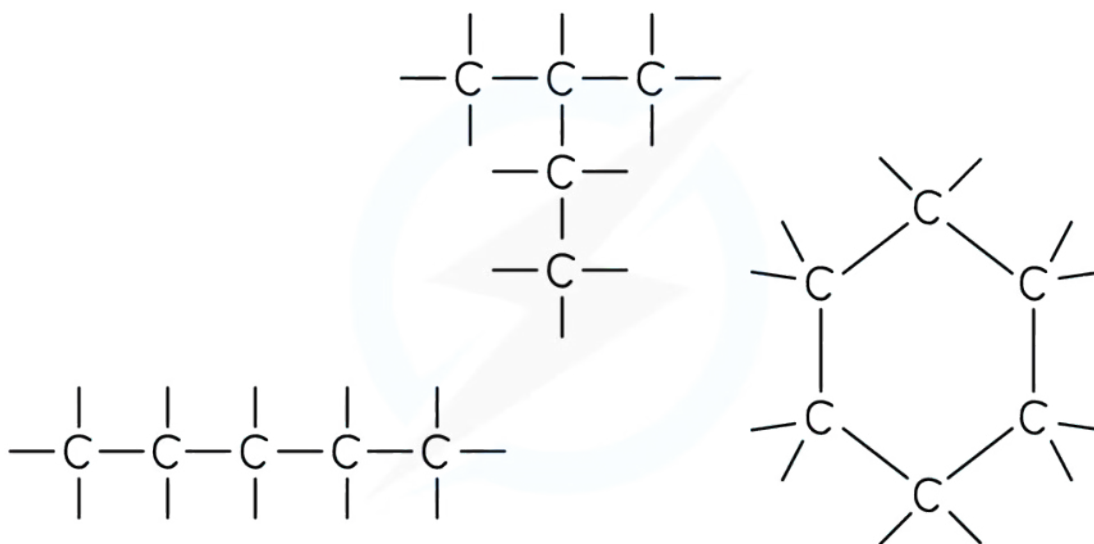

Copyright © Save My Exams. All Rights Reserved

#### **Catenation in carbon allows an almost infinite variety of chains, branches and rings**

- Carbon always forms four covalent bonds which can be single, double or triple bonds
- A **functional group** is a specific atom or group of atoms which confer certain physical and chemical properties onto the molecule
- Organic molecules are classified by the dominant **functional group** on the molecule

### What is a homologous series?

- Organic compounds with the same functional group, but a different number of carbon atoms, are said to belong to the same **homologous series**
- One definition of a homologous series is:  
*A family of similar compounds, having the same functional group, and so similar chemical properties*

- Every time a carbon atom is added to the chain, two hydrogen atoms are also added



Your notes

### Homologous Series of Alkanes Table

Name of alkane	Number of carbons	Chemical formula	Melting point / °C	State at room temperature	Boiling point / °C
Methane	1	CH <sub>4</sub>	-182	gas	-162
Ethane	2	C <sub>2</sub> H <sub>6</sub>	-183	gas	-89
Propane	3	C <sub>3</sub> H <sub>8</sub>	-188	gas	-42
Butane	4	C <sub>4</sub> H <sub>10</sub>	-138	gas	-1
Pentane	5	C <sub>5</sub> H <sub>12</sub>	-130	liquid	36

### The characteristics of a homologous series

- The features of a homologous series are:
  - Each member has the **same functional group**
  - Each member has the **same general formula**
  - Each member has **similar chemical properties**
  - Each member **differs by -CH<sub>2</sub>-**
  - Members have **gradually changing physical properties**, for example, boiling point, melting point and density
- As a homologous series is ascended, the size of the molecule increases
  - This has an effect on the physical properties, such as boiling point and density

### General formulae of different homologous series

- Each homologous series can be described by a general formula

#### General formulae of homologous series table

Homologous series	General formula	Example
alkanes	C <sub>n</sub> H <sub>2n+2</sub>	Propane C <sub>3</sub> H <sub>8</sub>
alkenes**	C <sub>n</sub> H <sub>2n</sub>	Propene C <sub>3</sub> H <sub>6</sub>



<b>alkynes</b>	$C_nH_{2n-2}$	Propyne $C_3H_4$
<b>halogenoalkanes</b>	$C_nH_{2n+1}X$	Chloropropane $C_3H_7Cl$
<b>alcohols</b>	$C_nH_{2n+1}OH$	Propanol $C_3H_7OH$
<b>aldehydes</b>	$C_nH_{2n}O$ (usually written as R-CHO)	Propanal $C_3H_6O$
<b>ketones</b>	$C_nH_{2n}O$ (usually written as R-(C=O)-R)	Propanal $C_3H_6O$
<b>carboxylic acids</b>	$C_nH_{2n+1}COOH$ (usually written as R-COOH)	Propanoic acid $C_2H_5COOH$
<b>ethers</b>	$C_nH_{2n+2}O$ (usually written as R-O-R)	Methoxymethane $CH_3OCH_3$
<b>amines</b>	$C_nH_{2n+1}NH_2$	Propylamine $C_3H_7NH_2$
<b>amides</b>	$C_nH_{2n+1}NO$ (usually written as R-CONH-R')	N-methylethanamide $CH_3CONHCH_3$
<b>esters</b>	$C_nH_{2n}O_2$ (usually written as R-COO-R')	Methyl methanoate $HCOOCH_3$

\*\* Ethene is the smallest possible alkene as a minimum of two carbons are required to form the carbon-carbon double bond

## Physical Trends in a Homologous Series

- Since successive members of a homologous series differ by a single  $\text{-CH}_2\text{-}$  group, they show a trend in physical properties



Your notes

Boiling point graph for four different homologous series

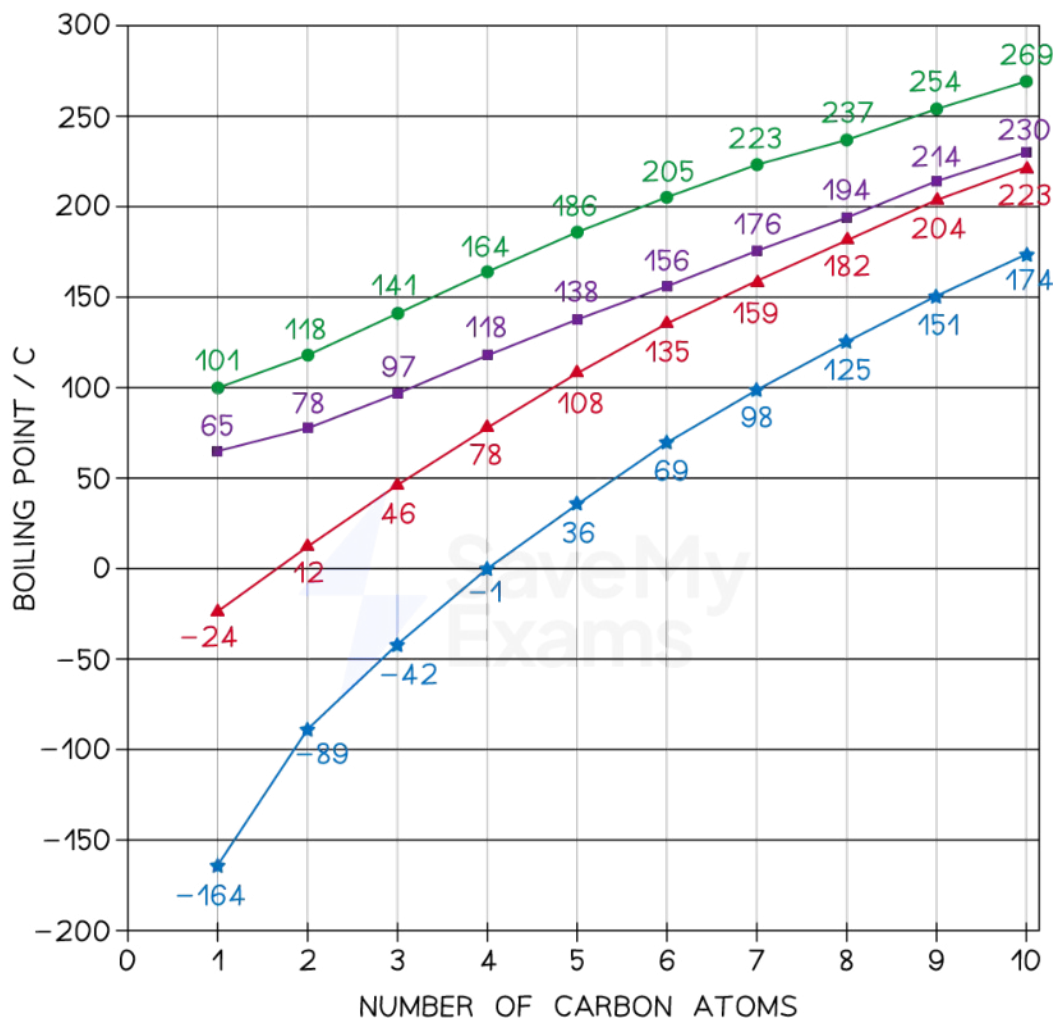

KEY: ★ = ALKANES      ▲ = CHLOROALKANES  
 ■ = PRIMARY ALCOHOLS      ● = CARBOXYLIC ACIDS

Copyright © Save My Exams. All Rights Reserved

*As the number of carbons in the straight-chain molecule increases, the boiling point increases*

- The broad trend is that **boiling point increases** with increased molecular size
- Each additional  $\text{-CH}_2\text{-}$  (called the **homologous increment**) adds 8 more electrons to the molecule



- This increases the strength of the **London dispersion forces**, which leads to a higher boiling point
- Similar trends are seen with other physical properties such as melting point, density and viscosity
- These trends are followed in other homologous series



Your notes



Your notes

## IUPAC Nomenclature

### IUPAC Nomenclature

- IUPAC or **systematic nomenclature** can be used to name organic compounds and therefore make it easier to refer to them

### Naming hydrocarbons

- Hydrocarbons** are compounds containing hydrogen and carbon only
- There are four families of hydrocarbons you should know:
  - Alkanes
  - Alkenes
  - Alkynes
  - Arenes

### Naming alkanes

- Alkanes** have the general molecular formula  $C_nH_{2n+2}$ 
  - They contain only single bonds and are said to be saturated
- Alkanes** are named using the nomenclature rule **alk + ane**
  - The **alk** depends on the number of carbons as outlined in the following table
- The **alkanes** provide the basis of the naming system and the **stem** of each name indicates how many carbon atoms are in the **longest chain** in one molecule of the compound

**IUPAC system of naming alkanes table**

Number of carbon atoms	Molecular formula of straight-chain alkane	IUPAC name of alkane	Stem used in naming
1	CH <sub>4</sub>	methane	meth-
2	C <sub>2</sub> H <sub>6</sub>	ethane	eth-
3	C <sub>3</sub> H <sub>8</sub>	propane	prop-
4	C <sub>4</sub> H <sub>10</sub>	butane	but-
5	C <sub>5</sub> H <sub>12</sub>	pentane	pent-
6	C <sub>6</sub> H <sub>14</sub>	hexane	hex-
7	C <sub>7</sub> H <sub>16</sub>	heptane	hept-



8	C <sub>8</sub> H <sub>18</sub>	octane	oct-
9	C <sub>9</sub> H <sub>20</sub>	nonane	non-
10	C <sub>10</sub> H <sub>22</sub>	decane	dec-

### Examiner Tip

Although the table shows up to 10 carbons for reference, in your IB Chemistry exam you are only required to name molecules with up to 6 carbons

- If there are any side-chains or functional groups present, then the position of these groups is indicated by numbering the carbon atoms in the longest chain starting at the end that gives the lowest possible numbers in the name
- The hydrocarbon **side chain** is shown in **brackets** in the structural formula



- The side-chain is named by adding '-yl' to the normal alkane **stem**
- This type of group is called an **alkyl** group

### Naming organic compounds with one alkyl side chain

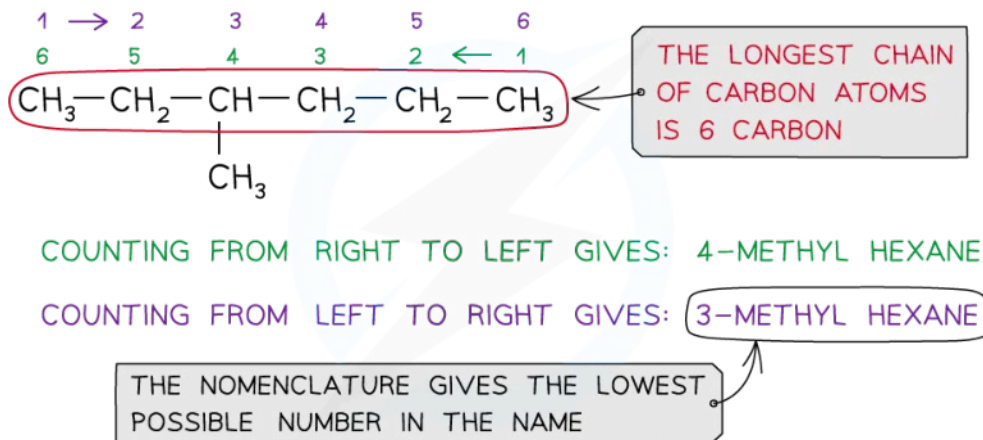

Copyright © Save My Exams. All Rights Reserved

**The longest chain provides the main name and the side chain is shown as a numbered alkyl prefix**

- If there are more than one of the same alkyl side chain or functional groups, **di-** (for two), **tri-** (for three) or **tetra-** (for four) is added in front of its name



Your notes

- The adjacent **numbers** have a comma between them
- **Numbers** are separated from **words** by a hyphen

### Naming organic compounds with multiple, identical side chains

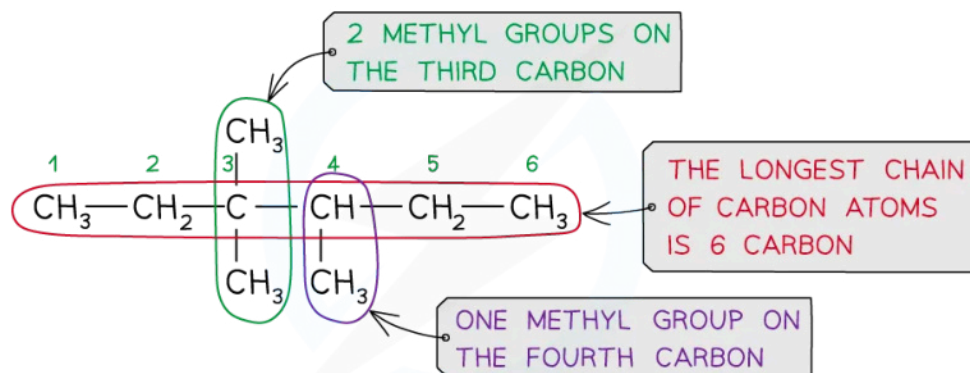

3, 3, 4 - TRIMETHYL HEXANE

Copyright © Save My Exams. All Rights Reserved

*The longest chain still provides the main name and the side chains are shown as numbered alkyl prefixes*

- If there is more than one type of alkyl side chain, the same numbering system applies but the different side chains are listed in alphabetic order

### Naming organic compounds with multiple, different side chains

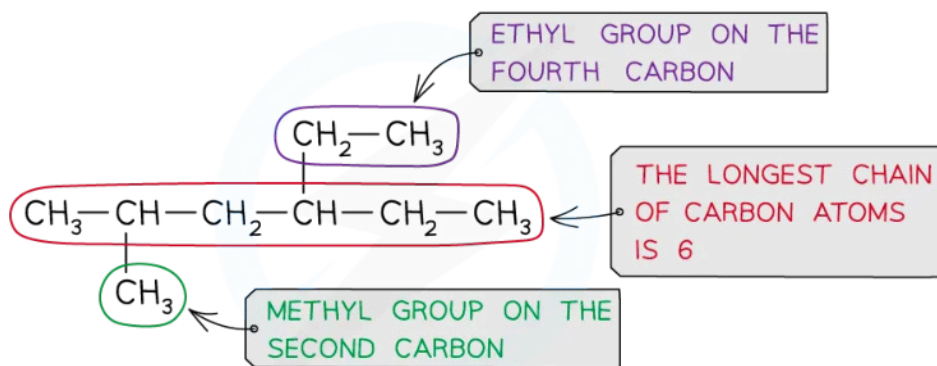

4-ETHYL-2-METHYL HEXANE

Copyright © Save My Exams. All Rights Reserved

*The longest chain still provides the main name and the side chains are still shown as numbered alkyl prefixes but in alphabetical order*

## Naming alkenes

- **Alkenes** have the general molecular formula  $C_nH_{2n}$
- They are said to be **unsaturated**
- Alkenes are named using the nomenclature rule **alk + ene**



Your notes

- In molecules with a straight chain of 4 or more carbon atoms, the position of the C=C double bond must be specified
  - The carbon atoms on the straight chain must be numbered, starting with the end closest to the double bond
  - The lowest-numbered carbon atom participating in the double bond is indicated just before the -ene:

### IUPAC system of naming alkenes table

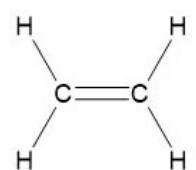
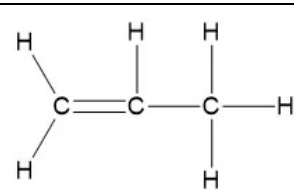
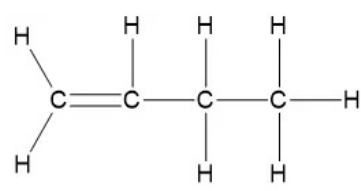
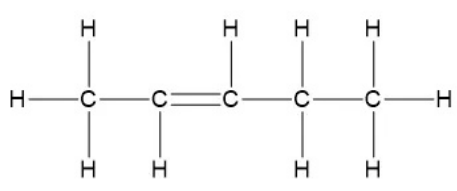
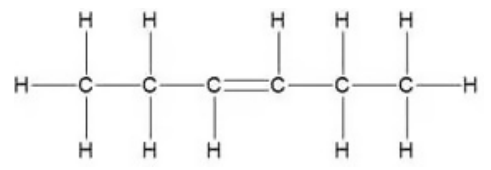
Number of carbon atoms	Displayed formula of straight-chain alkene	Molecular formula of alkene	IUPAC name of alkene
1	-	-	-
2		C <sub>2</sub> H <sub>4</sub>	ethene
3		C <sub>3</sub> H <sub>6</sub>	propene
4		C <sub>4</sub> H <sub>8</sub>	but-1-ene
5		C <sub>5</sub> H <sub>10</sub>	pent-2-ene
6		C <sub>6</sub> H <sub>12</sub>	hex-3-ene

- There is a distinction to be made between the name of the **functional group** and the name of the **family**

- The name of the family is **alkene**
- The name of the functional group is **alkenyl**

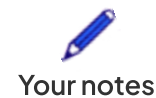

## Naming alkynes

- **Alkynes** have the general molecular formula  $C_nH_{2n-2}$
- The triple bond makes them **unsaturated** molecules
- Alkynes are named using the nomenclature rule **alk + yne**
- In molecules with a straight chain of 4 or more carbon atoms, the position of the C≡C triple bond must be specified
  - The carbon atoms on the straight chain must be numbered, starting with the end closest to the triple bond
  - The lowest-numbered carbon atom participating in the triple bond is indicated just before the -yne:

### IUPAC system of naming alkynes table

Number of carbon atoms	Displayed formula of straight-chain alkyne	Molecular formula of alkyne	IUPAC name of alkyne
1	-	-	-
2	$H-C \equiv C-H$	$C_2H_2$	ethyne
3	$  \begin{array}{c}  H \\    \\  H-C \equiv C-C-H \\    \\  H  \end{array}  $	$C_3H_4$	propyne
4	$  \begin{array}{c}  H \quad H \\    \quad   \\  H-C \equiv C-C-C-H \\    \quad   \\  H \quad H  \end{array}  $	$C_4H_6$	but-1-yne
5	$  \begin{array}{c}  H \quad \quad H \quad H \\    \quad \quad   \quad   \\  H-C-C \equiv C-C-C-H \\    \quad \quad   \quad   \\  H \quad \quad H \quad H  \end{array}  $	$C_5H_8$	pent-2-yne

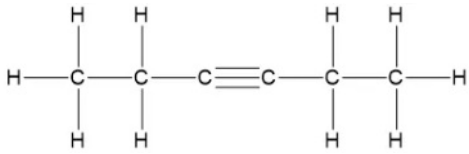

6		$C_6H_{10}$	hex-3-yne
---	---	-------------	-----------

- There is a distinction to be made between the name of the **functional group** and the name of the **family**
  - The name of the family is **alkyne**
  - The name of the functional group is **alkynyl**

### Naming arenes

- Arenes are **aromatic** compounds, i.e. compounds with one or more rings with **pi electrons** that are **delocalised** throughout the ring(s)
- **Benzene,  $C_6H_6$** , is the only **aromatic hydrocarbon** that is covered in IB Chemistry and is covered in our [Benzene revision note](#)
- Naming aromatic compounds depends on whether the benzene ring is considered the main structure or a functional group
  - Benzene as the main structure:
    - Alkyl groups attached to benzene rings are named using the nomenclature rule **alkyl group + benzene**
    - If there is only one alkyl group attached, then no numbering system is applied to the benzene ring
    - If more than one alkyl group is attached, then a relative numbering system is applied
      - This is where the longest alkyl chain is considered as being attached to carbon-1 of the ring
      - The other alkyl groups are then numbered accordingly
      - The alkyl groups are still named in alphabetical order

#### Examples of alkyl substituted aromatic compounds

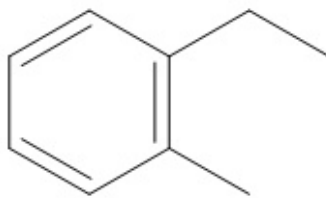
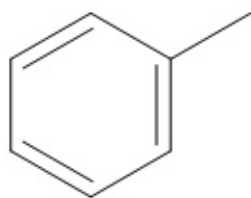

**Methylbenzene is often called by the common name toluene. 1-ethyl-2-methylbenzene has the longest (ethyl) side chain set as carbon-1, so the methyl side chain is attached to carbon-2**

- Benzene as a functional group:
  - The functional group in **benzene** is known as a **phenyl group** when attached to other molecules

### Benzene as the functional group

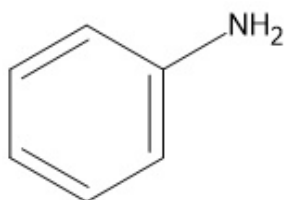

The benzene ring is considered a functional group in amine structures, which means that this aromatic compound is called phenylamine

## Halogenoalkanes

- **Halogenoalkanes** have the general molecular formula,  $C_nH_{2n+1}X$ , where X represents a halogen
- **Halogenoalkanes** are named using the prefix **chloro-**, **bromo-** or **iodo-**, with the ending **-ane**
- In molecules with a straight chain of three or more carbon atoms, the position of the halogen atom must also be specified
  - The carbon atoms on the straight chain must be numbered, starting with the end closest to the halogen atom
  - The number of the carbon atom attached to the halogen is indicated before the prefix:

### Halogenoalkanes Examples Table

Displayed formula of halogenoalkane	Molecular formula of halogenoalkane	IUPAC name of halogenoalkane
<pre>       H   H             H — C — C — H                   H   Cl                     </pre>	$C_2H_5Cl$	chloroethane
<pre>       H   H   H                 H — C — C — C — H                       H   Br  H                     </pre>	$C_3H_7Br$	2-bromopropane
<pre>       H   H   H   H   H                         H — C — C — C — C — C — I                               H   H   H   H   H                     </pre>	$C_5H_{11}I$	1-iodopentane



$  \begin{array}{ccccccccc}  & \text{H} & \text{H} & \text{H} & \text{H} & \text{H} & & & \\  &   &   &   &   &   & & & \\  \text{H} & -\text{C} & -\text{C} & -\text{C} & -\text{C} & -\text{C} & -\text{H} & & \\  &   &   &   &   &   & & & \\  & \text{H} & \text{H} & \text{Cl} & \text{H} & \text{H} & & &   \end{array}  $	$\text{C}_5\text{H}_{11}\text{Cl}$	3-chloropentane
---	------------------------------------	-----------------

- For halogenoalkanes with multiple halogen functional groups, the position and type of functional group must be given
  - For example, an ethane chain with 2 chlorine functional groups on carbon-1 and one chlorine functional group on carbon 2 will be named 1,1,2-trichloroethane

## Alcohols

- Alcohols** are a family of molecules that contain the **hydroxyl functional group**,  $-\text{OH}$
- Their general formula is  $\text{C}_n\text{H}_{2n+1}\text{OH}$
- The nomenclature of alcohols follows the pattern **alkan + ol**
  - If there are two  $-\text{OH}$  groups present the molecule is called a **diol**

### Primary alcohols examples table

Displayed formula of primary alcohol	Structural formula of primary alcohol	IUPAC name of primary alcohol
$  \begin{array}{c}  \text{H} \\    \\  \text{H}-\text{C}-\text{O}-\text{H} \\    \\  \text{H}  \end{array}  $	$\text{CH}_3\text{OH}$	methanol
$  \begin{array}{c}  \text{H} \quad \text{H} \\    \quad   \\  \text{H}-\text{C}-\text{C}-\text{O}-\text{H} \\    \quad   \\  \text{H} \quad \text{H}  \end{array}  $	$\text{CH}_3\text{CH}_2\text{OH}$	ethanol
$  \begin{array}{c}  \text{H} \quad \text{H} \quad \text{H} \\    \quad   \quad   \\  \text{H}-\text{C}-\text{C}-\text{C}-\text{O}-\text{H} \\    \quad   \quad   \\  \text{H} \quad \text{H} \quad \text{H}  \end{array}  $	$\text{CH}_3\text{CH}_2\text{CH}_2\text{OH}$	propan-1-ol

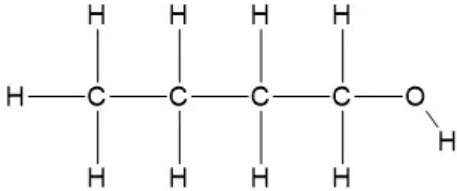

	$\text{CH}_3\text{CH}_2\text{CH}_2\text{CH}_2\text{OH}$	butan-1-ol
---	---	------------

- Further information about the classification of alcohols as **primary**, **secondary** or **tertiary** can be found in our [Structural Isomers revision note](#)

## Carbonyls

- Carbonyl** is the collective name for compounds containing the functional group **C=O**
- The general formula of a carbonyl is **C<sub>n</sub>H<sub>2n</sub>O**
- The two sub-families of **carbonyls** are **aldehydes** and **ketones** (known in some countries as alkanals and alkanones)

## Aldehydes

- If the carbonyl group is on the end of a chain then it is an **aldehyde** and has the functional group formula, **RCHO**
  - The H is written before the O so as not to confuse it with an alcohol
- The nomenclature of **carbonyls** follows the pattern **alkan + al**
- There is no need to use numbers in the name as aldehyde will always be on the number 1 carbon atom

## Ketones

- Ketones** have a minimum of three carbons and have the general functional group formula, **RCOR**
- The nomenclature of **ketones** follows the pattern **alkan + one**
- After butanone, the **carbonyl** group can have **positional isomers**, so numbering must be used
  - For example pentan-2-one and pentan-3-one

### Carbonyls examples table

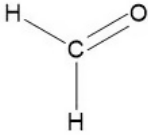
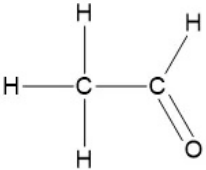
Displayed formula of carbonyl	Structural formula of carbonyl	IUPAC name of carbonyl
	$\text{CH}_2\text{O}$	methanal (also known as formaldehyde)
	$\text{CH}_3\text{CHO}$	ethanal

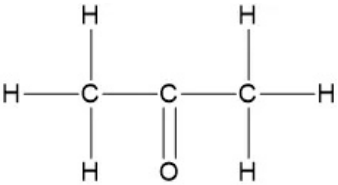
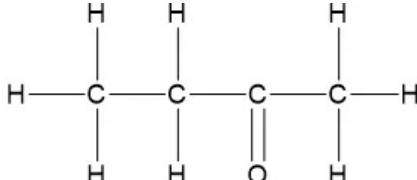

	$\text{CH}_3\text{COCH}_3$	propanone (also known as acetone)
	$\text{CH}_3\text{CH}_2\text{COCH}_3$	butanone

- As they have a very similar functional group arrangement, **aldehydes** and **ketones** show similar chemical reactions
- Differences in their chemistry are due to the reactions that involve the H on the **aldehyde** or the nature of the R group
- The difference in **electronegativity** between oxygen and carbon means the C=O is polar, leading to dipole-dipole attractions between the molecules which results in:
  - Higher than expected boiling points for small molecules
  - Solubility in water for the lower members of the families
- Aldehydes** and **ketones** with the same number of carbons are **functional group isomers**

## Carboxylic acids

- Carboxylic acid** is the name given to compounds containing the functional group **carboxyl**, **-COOH**
- The general formula of a carboxylic acid is  $\text{C}_n\text{H}_{2n+1}\text{COOH}$  which can be shortened to just **RCOOH**
  - (In some countries the family is called alcanoic acid)
- The nomenclature of **carboxylic acids** follows the pattern **alkan + oic acid**
- There is no need to use numbers in the name as the carboxyl group will always be on the number 1 carbon atom

### Carboxylic Acids Examples Table

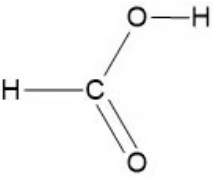
Displayed formula of carboxylic acid	Structural formula of carboxylic acid	IUPAC name of carboxylic acid
	$\text{HCO}_2\text{H}$	methanoic acid (also known as formic acid)

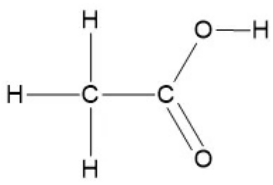
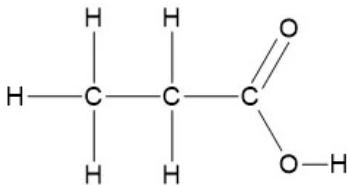

Your notes

	$\text{CH}_3\text{CO}_2\text{H}$	ethanoic acid (also known as acetic acid)
	$\text{CH}_3\text{CH}_2\text{CO}_2\text{H}$	propanoic acid



Your notes

## Structural Isomers

### Structural Isomers

#### What are isomers?

- Isomers are compounds that have the same molecular formula but a different arrangement of atoms
- One group of isomers is the structural isomers
  - These are compounds that have the same molecular formula but different structural formulae

#### Isomers of $C_3H_6$

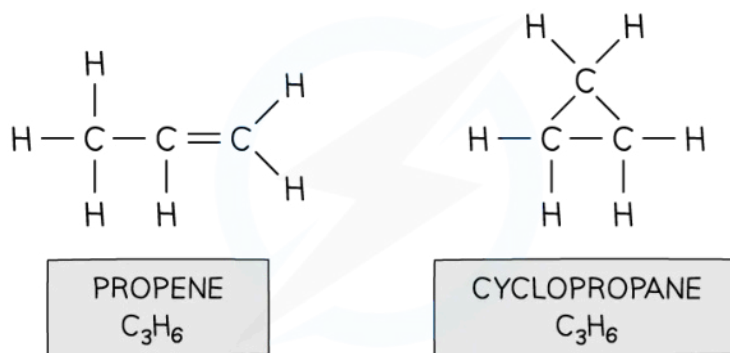

Copyright © Save My Exams. All Rights Reserved

*Propene and cyclopropane are both made of 3 carbon and 6 hydrogen atoms but the structure of the two molecules differs*

- There are three different types of structural isomerism:
  - Functional group** isomerism
  - Positional** isomerism
  - Branched chain** isomerism

#### Functional group isomerism

- When different functional groups result in the same molecular formula, **functional group isomers** arise
- These isomers have very **different chemical properties** as they have different functional groups

#### Functional group isomers of $C_4H_{10}O$

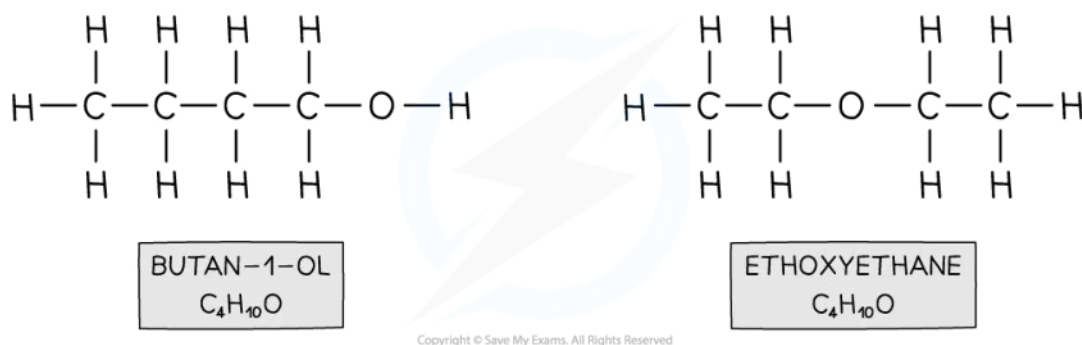

Copyright © Save My Exams. All Rights Reserved

**Both compounds have the same molecular formula however butan-1-ol contains an alcohol functional group and ethoxyethane an ether functional group**

- It can help to be aware of which **homologous series** can be functional group isomers of each other:
  - Alkenes and cycloalkanes
  - Alcohols and ethers
  - Aldehydes and ketones

## Positional isomerism

- Positional isomers arise from differences in the position of a functional group in each isomer
  - This literally means that the functional group is located on different carbon atoms

### Position isomers of butanol, $\text{C}_4\text{H}_9\text{OH}$ , diagram

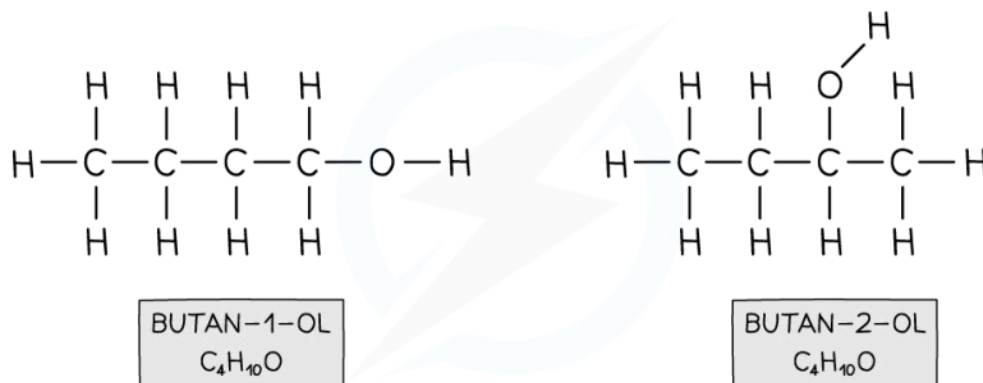

Copyright © Save My Exams. All Rights Reserved

**Both compounds are made up of 4 carbon, 10 hydrogen and one oxygen atom. However, the alcohol / OH group is located on different carbon atoms**

- In the example above, the functional group is the alcohol / OH group
  - The OH group can be attached to carbon-1, which gives rise to butan-1-ol
  - The OH group can be attached to carbon-2, which gives rise to butan-2-ol
  - **Careful:** In the butan-1-ol diagram, it appears that the OH group is attached to carbon-4
    - If you imagine looking at the molecule from the other side, you would see that the OH group is attached to carbon-1



Your notes

- The same is true of butan-2-ol, where the OH group appear to be attached to carbon-3
- Some organic compounds that can be described as having **primary**, **secondary** or **tertiary** structures will exhibit isomerism
  - The terms **primary**, **secondary** and **tertiary** relate to the number of carbon atoms that the functional group carbon is attached to

### Demonstrating primary, secondary and tertiary structures in alcohols

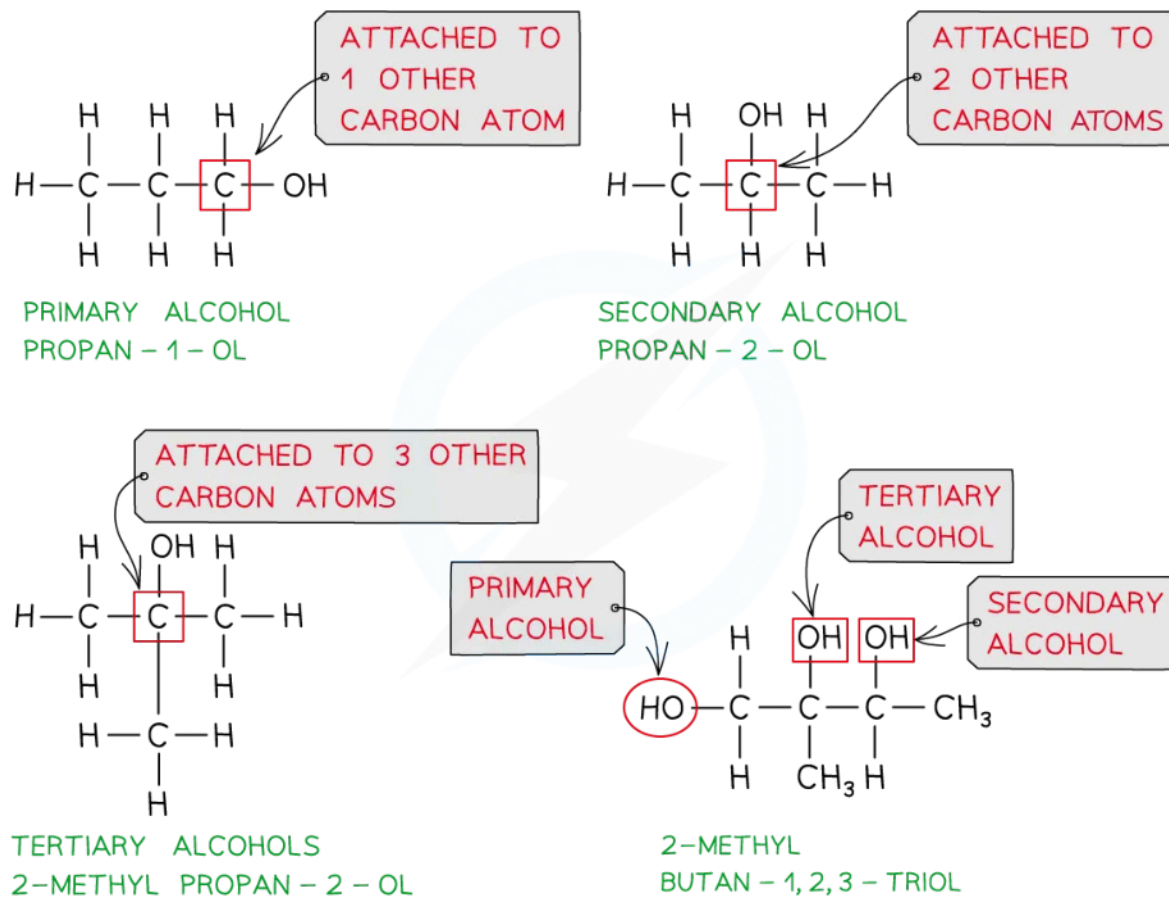

Copyright © Save My Exams. All Rights Reserved

### Classifying primary, secondary and tertiary alcohols and alcohols with more than one alcohol group

- Alcohols**, e.g. propanol
  - The primary alcohol propan-1-ol and the secondary alcohol propan-2-ol are position isomers of each other
  - Careful:** The tertiary alcohol 2-methylpropan-2-ol is another isomer but it is branched chain **not** position isomerism
- Halogenoalkanes**, e.g.  $C_4H_{11}Br$ 
  - The primary halogenoalkane 1-bromobutane and the secondary halogenoalkane 2-bromobutane are position isomers of each other

- **Careful:** The tertiary halogenoalkane 2-bromo-2-methylpropane is another isomer but, again, it is branched chain **not** position isomerism



Your notes

## Branched chain isomerism

- Branch-Chain isomerism is when compounds have the same molecular formula, but their longest hydrocarbon chain is not the same
- This is caused by branching, i.e. where the longest hydrocarbon is broken into smaller pieces and some of these smaller pieces are added as side-chains / branches

### Isomers of $C_5H_{12}$

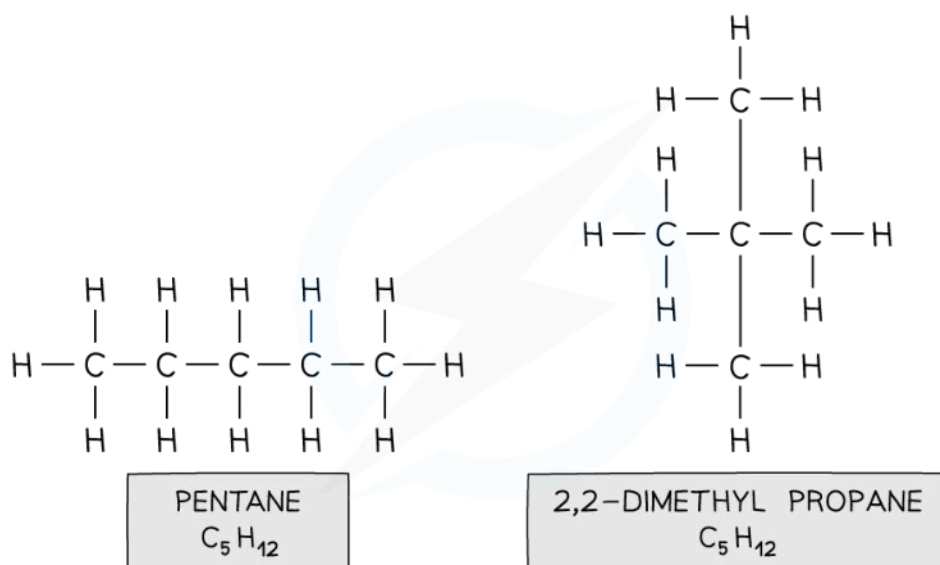

Copyright © Save My Exams. All Rights Reserved

*Both compounds contain 5 carbon and 12 hydrogen atoms. However, the longest carbon chain in pentane is 5 and in 2,2-dimethylpropane it is 3 (with two methyl branches)*

## Isomerism in amines

- **Amines** follow a slightly different classification system to alcohols and halogenoalkanes, although the terms **primary**, **secondary** and **tertiary** are still used
- The classification is based on the number of alkyl groups attached to the nitrogen in the **amine**
  - **Primary amines** are those in which the nitrogen is attached to **one** other carbon atom (or alkyl group)
  - In **secondary amines**, the nitrogen atom is attached to **two** other carbon atoms (or alkyl groups)
  - In **tertiary amines**, the nitrogen is attached to **three** other carbon atoms (or alkyl groups)

### Examples of primary, secondary and tertiary amines





Your notes

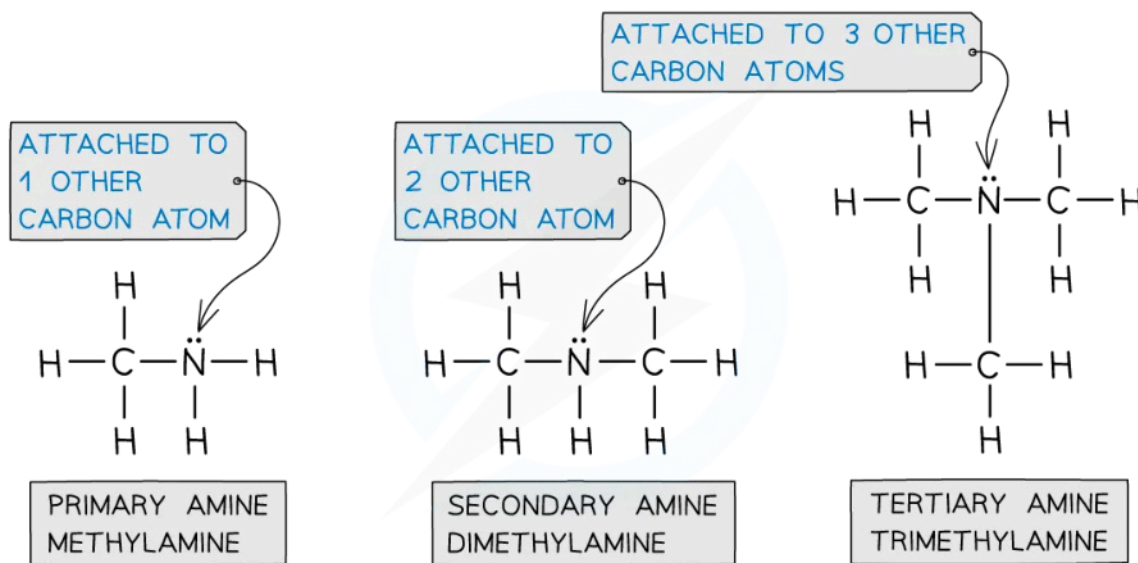

**The number of carbons attached to the nitrogen atom indicate if an amine is primary (1 carbon), secondary (2 carbons) or tertiary (3 carbons)**

- This means that amines do show isomerism
  - It is ambiguous whether isomerism in amines is position or branched chain
  
- You should be able to deduce all possible isomers for organic compounds knowing their molecular formula



Your notes

### Worked example

How many structural isomers are there of  $C_3H_6Br_2$ ?

**Answer:**

**Step 1:** Draw a displayed formula of the compound

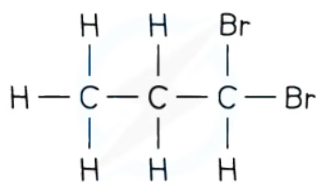

Copyright © Save My Exams. All Rights Reserved

**Step 2:** Determine whether there is functional group, branched chain or positional isomerism

- Functional group?
  - No, Br is the only functional group present
- Branched chain?
  - No, the longest carbon chain is 3 carbons which cannot branch:

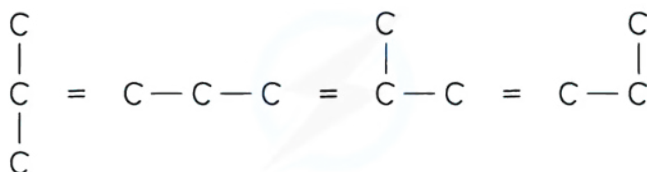

Copyright © Save My Exams. All Rights Reserved

- Positional?
  - Yes, there are two bromine atoms that can be bonded to different carbon atoms

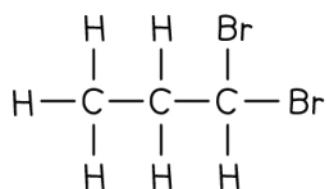
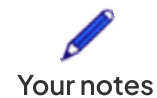

AND

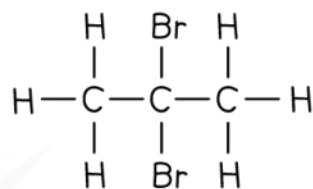

1,1-DIBROMOPROPANE

2,2-DIBROMOPROPANE

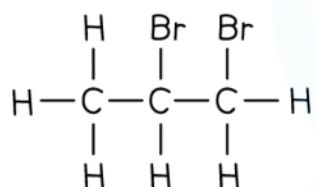

AND

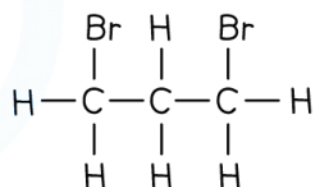

1,2-DIBROMOPROPANE

1,3-DIBROMOPROPANE

$\text{C}_3\text{H}_6\text{Br}_2$  THEREFORE HAS 4 STRUCTURAL ISOMERS

Copyright © Save My Exams. All Rights Reserved



Your notes

### Worked example

How many isomers are there of the compound with molecular formula  $C_4H_{10}$ ?

**Answer:**

**Step 1:** Draw one possible structural formula of the compound

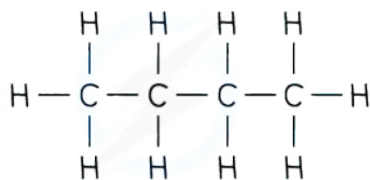

Copyright © Save My Exams. All Rights Reserved

**Step 2:** Determine whether it is a functional group, branched chain or positional isomerism

- Functional group?
  - No, there are no functional groups
- Positional?
  - No, as there are no functional groups which can be positioned on different carbon atoms
- Branched chain
  - Yes, a carbon chain containing 4 carbons is the smallest chain that can exhibit branched chain isomerism



Your notes

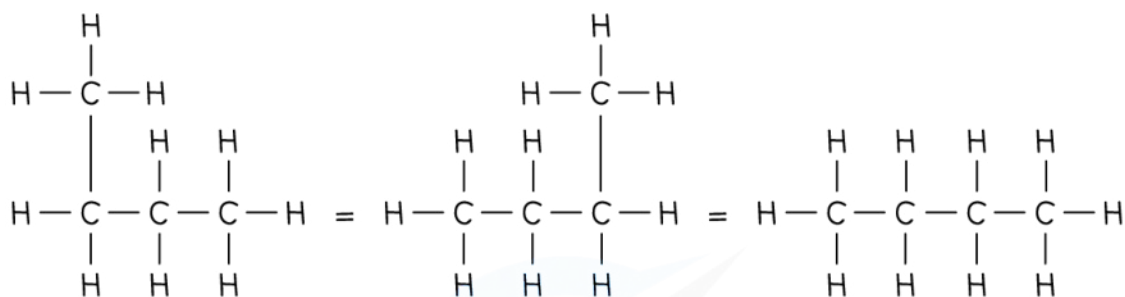

BUTANE

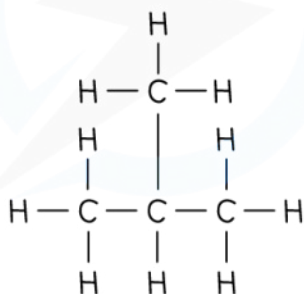

2-METHYLPROPANE

$\text{C}_4\text{H}_{10}$  THEREFORE HAS 2 STRUCTURAL ISOMERS

Copyright © Save My Exams. All Rights Reserved

### Examiner Tip

Don't be fooled by molecules by bending and turning through 90 degrees - that does not make them isomers. The best test is to try and name them - isomers will have a different name.



Your notes

## Cis-Trans Isomers (HL)

### Cis-Trans Isomers

- Isomers can be grouped into various categories, as shown:

Flow chart of the various isomers

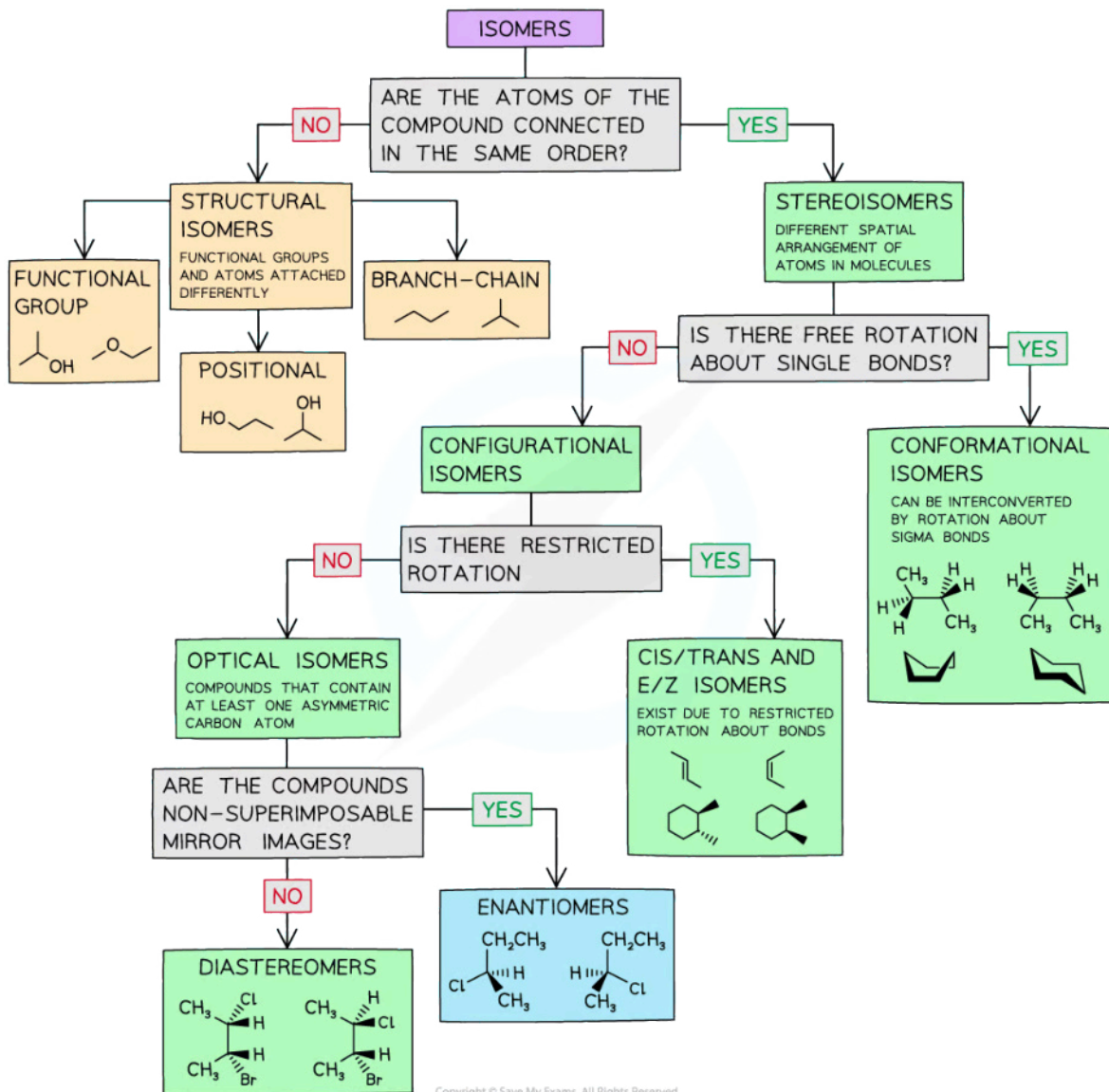

Copyright © Save My Exams. All Rights Reserved

The flow chart guides you through all the relevant points of the different isomers

- We have already encountered three types of structural isomers, in our revision note on Structural Isomers:

- Functional group isomers, e.g. propanal and propanone
- Position isomers, e.g. propan-1-ol and propan-2-ol
- Branched chain isomers, e.g. butane and methylpropane
- If the atoms within an isomer are arranged in the same order then we are dealing with stereoisomers
- Stereoisomers can be **conformational** or **configurational**

## Conformational Isomers

- Conformational isomers, or conformers, occur due to free rotation about a single  $\sigma$ -bond and can be described as:
  - Staggered
  - Eclipsed
- One of the simplest examples of conformational isomerism is ethane,  $\text{CH}_3\text{CH}_3$

### Structural formula of ethane

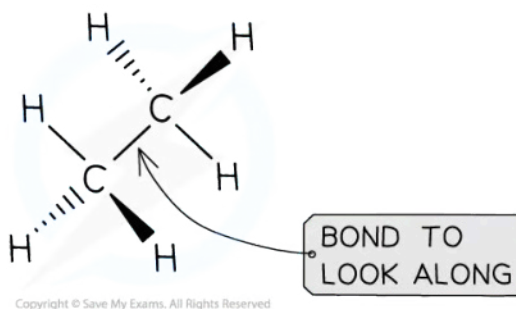

*The central carbon-carbon single bond is identified as the bond for conformational isomerism*

- By looking along the C-C bond highlighted in the diagram we can draw the two Newman projections, staggered and eclipsed

### The staggered and eclipsed conformers of ethane

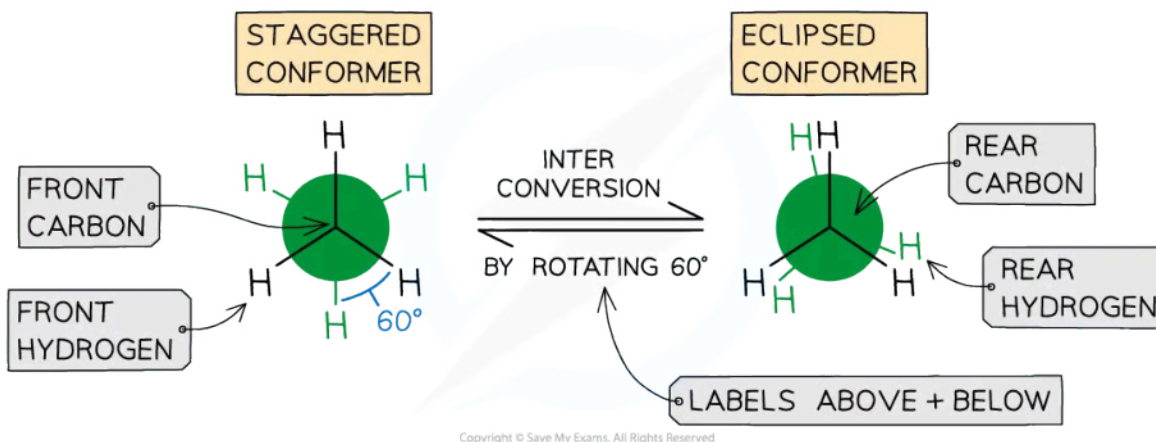



Your notes

## The different geometries possible due to the free rotation about the carbon-carbon bond causes the staggered and eclipsed conformers

- The staggered conformer has angles between hydrogen atoms on adjacent carbons of  $60^\circ$ , as shown
  - It is also more stable / lower energy than the eclipsed conformer because the C-H bonds are as far apart as possible to minimise the repulsion between the electrons in the C-H bonds
- The eclipsed conformer has angles between hydrogen atoms on adjacent carbons of  $0^\circ$ , this is not shown in the diagrams so that the conformation can be seen
  - The eclipsed conformer is less stable / higher energy due to the repulsion between the electrons in the C-H bonds that are closer together
- The free rotation that causes these conformers means that it is easy to interconvert from one conformer to the other and back
  - This is also the reason that it is almost impossible to isolate a single conformer

## Conformational Isomerism in Cyclic Structures

- Conformational isomerism can also be seen in cyclic structures
- A common example of this is cyclohexane,  $C_6H_{12}$ 
  - Cyclohexane isomers exist in boat and chair forms:

### Skeletal structures showing the boat and chair forms of cyclohexane



**Due to free rotation about the single bonds, cyclohexane can adopt two configurations commonly called boat and chair**

- The boat form is less stable / higher energy as there are four eclipsed bonds causing strain on the overall structure
  - There is also repulsion of the hydrogen atoms on the end of the boat structure
- It is possible to "flip" between the boat and chair forms which explains the difficulty in isolating just one of the forms
  - During the interconversions, it is also possible to get other structures commonly called the half chair and the twisted boat

## Configurational Isomers

- **Configurational isomerism** can be seen in unsaturated compounds, cyclic structures or compounds that contain at least one asymmetric carbon (sometimes called a chiral centre)
  - These structures have the same molecular formula and order of atoms (the atoms are connected similarly to each other) but different shapes



- Interconversion of configurational isomers can only occur by breaking bonds or rearranging stereocentres
- Configurational isomers can be divided into:
  - Cis / trans isomers and E / Z isomers
  - Optical isomers - see our revision note on [Enantiomers](#)

### Examiner Tip

- You may still see the term geometric isomers being used when talking about some configurational isomers
- This was recommended by IUPAC but it is now obsolete and being replaced with cis-trans isomers and E/Z isomers
  - E / Z isomers are not part of the current IB specification

## Cis / trans isomers

- In saturated compounds, the atoms / functional groups attached to the single,  $\sigma$ -bonded carbons are not fixed in their position due to the free rotation about the C-C  $\sigma$ -bond
  - This causes conformational isomers
- In unsaturated compounds, the groups attached to the C=C carbons remain fixed in their position
  - This is because free rotation of the bonds about the C=C bond is not possible due to the presence of a  $\pi$  bond
- Cis / trans nomenclature can be used to distinguish between the isomers
  - Cis isomers have two functional groups on the same side of the double bond / carbon ring, i.e. both above the C=C bond or both below the C=C bond
  - Trans isomers have two functional groups on opposite sides of the double bond / carbon ring, i.e. one above and one below the C=C bond

### Comparing 1,2-ethanediol with cis and trans isomers of 1,2-ethenediol



Your notes

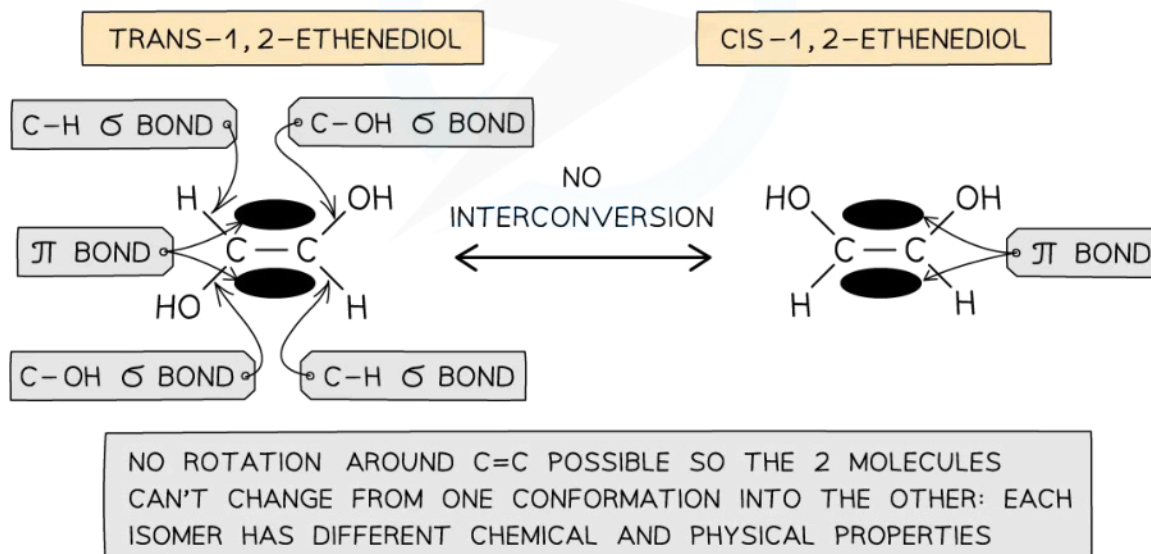
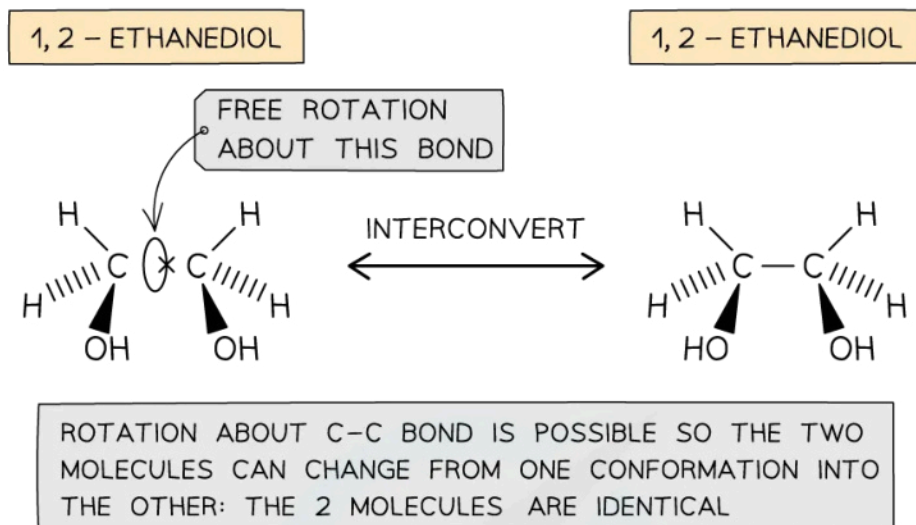

Copyright © Save My Exams. All Rights Reserved

**The presence of a  $\pi$  bond in unsaturated compounds restricts rotation about the C=C bond forcing the groups to remain fixed in their position and giving rise to the formation of certain configurational isomers**

## Naming cis / trans isomers

- For cis / trans isomers to exist, we need two different atoms or groups of atoms on either side (above and / or below) of the C=C bond
  - This means that 2-methylpropene cannot have cis / trans isomers as the methyl groups are both on the same side of the C=C bond:

### Full structural formula of 2-methylpropene

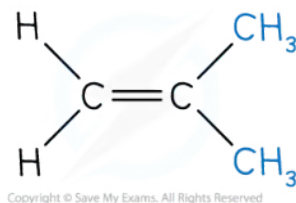

*2-methylpropene molecules do not have cis / trans isomers*

- However, moving one of the methyl groups to the other side of the C=C bond causes cis / trans isomerism:

### Full structural formula of the cis and trans isomers of but-2-ene

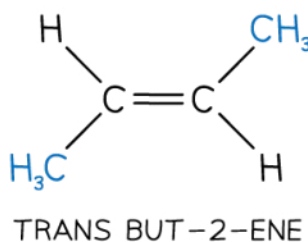
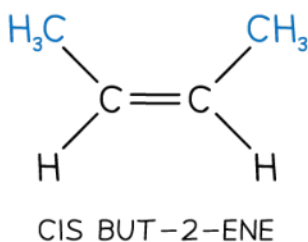

Copyright © Save My Exams. All Rights Reserved

*But-2-ene does have cis / trans isomers*

- The atoms or groups of atoms on either side of the C=C bond do not have to be the same for cis / trans isomers:

### Full structural formula of the cis and trans isomers of 1-chloroprop-1-ene

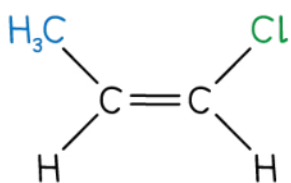

CIS 1-CHLOROPROP-1-ENE

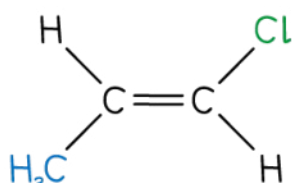

TRANS 1-CHLOROPROP-1-ENE

Copyright © Save My Exams. All Rights Reserved

*1-chloroprop-1-ene also shows cis / trans isomerism*

## Limitations of cis / trans nomenclature

- The cis / trans naming system starts to fail once we have more than one atom or group of atoms on either side of the C=C bond
- The cis / trans naming system can still be used with three atoms / groups of atoms but only if:
  - Two of the three atoms or groups of atoms are the same
  - These two atoms or groups of atoms are on opposite sides of the double bond



### Full structural formula of the cis and trans isomers of 1,2-dichloropropene

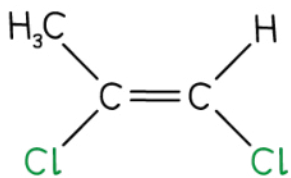

CIS 1,2-DICHLOROPROPENE HAS BOTH Cl ATOMS ON THE SAME SIDE

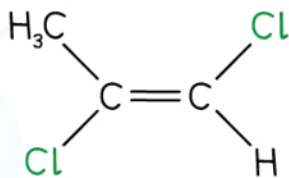

TRANS 1,2-DICHLOROPROPENE HAS BOTH Cl ATOMS ON THE OPPOSITE SIDES

Copyright © Save My Exams. All Rights Reserved

*1,2-dichloropropene can be named using cis / trans nomenclature*

- The cis / trans naming system cannot be used with three atoms / groups of atoms when they are all different

### Full structural formula of 1-bromo-2-chloropropene

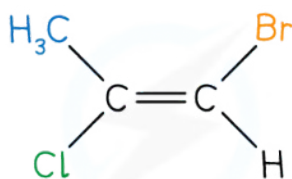

1-BROMO-2CHLOROPROPENE

Copyright © Save My Exams. All Rights Reserved

*1-bromo-2-chloropropene cannot be named using cis / trans nomenclature*

### Cyclic cis / trans isomers

- Cis / trans isomerism can also occur in cyclic structures
- Even though cyclic alkanes contain single carbon-carbon bonds, the rigid structure of the ring system does not allow for free rotation
  - Therefore, cis isomers can occur when the atoms (or groups of atoms) are on the same side of the ring, i.e. both above or both below
  - While trans isomers can occur when the atoms (or groups of atoms) are on the opposite side of the ring, i.e. one above and one below

#### Cis / trans isomerism in cyclic compounds

CIS-1, 4-CYCLOHEXANEDIOL

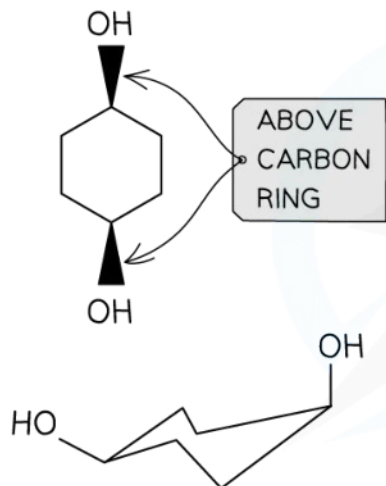

CIS-1, 4-CYCLOHEXANEDIOL

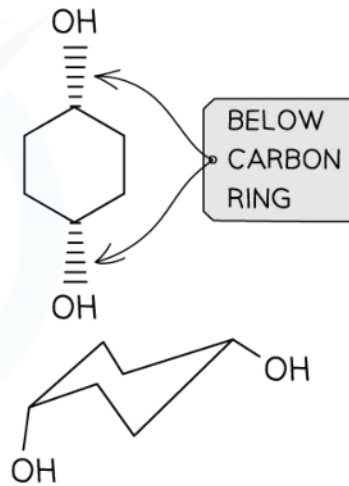

Copyright © Save My Exams. All Rights Reserved

***Cis isomers have both groups above or both groups below, while trans isomers have one group above and one group below***

## Enantiomers (HL)



Your notes

### Enantiomers

#### What are optical isomers?

- **Optical isomers** are chemicals that contain a **chiral carbon** or **chiral centre**
  - A chiral carbon atom has four different atoms or groups of atoms attached to it
  - Chira comes from a Greek word meaning hand, so we talk about these molecules having a handedness
- The carbon atom is described as being **asymmetric**, i.e. there is no plane of symmetry in the molecule
- Compounds with one chiral centre (**chiral molecules**) exist as a pair of optical isomers, also known as **enantiomers**
  - Enantiomers are drawn using stereochemical formulae - see our revision note on [Representing Formulas of Organic Compounds](#)
- Just like the left hand cannot be superimposed on the right hand, enantiomers are **non-superimposable**
  - Enantiomers are mirror images of each other

#### How optical isomers form

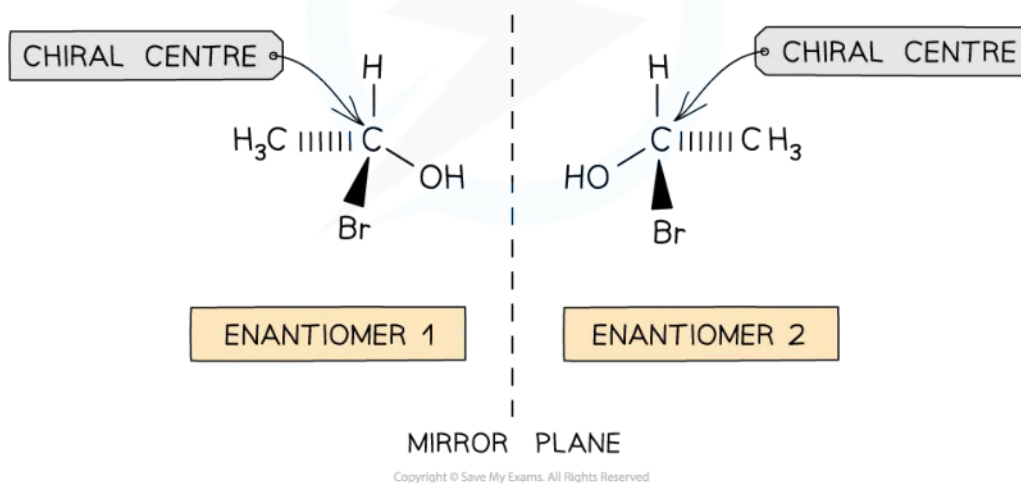
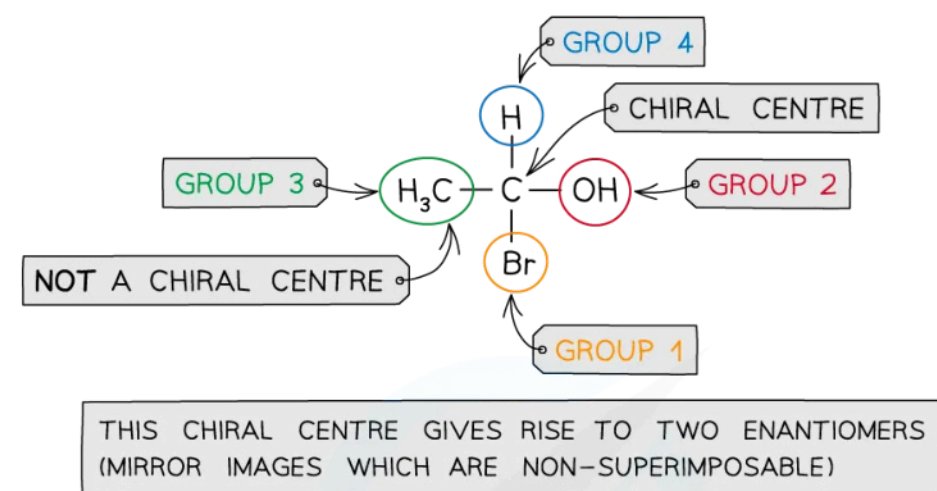

**A molecule has a chiral centre when the carbon atom is bonded to four different atoms or group of atoms; this gives rise to enantiomers**

## How to draw optical isomers

- Optical isomers are drawn using **stereochemical formulae** to show the **tetrahedral arrangement** around the chiral carbon
  1. Start with a central chiral carbon
  2. Add 2 lines for the bonds that are in the plane
  3. Add one solid wedge for the bond that is coming forward, out of the plane
  4. Add one dashed wedge for the bond that is going backwards, out of the plane
  5. Then draw a mirror image of this

### Basic structure of all optical isomers

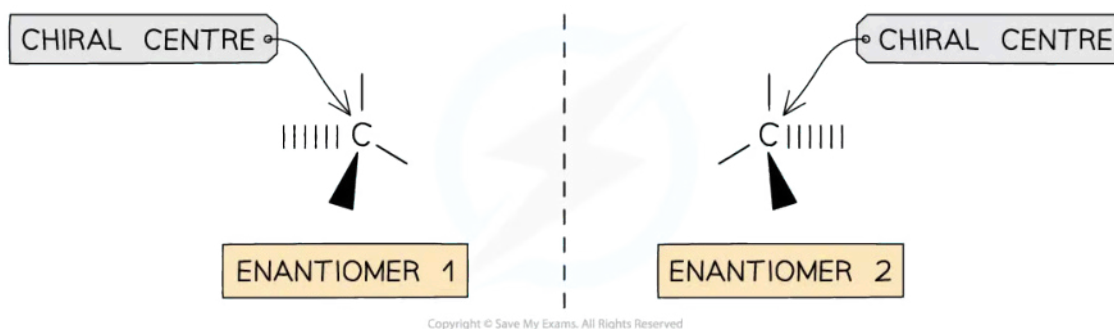

**All optical isomers exist in pairs and are represented by stereochemical formulae**

- The four different atoms or functional groups are added to each carbon on enantiomer 1
  - Enantiomer 2 then has the same atoms or functional groups added but in a way that forms the mirror image of enantiomer 1

### Can optical isomers contain more than one chiral carbon?

- Optical isomers can contain one or more chiral carbons
  - Isomers with **one chiral centre** will form **enantiomers** or mirror images
- **Diastereomers** are compounds that contain **more than one chiral centre**
  - Diastereomers are **not mirror images** of each other because each chiral carbon has two isomers
  - This means that they have different physical and chemical properties

#### Diastereomers of 2-bromo-3-chlorobutane

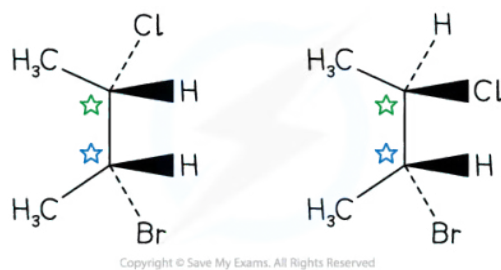

**2-bromo-3-chlorobutane exists as a diastereomer due to 2 chiral centres**

## Properties of optical isomers

### Chemical properties

- Knowledge of the different chemical properties of enantiomers is limited to different behaviours in chiral environments.
- For example, optical isomers interact with biological sensors in different ways:
  - One enantiomer of carvone smells of spearmint
  - The other enantiomer of carvone smells of caraway

#### Optical isomers of carvone



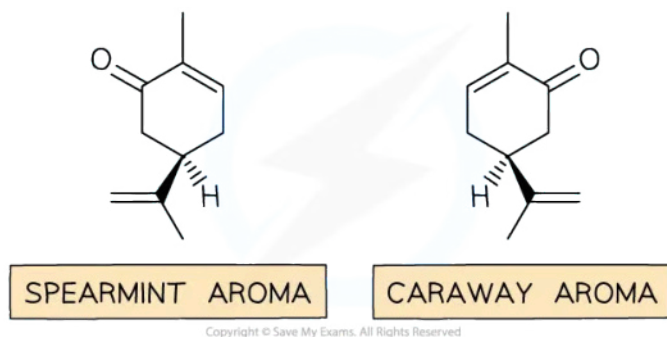

*The different optical isomers of carvone have distinctive smells*

### Physical properties

- Optical isomers have identical physical properties, with one exception:
- Isomers differ in their ability to rotate the plane of polarised light
  - This means that enantiomers are described as optically active
  - Diastereomers are not typically optically active

#### How a polariser works

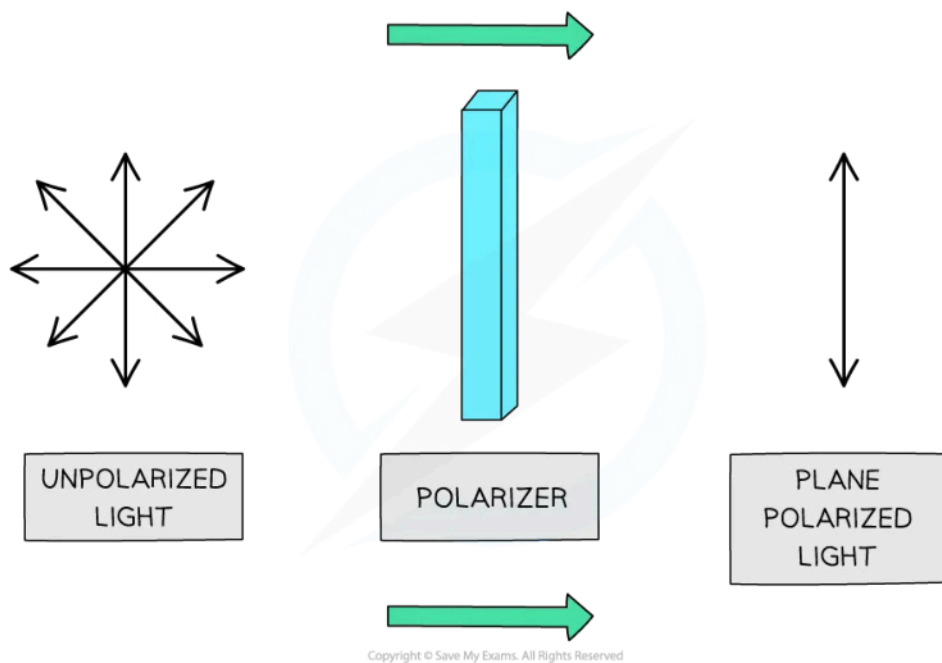

*When unpolarised light is passed through a polariser, the light becomes polarised as the waves will vibrate in one plane only*

- The major difference between the two enantiomers is:



Your notes

- One enantiomer rotates plane polarised light in a **clockwise** direction and the other in an **anticlockwise** direction
- A common way to differentiate the isomers is to use (+) and (-), but there are other systems using d and l, D and L, or R and S
- The rotation of plane polarised light can be used to determine the identity of an optical isomer of a single substance
  - For example, pass plane polarised light through a sample containing one of the two optical isomers of a single substance
  - Depending on which isomer the sample contains, the plane of polarised light will be rotated either clockwise or anti-clockwise by a fixed number of degrees

### How enantiomers interact with plane polarised light

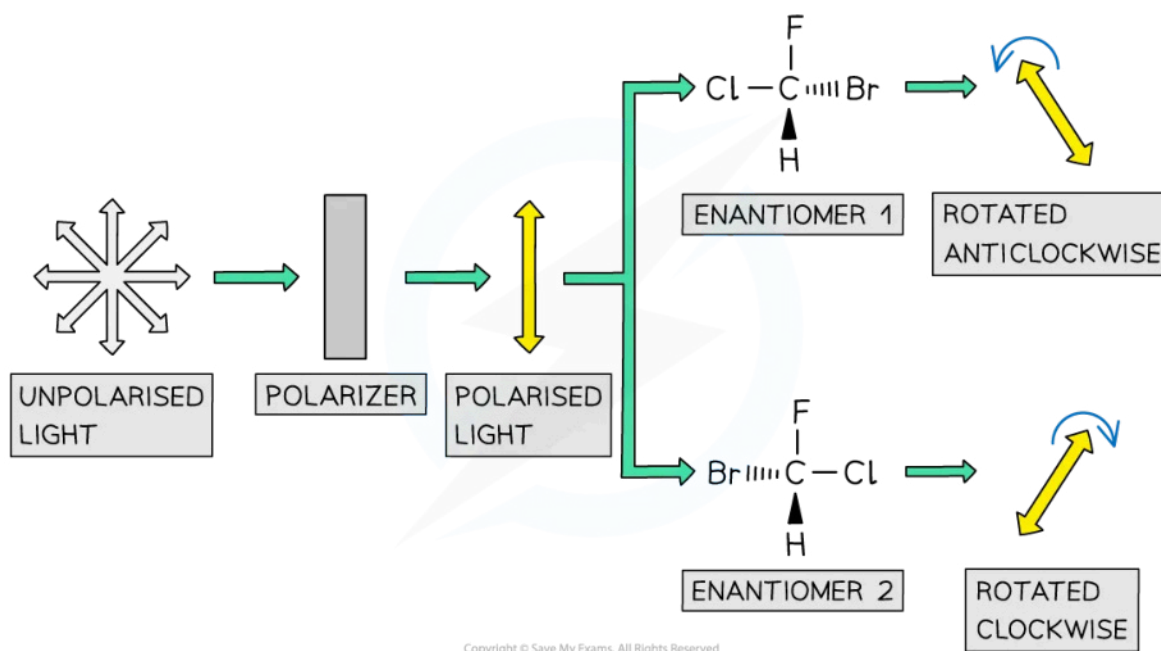

*Each enantiomer rotates the plane of polarised light in a different direction*

### What is a racemic mixture?

- A **racemic mixture** (or **racemate**) is a mixture containing **equal amounts** of each enantiomer
  - One enantiomer rotates light clockwise, the other rotates light anticlockwise
- A racemic mixture is **optically inactive** as the enantiomers will cancel out each other's effect
  - This means that the plane of polarised light will **not change**

### How a racemic mixture interacts with plane polarised light

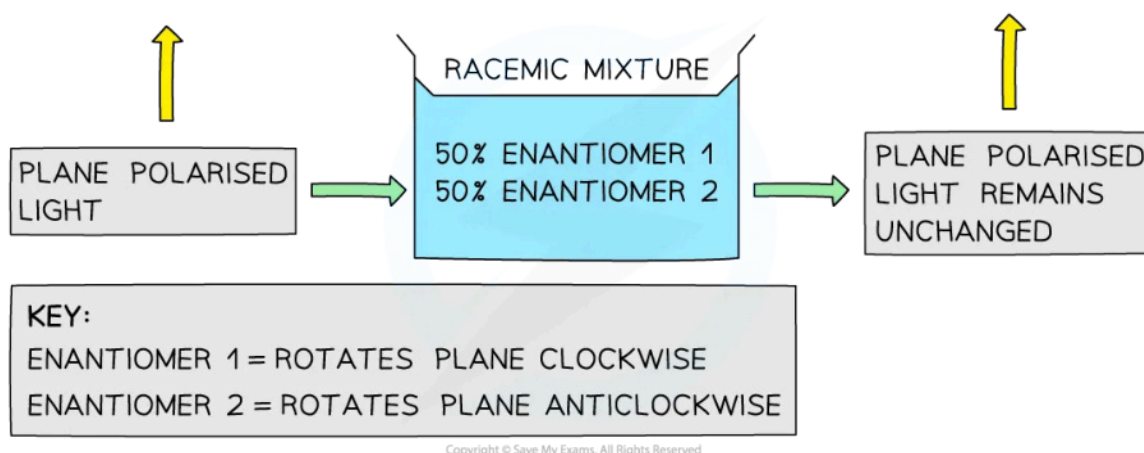

**Racemic mixtures are optically inactive because the enantiomers cancel each other's ability to rotate plane polarised light**

## Racemic mixtures and drugs

- In the pharmaceutical industry, it is much easier to produce synthetic drugs that are racemic mixtures than producing one enantiomer of the drug
- Around 56% of all drugs in use are chiral and of those 88% are sold as racemic mixtures
- Separating the enantiomers gives a compound that is described as **enantiopure**, it contains only one enantiomer
- This separation process is very expensive and time-consuming, so for many drugs it is not worthwhile, even though only half the of the drug is pharmacologically active
- For example, the pain reliever ibuprofen is sold as a racemic mixture

**The structural formula of ibuprofen showing the chiral carbon**

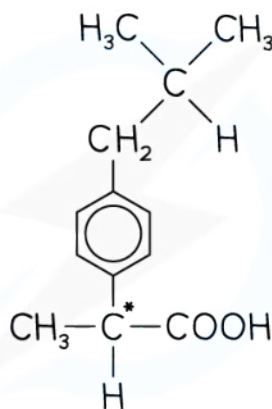

**The chiral carbon of ibuprofen is responsible for the racemic mixture produced in the synthesis of the drug**



Your notes

## Mass Spectrometry (MS) Fragmentation Patterns (HL)

### Mass Spectrometry (MS) Fragmentation Patterns

- When a compound is analysed in a mass spectrometer, vaporised molecules are bombarded with a beam of high-speed electrons
- These knock off an electron from some of the molecules, creating **molecular ions**:

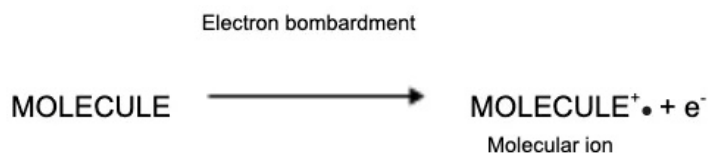

- The relative abundances of the detected ions form a **mass spectrum**: a kind of molecular fingerprint that can be identified by computer using a spectral database
- The peak with the highest ***m/z*** value is the molecular ion (***M*<sup>+</sup>**) peak which gives information about the **molecular mass** of the compound
- This value of *m/z* is equal to the **relative molecular mass** of the compound

### The ***M*+1** peak

- The ***[M+1]*** peak is a smaller peak which is due to the natural abundance of the isotope **carbon-13**
- The height of the ***[M+1]*** peak for a particular ion depends on how many carbon atoms are present in that molecule; the more carbon atoms, the larger the ***[M+1]*** peak is
  - For example, the height of the ***[M+1]*** peak for a hexane (containing six carbon atoms) ion will be greater than the height of the ***[M+1]*** peak of an ethane (containing two carbon atoms) ion



Your notes

### Worked example

Determine whether the following mass spectrum belongs to propanal or butanal

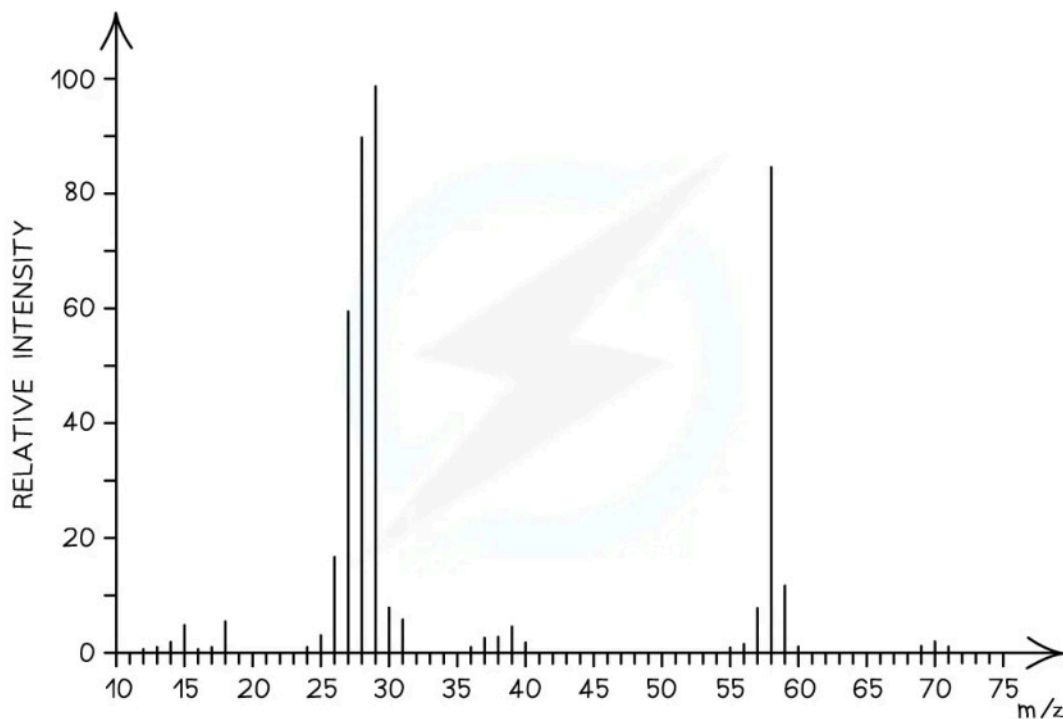

Answer:

- The mass spectrum corresponds to **propanal** as the molecular ion peak is at  $m/z = 58$
- Propanal arises from the  $\text{CH}_3\text{CH}_2\text{CHO}^+$  ion which has a molecular mass of 58
- Butanal arises from the  $\text{CH}_3\text{CH}_2\text{CH}_2\text{CHO}^+$  ion which has a molecular mass of 72

- The molecular ion peak can be used to identify the **molecular mass** of a compound
- However, different compounds may have the same molecular mass
- To further determine the structure of the unknown compound, **fragmentation analysis** is used
- Fragments may appear due to the formation of **characteristic fragments** or the **loss of small molecules**
  - For example, a peak at 29 is due to the characteristic fragment  $\text{C}_2\text{H}_5^+$
  - Loss of small molecules gives rise to differences between peaks of, for example, 18 ( $\text{H}_2\text{O}$ ), 28 ( $\text{CO}$ ), and 44 ( $\text{CO}_2$ )
  - An alcohol can typically dehydrate in a MS, so one peak to look for is  $M-18$

### Alkanes

- Simple alkanes are fragmented in mass spectroscopy by breaking the C-C bonds

- $m/z$  values of some of the common alkane fragments are given in the table below

**$m/z$  values of fragments table**

Fragment	$m/z$
$\text{CH}_3^+$	15
$\text{C}_2\text{H}_5^+$	29
$\text{C}_3\text{H}_7^+$	43
$\text{C}_4\text{H}_9^+$	57
$\text{C}_5\text{H}_{11}^+$	71
$\text{C}_6\text{H}_{13}^+$	85

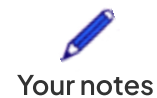

**Fragmentation in a mass spectrum**

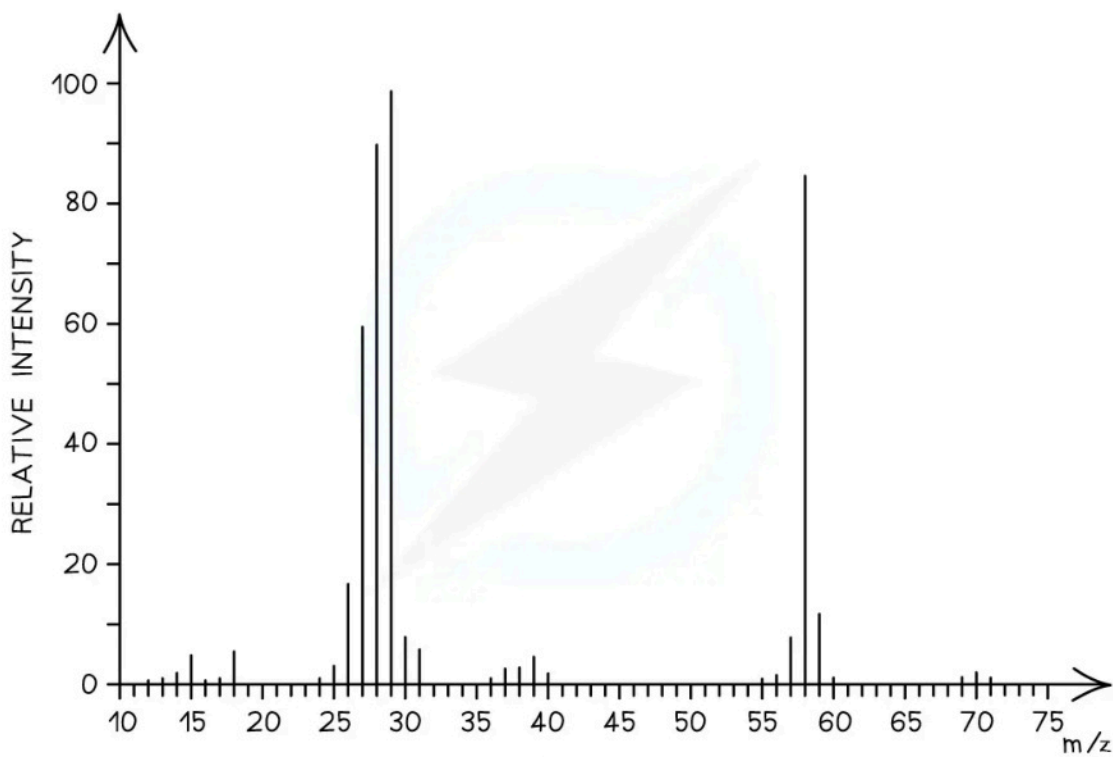

Copyright © Save My Exams. All Rights Reserved

## Mass spectrum showing fragmentation of alkanes



Your notes

## Alcohols

- Alcohols often tend to lose a **water molecule** giving rise to a peak at **18 below the molecular ion**
- Another common peak is found at  $m/e$  value 31 which corresponds to the  $\text{CH}_2\text{OH}^+$  fragment
  - Loss of  $\text{H}^\bullet$  to form a  $\text{C}_3\text{H}_7\text{O}^+$  fragment with  $m/e = 59$
  - Loss of a water molecule to form a  $\text{C}_3\text{H}_6^+$  fragment with  $m/e = 42$
  - Loss of a  $\cdot\text{C}_2\text{H}_5$  to form a  $\text{CH}_2\text{OH}^+$  fragment with  $m/e = 31$
  - And the loss of  $\cdot\text{CH}_2\text{OH}$  to form a  $\text{C}_2\text{H}_5^+$  fragment with  $m/e = 29$
- For example, the mass spectrum of propan-1-ol shows that the compound has fragmented in four different ways:

## Fragmentation in a mass spectrum

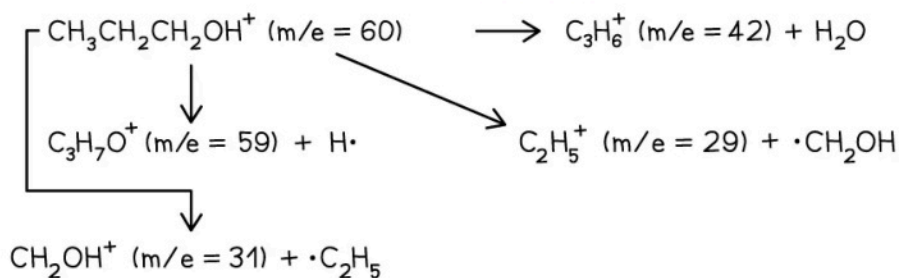
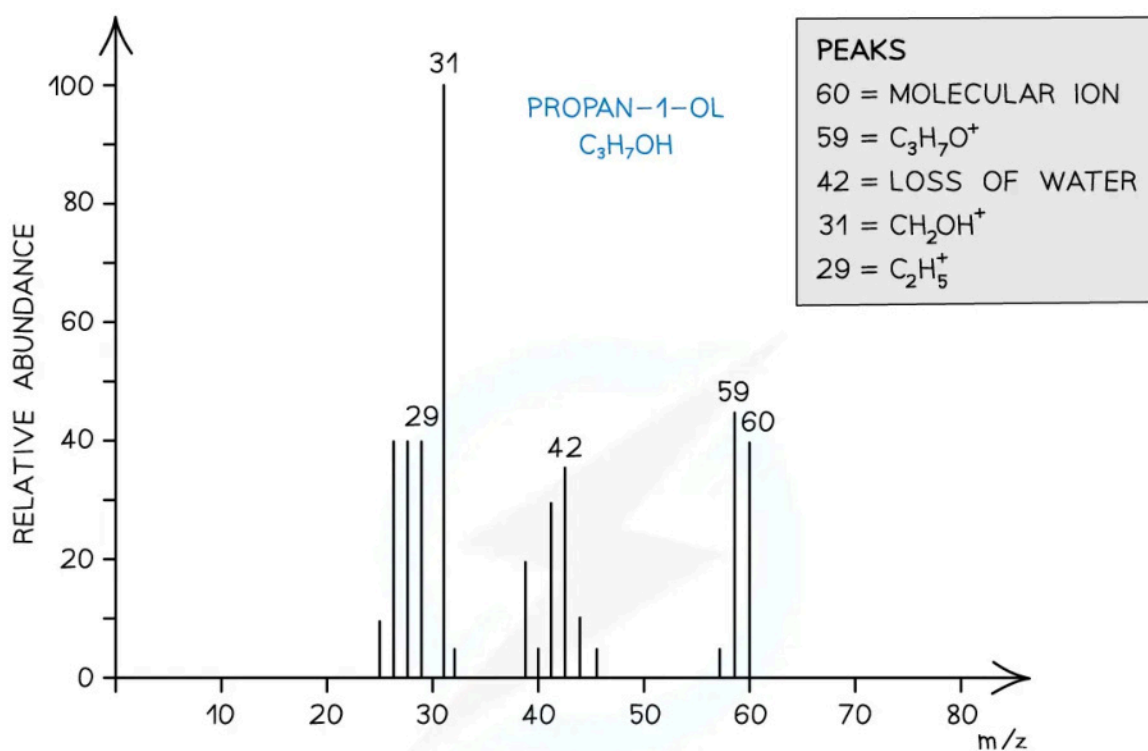

Copyright © Save My Exams. All Rights Reserved

The mass spectrum of propan-1-ol shows that the compound has fragmented in four different ways



Your notes

### Worked example

#### Alcohol fragmentation

Which alcohol is not likely to have a fragment ion at  $m/z$  at 43 in its mass spectrum?

- A**  $(\text{CH}_3)_2\text{CHCH}_2\text{OH}$
- B**  $\text{CH}_3\text{CH}(\text{OH})\text{CH}_2\text{CH}_2\text{CH}_3$
- C**  $\text{CH}_3\text{CH}_2\text{CH}_2\text{CH}_2\text{OH}$
- D**  $\text{CH}_3\text{CH}_2\text{CH}(\text{OH})\text{CH}_3$

#### Answer

The correct answer is option **D**

- Because a line at  $m/z = 43$  corresponds to an ion with a mass of 43 for example:
  - $[\text{CH}_3\text{CH}_2\text{CH}_2]^+$
  - $[(\text{CH}_3)_2\text{CH}]^+$
- 2-butanol is not likely to have a fragment at  $m/z = 43$  as it does not have either of these fragments in its structure.





Your notes

## Infrared Spectra (IR) Interpretation (HL)

### Infrared Spectra (IR) Interpretation

- All **covalent bonds** act rather like springs, as opposed to rigid bars
- Like springs, the bonds can vibrate in a number of different ways
- The frequency of vibration occurs in the **infra-red region** of the **electromagnetic spectrum**
- If an organic molecule is irradiated with **infra-red energy** that matches the **natural vibration frequency** of its bonds, it absorbs some of that energy and the amplitude of vibration increases
- This is known as **resonance**

#### Different modes of bond vibration

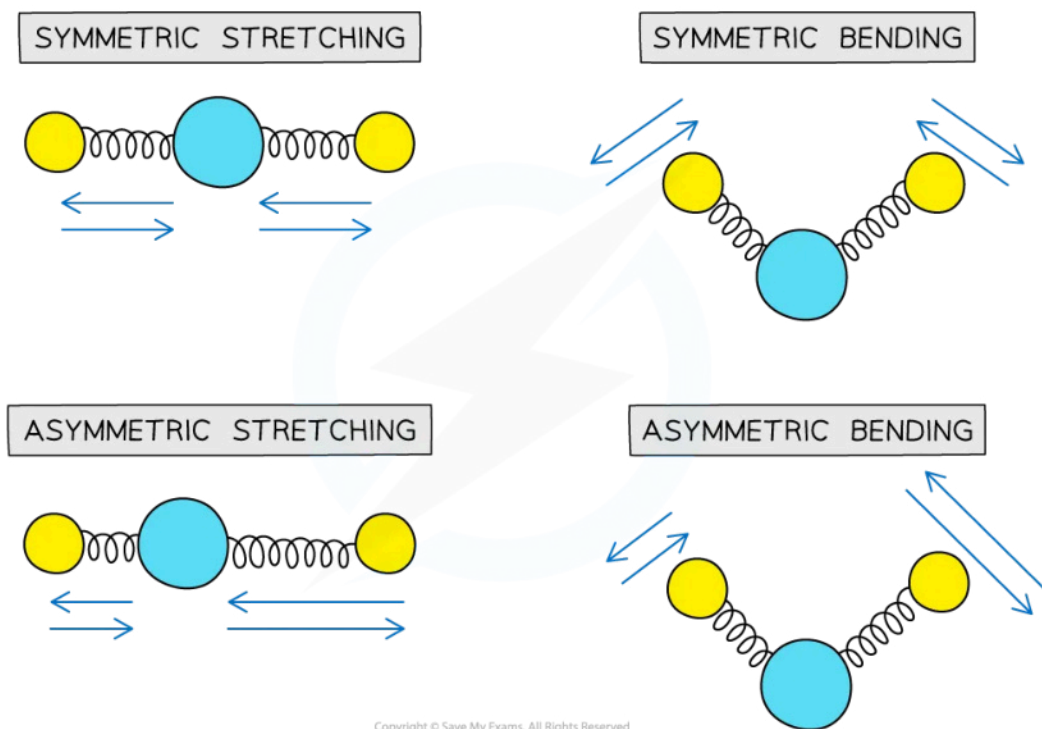

*Different modes of vibration in molecules. Each mode has a characteristic frequency of vibration*

### Infrared (IR) spectroscopy

- Infrared (IR) spectroscopy** is a technique used to identify compounds based on changes in **vibrations** of atoms when they **absorb** IR of certain **frequencies**
- A **spectrophotometer** irradiates the sample with IR radiation and then detects the **intensity** of **IR radiation** absorbed by the molecule
- IR energy** is absorbed only if a molecule has a **permanent dipole** that changes as it vibrates
  - Symmetrical molecules such as  $O_2$  or  $H_2$ , are therefore **IR inactive**

- The **resonance frequency** is the specific frequency at which the bonds will vibrate
- Rather than displaying frequency, an **IR spectrum** shows a unit called **wavenumber**
  - **Wavenumber** is the reciprocal of the **wavelength** and has units of  $\text{cm}^{-1}$
- Characteristic absorptions can be matched to specific bonds in molecules
  - This enables chemists to determine the **functional groups** present



### Absorption Range of Bonds

Bond	Functional Groups containing the bond	Characteristic infrared adsorption range in wavenumbers / $\text{cm}^{-1}$
C - O	Hydroxy, ester	1040 - 1300
C = C	Aromatic compound, alkene	1500 - 1680
C = O	Amide,	1640 - 1690
	carbonyl,	1670 - 1740
	carboxyl ester	1710 - 1750
C $\equiv$ N	Nitrile	2200 - 2250
C - H	Alkane	2850 - 2950
N - H	Amines, amide	3300 - 3500
O - H	Carboxyl,	2500 - 3000
	hydroxyl	3200 - 3600

- Due to some absorption bands overlapping each other, other analytical techniques such as **mass spectroscopy** should be used alongside **IR spectroscopy** to identify an unknown compound
- The best way to understand how to interpret an **IR spectrum** is by looking at examples and becoming familiar with the characteristic features of an **IR spectrum**



Your notes

### Worked example

Examine the two spectra shown and determine which one belongs to propan-2-ol and which one belongs to propanone

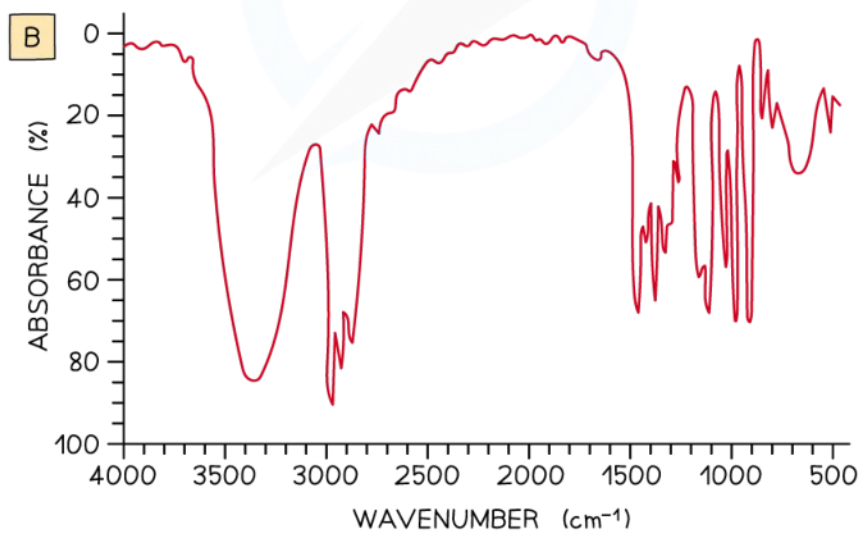
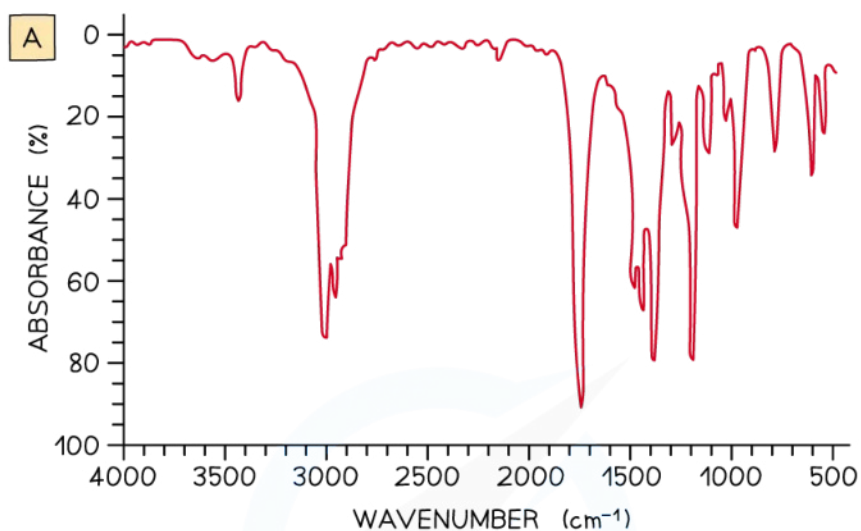

Copyright © Save My Exams. All Rights Reserved

**Answer:**

- IR spectrum **A** is **propanone**
  - In IR spectrum **A** the presence of a strong, sharp absorption around  $1710 \text{ cm}^{-1}$  corresponds to the characteristic  $\text{C}=\text{O}$ , carbonyl group in a ketone
- IR spectrum **B** is **propan-2-ol**.

- In spectrum **B** the presence of a strong, broad absorption around  $3200\text{--}3600\text{ cm}^{-1}$  suggests that there is an alcohol group present, which corresponds to the  $\text{-OH}$  group in propan-2-ol



Your notes

- Infrared spectroscopy is used to identify pollutants in vehicle emissions in the air
  - Sensors detect and measure the amount of pollutants such as carbon monoxide, carbon dioxide and unburnt hydrocarbons
  - This commonly occurs on motorways and in busy town centres to monitor localised pollution
- Infrared spectroscopy can be used to measure alcohol levels using roadside breathalysers
  - A ray of infrared radiation is passed through the breath that is exhaled into the breathalyser chamber
  - The characteristic bonds of ethanol are detected and measured - the higher the absorbance of infrared radiation, the more ethanol in the person's breath

## What are the uses of IR spectroscopy?

### Fingerprint region

- The region below about  $1500\text{ cm}^{-1}$  is called the **fingerprint region** and is unique to every molecule
- It has many peaks that can be difficult to assign
- These peaks represent the complex vibrational interactions that occur between different bonds within a molecule
- The value of the **fingerprint region** is in being able to compare the **IR spectrum** to a known compound from a database and coming up with an exact match
- This is particularly useful, for example, in identifying a specific member of a **homologous series**
  - All members of the series will show the same type of bonds present, but no two molecules will have the same fingerprint region

### Examiner Tip

You can be asked to interpret or predict infrared spectra of both familiar and unfamiliar substances

Three of the key peaks to be aware of are:

1. The narrow scoop caused by the O-H bond of an alcohol at between  $3200$  and  $3600\text{ cm}^{-1}$
2. The sharp spike caused by the carbonyl C=O bond that belongs to many compounds as listed in the data booklet and table above
3. The broad scoop caused by the O-H bond of a carboxylic acid between  $2500$  and  $3300\text{ cm}^{-1}$ , the right hand side of this peak is often distorted by the peaks from C-H bonds

Infrared data is found in Section 26 of the IB Chemistry Data Booklet so there is no need to learn specific wavenumber ranges of bonds



Your notes

## Proton NMR Spectroscopy (HL)

### Proton NMR Spectroscopy

- **Nuclear Magnetic Resonance (NMR)** spectroscopy is used for analysing organic compounds
- Only atoms with **odd mass numbers** show signals on **NMR** spectra and have the property of **nuclear spin**
- In  **$^1\text{H}$  NMR**, the magnetic field strengths of protons in organic compounds are measured and recorded on a spectrum
- Samples are irradiated with radio frequency energy while subjected to a strong magnetic field
- The nuclei can align themselves with or against the magnetic field
- Protons on different parts of a molecule (in different molecular environments) absorb and emit (**resonate**) different radio frequencies
- All samples are measured against a reference compound – **Tetramethylsilane (TMS)**
  - TMS shows a single sharp peak on an **NMR** spectrum, at a value of zero
  - Sample peaks are then plotted as a 'shift' away from this reference peak
  - This gives rise to 'chemical shift' values for protons on the sample compound
  - Chemical shifts are measured in **parts per million (ppm)**

### Features of an NMR spectrum

- An **NMR** spectrum shows the intensity of each peak against their chemical shift
- The area under each peak is proportional to the number of protons in a particular environment
- The height of each peak shows the intensity/absorption from protons

### Low resolution proton NMR

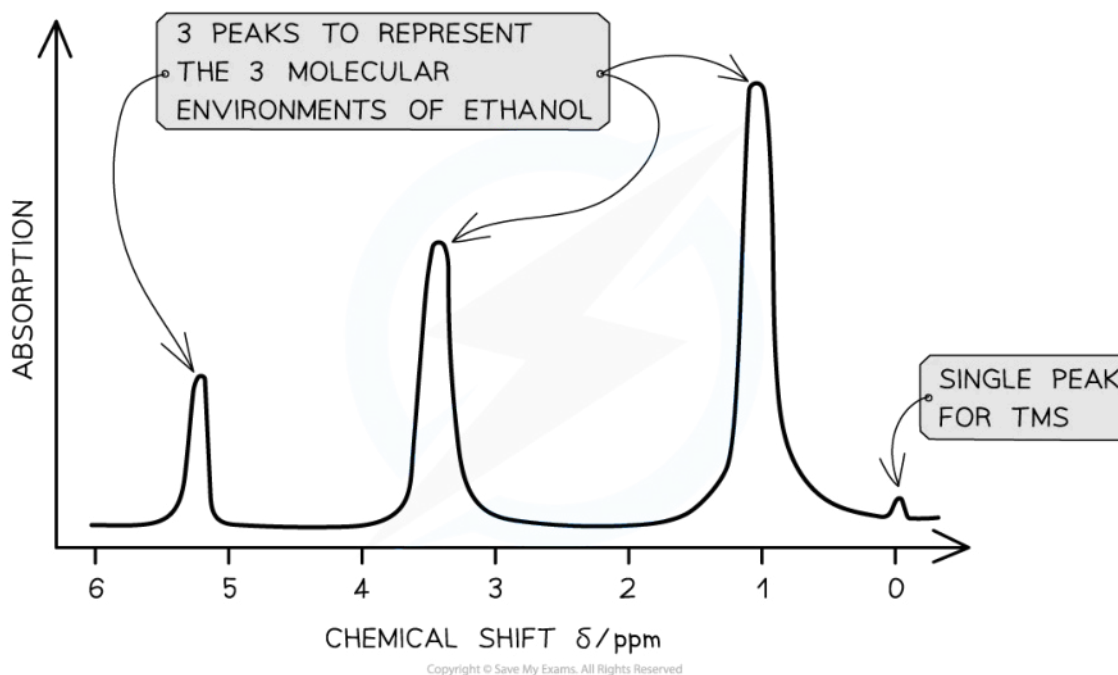

*A low resolution  $^1\text{H}$  NMR for ethanol showing the key features of a spectrum*

## Chemical environments

- Hydrogen atoms of an organic compound are said to reside in different chemical environments
- Eg. Methanol has the molecular formula  $\text{CH}_3\text{OH}$
- There are 2 environments:  $-\text{CH}_3$  and  $-\text{OH}$
- The hydrogen atoms in these environments will appear at 2 different chemical shifts
- Different types of protons are given their own range of chemical shifts

### $^1\text{H}$ NMR Chemical Shifts

Functional group	Type of proton	Chemical shift / ppm
Aldehyde	HCOR	9.3 - 10.5
Alcohol	ROH	0.5 - 6.0
Phenol	Ar - OH	4.5 - 7.0
Carboxylic acid	RCOOH	9.0 - 13.0
Alkyl amine	R - NH -	1.0 - 5.0

Aryl amine	Ar - NH <sub>2</sub>	3.0 - 6.0
Amide	RCONHR	5.0 - 12.0



Your notes

### Examiner Tip

Typical proton chemical shift values are given in Section 27 of the IB Chemistry Data Booklet. The values alone do not identify specific protons as the values occur over a range that is sometimes overlapping, but they can be used in combination with other structural information to help confirm a feature

- Protons in the same environment are chemically equivalent
- Each peak on an NMR spectrum relates to protons in the same environment
- Peaks on a low resolution NMR spectrum refer to environments of an organic compound
  - E.g. Ethanol has the molecular formula CH<sub>3</sub>CH<sub>2</sub>OH
  - This molecule has 3 separate environments: -CH<sub>3</sub>, -CH<sub>2</sub>, -OH
  - So 3 peaks would be seen on its spectrum at 1.2 ppm (-CH<sub>3</sub>), 3.7 ppm (-CH<sub>2</sub>) and 5.4 ppm (-OH)

#### Low resolution proton NMR of ethanol

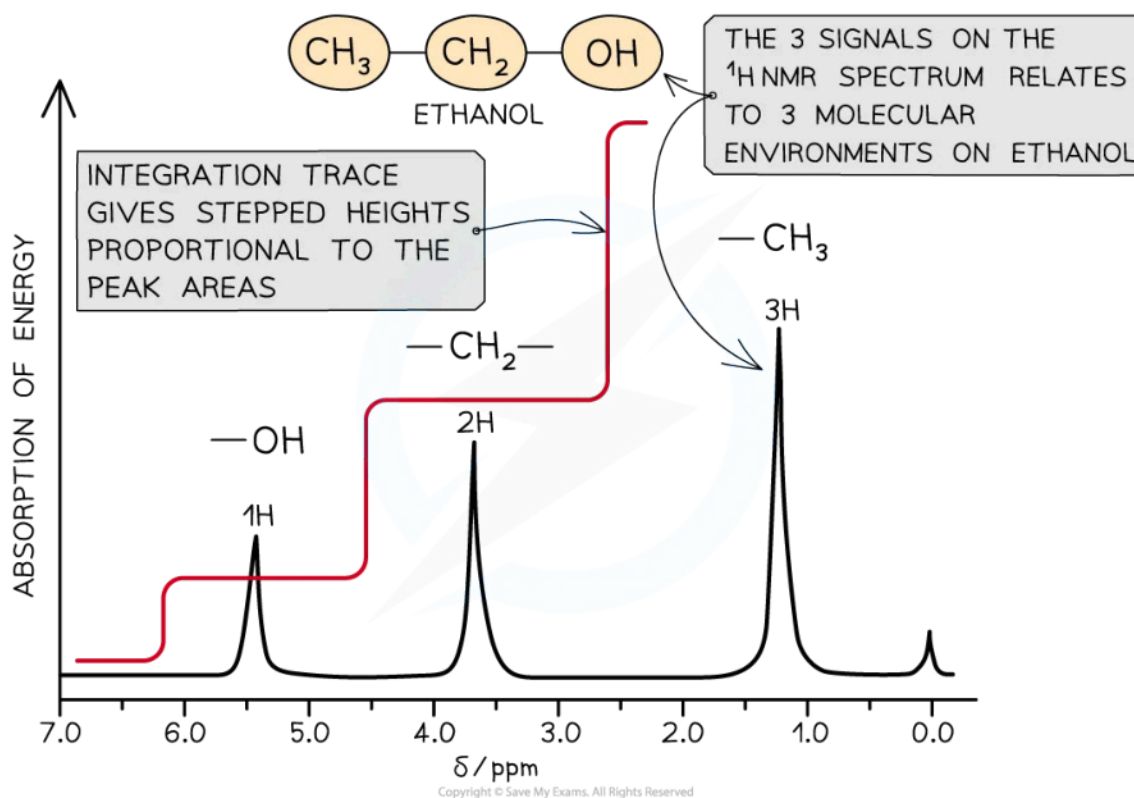

**Three signals are observed in the low resolution proton NMR of ethanol which correspond to three molecular environments**

- The area under each peak is determined by computer and an **integration trace** overlaid on the spectrum
- The **integration trace** has stepped lines whose steps are in the same proportion as the peak areas
- This makes it easier to determine the relative abundance of the different proton environments



### Worked example

Which of the following features can be found from a  $^1\text{H}$  NMR spectrum?

- A The total mass of hydrogen atoms present
- B The number of different hydrogen environments
- C The frequency vibration of C–O bonds
- D The first ionisation energy of hydrogen

**Answer:**

The correct option is **B**

- An NMR spectrum can tell you about the type of hydrogen environments and the relative proportion of the hydrogens in those environments



Your notes



Your notes

## Peak Splitting in Proton NMR (HL)

### Peak Splitting in Proton NMR

- In the first part of **NMR spectroscopy**, we have seen that the nuclei of H atoms behave as tiny magnets and can interact with an applied magnetic field
- Only atoms with **odd mass numbers** show signals on NMR spectra and have the property of **nuclear spin**

Table showing nuclei which possess spin

Nuclei	Protons	Neutrons	Spin
$^1\text{H}$	1	0	✓
$^2\text{H}$	1	1	X
$^{12}\text{C}$	6	6	X
$^{13}\text{C}$	6	7	✓
$^{19}\text{F}$	9	10	✓
$^{31}\text{P}$	15	16	✓

- They can align themselves with the external magnetic field (lower energy state) or against the external field (higher energy state)
- Energy from the radio frequency end of the electromagnetic spectrum can excite the nuclei and cause them to 'flip' between a lower and higher energy state - this is **resonance**
- Samples are irradiated with radio frequency energy while subjected to a strong magnetic field
- Protons on different parts of a molecule (in different molecular environments) absorb and emit (**resonate**) different radio frequencies
- The magnetic field strengths of protons in organic compounds are measured and recorded on a spectrum
- The **resonance energy** is unique to specific H atoms in molecules that are located in the same chemical environment
- Information from the spectrum tells us the number of different H environments
- A reminder about low resolution NMR:

#### Low resolution $^1\text{H}$ NMR of ethanol

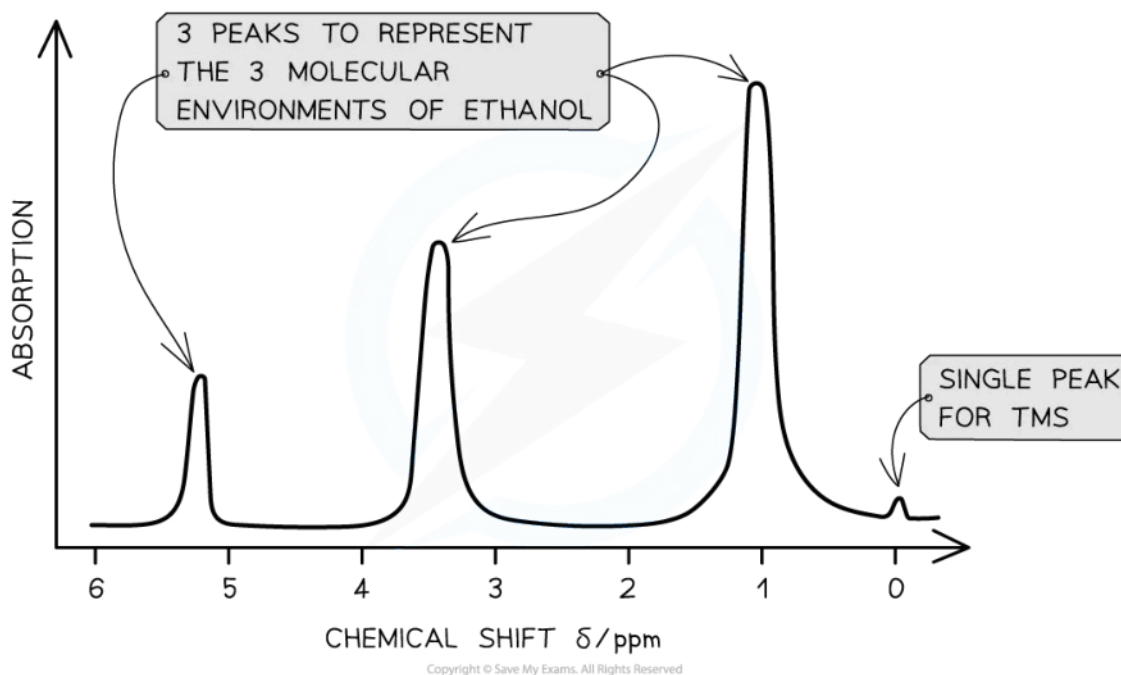

A low resolution  $^1\text{H}$  NMR for ethanol showing the key features of a spectrum

## Tetramethylsilane

- The horizontal scale on an NMR spectrum represents **chemical shift ( $\delta$ )**
- Chemical shift is measured in parts per million (ppm) of the magnetic field strength needed for resonance in a reference chemical called tetramethylsilane, abbreviated to **TMS**

### Structural formula of tetramethylsilane

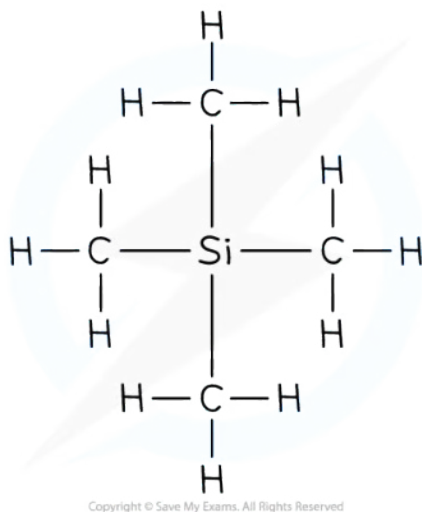

### The displayed formula of tetramethylsilane

- TMS is used universally as the reference compound for NMR as its methyl groups are particularly well shielded and so it produces a strong, single peak at the far right of an NMR spectrum
- The signal from the carbon atoms in TMS is defined as having a chemical shift of 0 ppm

### Reference peak

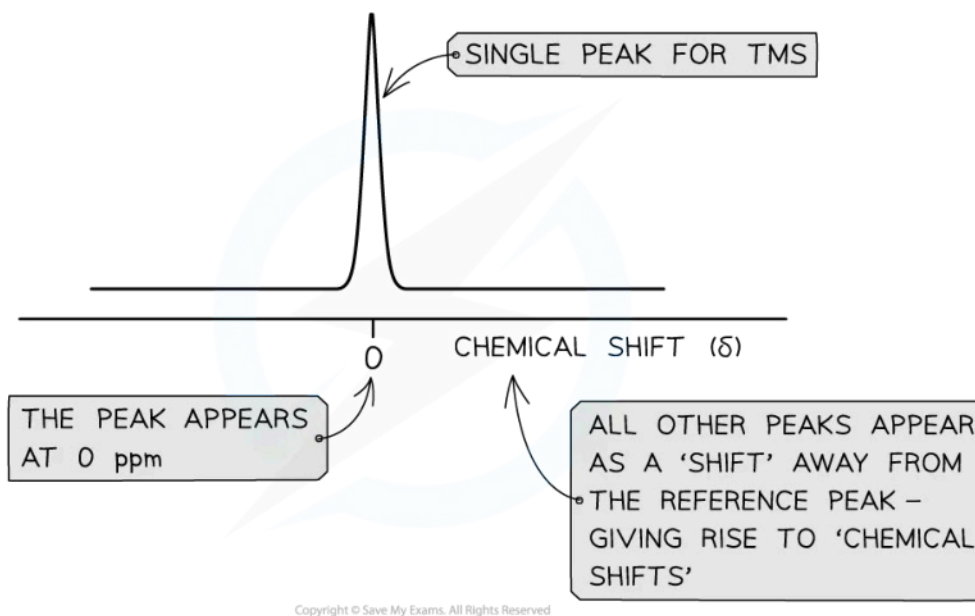

### The NMR reference peak for TMS

## Chemical Shift

- The chemical shift values of peaks on an  $^1\text{H}$  NMR spectrum give information about the likely types of proton environment in a compound

### Chemical shift



Your notes

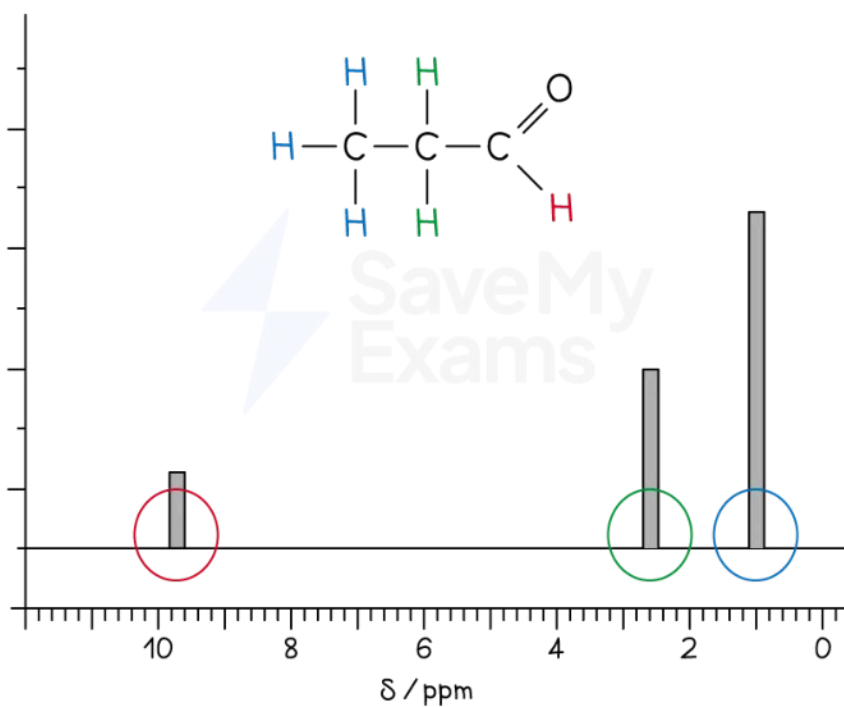

### <sup>1</sup>H NMR Chemical Shift

Type of proton	Chemical shift / $\delta$ ppm
$-\text{CH}_3$	0.9-1.0
$\begin{array}{c} \text{O} \\ \parallel \\ \text{R}-\text{C}-\text{CH}_2- \end{array}$	2.2-2.7
$\begin{array}{c} \text{O} \\ \parallel \\ \text{R}-\text{C}-\text{H} \end{array}$	9.4-10.0

*The chemical shift values can be used to identify specific proton environments*



Your notes

## Peak Splitting

- High resolution NMR gives more complex signals giving more structural details
- The signals sometimes appear to be split into a number of sub-peaks called doublets, triplets and quartets
  - This is known as **multiplicity**
- The splitting pattern of each peak is determined by the number of protons in neighbouring environments
- The complex signal produced indicates the number of protons on adjacent carbon atoms
- Neighbouring protons produce weak magnetic fields that can interact with each other
- Depending on how that interaction takes place, it allows you to determine the number of neighbouring protons
- Suppose you have a particular viewpoint on an issue
  - You ask your neighbour's opinion
  - Your neighbour could reinforce your argument and make your belief stronger
  - Alternatively, your neighbour could contradict your argument and make it weaker

### The NMR reference peak for TMS

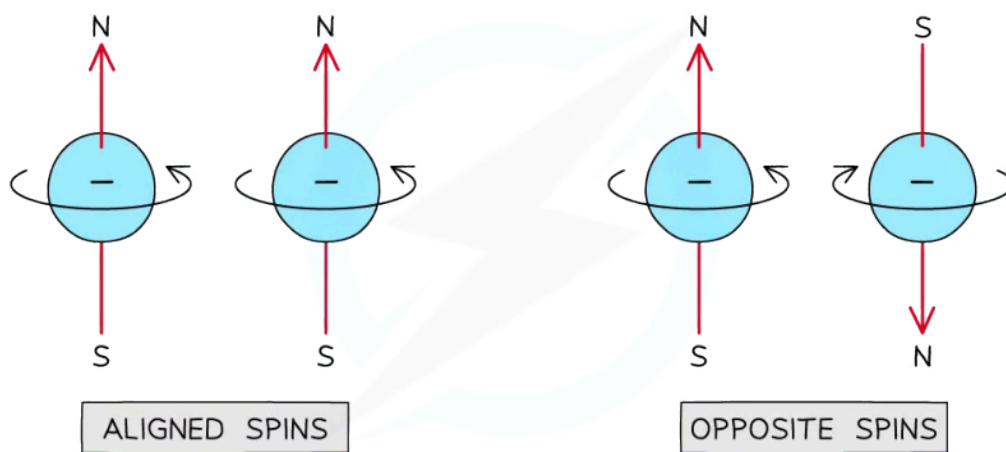

### Aligned and opposite spins on neighbouring protons

- If the spin of a neighbouring proton is aligned with the spin of the proton in question, the magnetic field from this spin strengthens the magnetic field
  - The resonance is stronger and results in a slightly higher chemical shift
- The magnetic field from the spin on a neighbouring proton that spins against the first proton weakens the magnetic field
  - The resonance is weaker and results in a slightly lower chemical shift
- The resulting high resolution NMR peak shows a split into a doublet - two equal peaks
- This pattern can only be obtained when there is one neighbouring proton so it gives us useful information about the structure of the molecule

- When there are two neighbouring protons, there are four possible combinations, but two of them have the same outcome on field strength, so three separate peaks are obtained

**Table showing the effect of two neighbouring protons on peak splitting**

First neighbour	Second neighbour	Field strength	Frequency
+	+	stronger	1
+	-	unchanged	2
-	+	unchanged	
-	-	weaker	2

- The resulting peak is split as a triplet
- This is what is seen when a proton is next to a  $\text{-CH}_2\text{-}$  group
- When there are three neighbouring protons, there are eight possible combinations, four with the same outcome, so four separate peaks are seen, called a quartet
- This is what is seen when a proton is next to a  $\text{-CH}_3$  group, in other words, a proton that is next to the end of a chain
- The number of split peaks is related to the neighbours following what is termed the **n+1 rule**
  - Where there are n neighbours there are n+1 split peaks

 **$^1\text{H}$  NMR peak splitting patterns table**

Number of adjacent protons (n)	Splitting pattern using the n+1 rule the peak will split into ....	Relative intensities in splitting pattern	Shape
0	1, singlet	1	



Your notes

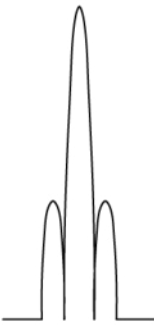
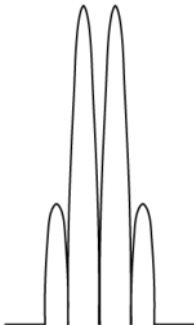

Your notes

1	2, doublet	1:1	
2	3, triplet	1:2:1	
3	4, quartet	1:3:3:1	

- In summary, an NMR spectrum provides several types of information
  - number of **signal groups**... ..the number of **different proton environments**
  - chemical shift**... ..the **general environment** of the protons
  - peak area**... ..the **relative number of protons** in each environment
  - multiplicity**... ..how many **protons** are on **adjacent atoms**
- In many cases, this information is sufficient to deduce the structure of an organic molecule but other forms of spectroscopy are used in conjunction with NMR to confirm structural information





Your notes

## Structural Analysis of Molecules (HL)

### Structural Analysis of Molecules

- The chemists' toolkit includes a range of analytical techniques that enable the structure of compounds to be deduced

Summary table of analytical techniques

Technique	Information provided
Mass spectrometry	Relative atomic mass Isotopes Relative molecular mass Fragments in organic compounds Structure of organic compounds
Nuclear magnetic spectroscopy	Structure of organic compounds
Infrared spectroscopy	Types of covalent bonds Functional groups

- These techniques are rarely used in isolation, but together provide corroborating evidence for elucidating chemical information on newly discovered or synthetic compounds
- Problem solving typically involves taking multiple pieces of spectroscopic data about the same unknown compound and coming up with a likely structure



Your notes

**Worked example**

An unknown compound, **X**, of molecular formula,  $C_4H_8O$ , has the following MS, IR and  $^1H$  NMR spectra.

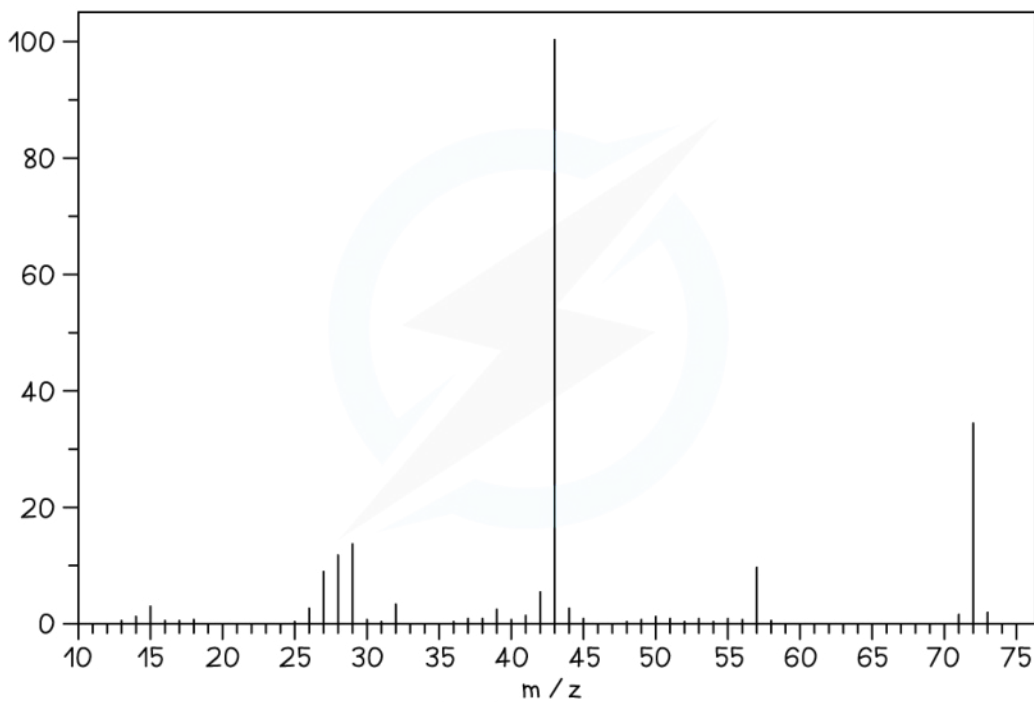

Copyright © Save My Exams. All Rights Reserved

**Mass spectrum of X**

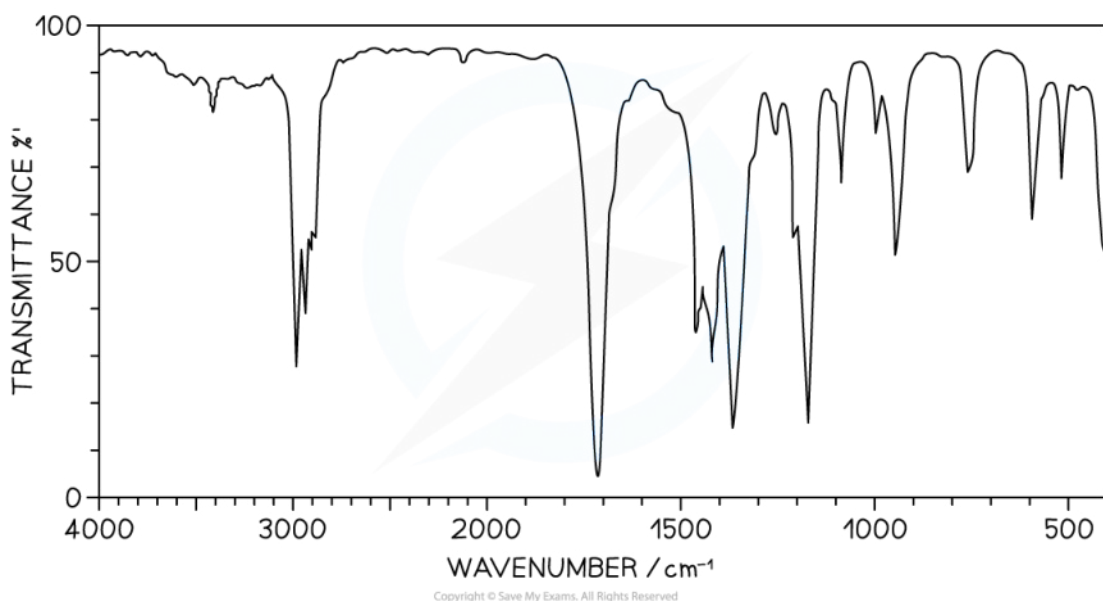

*IR spectrum of X*

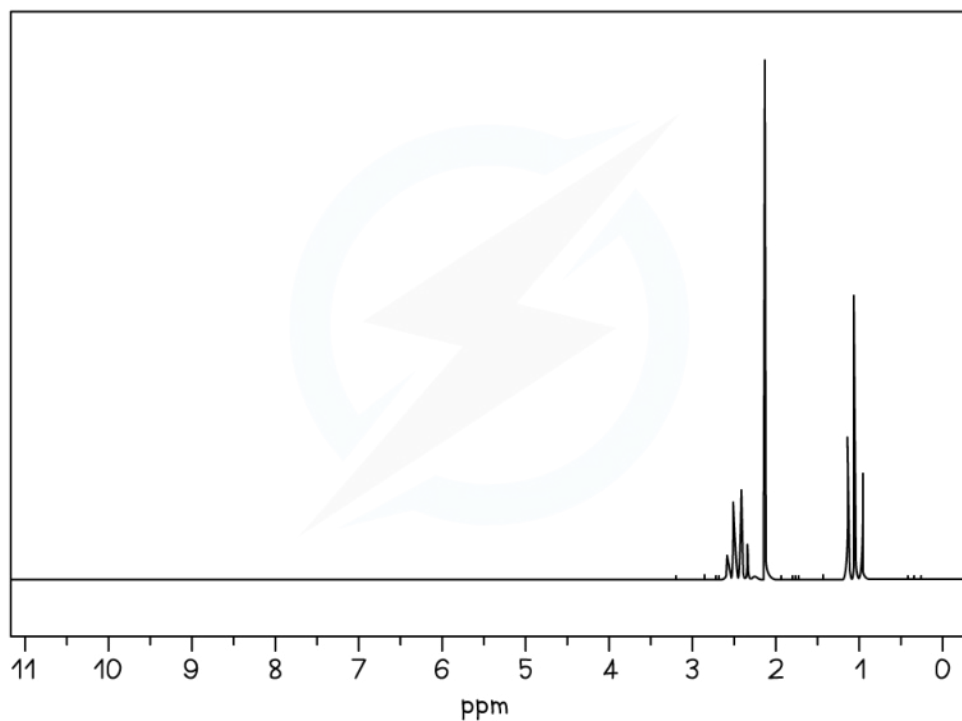

*$^1\text{H}$  NMR spectrum of X*



Your notes

Deduce the structure of **X** using the information given and any other additional information in the Data booklet. For each spectrum assign as much spectroscopic information as possible.

### Answer

#### Mass Spectrum (Section 22 of the data booklet)

- The molecular ion peak is at  $m/z = 72$ , which corresponds to the relative molecular mass of  $C_4H_8O$ 
  - $M_r = (12 \times 4) + (8 \times 1) + (16) = 72$
- The large peak at  $m/z = 43$  could correspond to  $CH_3CH_2CH_2^+$  or  $CH_3CO^+$  indicating the loss of  $CH_4O$  or  $C_2H_5$  from **X**, that is ( $M_r - 43$ )
- The peak at  $m/z = 29$  could correspond to  $CH_3CH_2^+$  indicating the loss of  $C_2H_3O$  from **X**, that is ( $M_r - 29$ )

#### IR Spectrum (Section 20 of the data booklet)

- There is a strong absorption in the range  $1700 - 1750 \text{ cm}^{-1}$  which corresponds to  $C=O$
- This suggests an aldehyde or ketone is present
  - It cannot be an ester or a carboxylic acid as there is only one oxygen in the formula

#### $^1\text{H}$ NMR Spectrum (Section 21 of the data booklet)

- The  $^1\text{H}$  NMR spectrum shows three proton environments
  - The peak around chemical shift 1.0 ppm could correspond to methyl protons on the end of a chain,  $-\text{CH}_3$
  - The peaks around chemical shift 2.2 - 2.7 ppm could correspond to a proton next to a carbonyl group,  $\text{R}-\text{CH}_2-\text{CO}-$
- The peak splitting is a quartet, singlet and triplet
  - A quartet and triplet in the same spectrum usually corresponds to an ethyl group,  $\text{CH}_3\text{CH}_2$ , following the  $n+1$  rule
  - The singlet indicates an isolated proton environment

#### Overall structure

