



DP IB Biology: HL

Your notes

10.1 Meiosis

Contents

- * 10.1.1 The Process of Meiosis
- * 10.1.2 Crossing Over
- * 10.1.3 Meiosis I
- * 10.1.4 Meiosis II
- * 10.1.5 Skills: Drawing Chiasmata



Your notes

10.1.1 The Process of Meiosis

Replication of Chromosomes

Like mitosis, meiosis is preceded by DNA replication

- Like most other eukaryotic cells, gamete-producing cells perform a **cell cycle**
 - Gamete-producing cells are found in the testes and ovaries
 - The cells that give rise to sperm cells are found in the testes
- If a new sperm-producing cell is being generated in the testes, **mitosis** occurs as with any other diploid body cell
 - The G1, S and G2 stages of the cell cycle proceed
 - The sperm-producing cell undergoes **DNA replication** and the amount of DNA within that cell doubles
 - The cell still contains **2n** number of chromosomes; although each chromosome has doubled in size
- DNA replication also happens before **meiosis**
 - Unlike mitosis, replication in meiosis is followed by **2 rounds** of chromosome separation as opposed to **1 round in mitosis**
- **Hormones** and **other stimuli** trigger cells in the testes to enter **meiosis**; at this stage the sperm-producing cell **ceases to be diploid** and fulfils its function to produce **haploid gametes** (spermatids, which then develop into spermatozoa, also known as sperm cells)
 - The triggering of **ova generation** in female mammals is **less well understood** because of the different times of a female mammal's life when eggs are produced
 - Male mammals tend to produce sperm throughout their adult life

Mitosis or Meiosis?

- Gamete-producing cells are unique in that they can divide by **both well-known cell division routes**
- Considering a sperm-producing cell as an example, it has two possible routes of cell division
 - Mitosis - to **regenerate** itself and during **growth** of the tissue in the testes
 - Like any other somatic cell in this regard
 - Meiosis - to fulfil its specialisation ie. to produce **sperm** (called spermatogenesis) at the required time of the male's life
- Both routes begin with **DNA replication** within the diploid cell's nucleus



Your notes

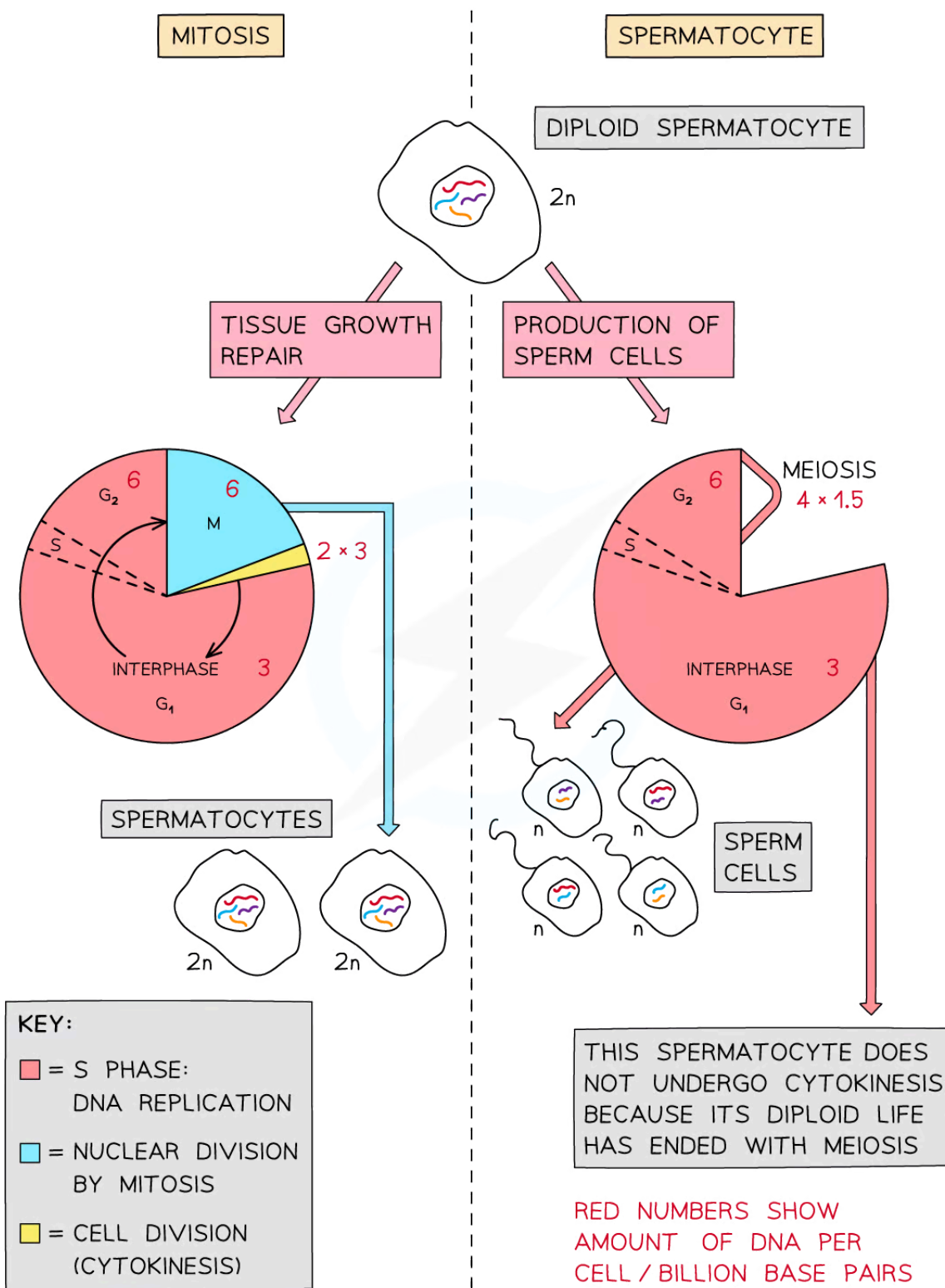

Copyright © Save My Exams. All Rights Reserved

The two possible routes of cell division for a spermatocyte. Both start with DNA replication. The right hand side describes spermatogenesis



Your notes

DNA Replication

- During interphase, the cell increases in mass and size and carries out its **normal cellular functions**
 - eg. **synthesising proteins** and the reactions of **respiration**
- Interphase consists of three phases:
 - G1 phase
 - S phase
 - G2 phase
- During interphase the DNA in the nucleus **replicates**, after which each chromosome consists of two identical sister **chromatids**
 - This phase of interphase during which DNA replication occurs is called the S phase – S stands for synthesis (of DNA)

Following DNA replication, the fate of the sperm-producing cell is determined by hormonal and other stimuli

- If the male is sexually mature, **some cells in the testes will enter meiosis** and begin producing sperm
 - The individual **sperm-producing cell ceases to exist** when it enters meiosis
- Other sperm-producing cells will divide by mitosis
 - To ensure a **healthy population** of sperm-producing cells for future sperm production
 - A sperm-producing cell retains its identity by this route



Your notes

The Process of Meiosis

Overview of Meiosis

- Meiosis is a form of nuclear division that results in the production of haploid cells from diploid cells
- It produces gametes in plants and animals that are used in **sexual reproduction**
- It has many similarities to mitosis but it has two successive divisions: **meiosis I** and **meiosis II**
- As with mitosis, within each division there are four stages; prophase, metaphase, anaphase and telophase
- Meiosis occurs:
 - In the **testes** of male animals and the **ovaries** of female animals
 - In the **anthers** and **ovaries** of flowering plants
- Meiosis leads to the production of the following haploid gametes:
 - Spermatozoa**, or **sperm cells**, in male animals, **ova** (singular ovum) in female animals
 - Male plant gametes are carried in **pollen** grains and female plants gametes are held in the **ovules** within the plant ovary.

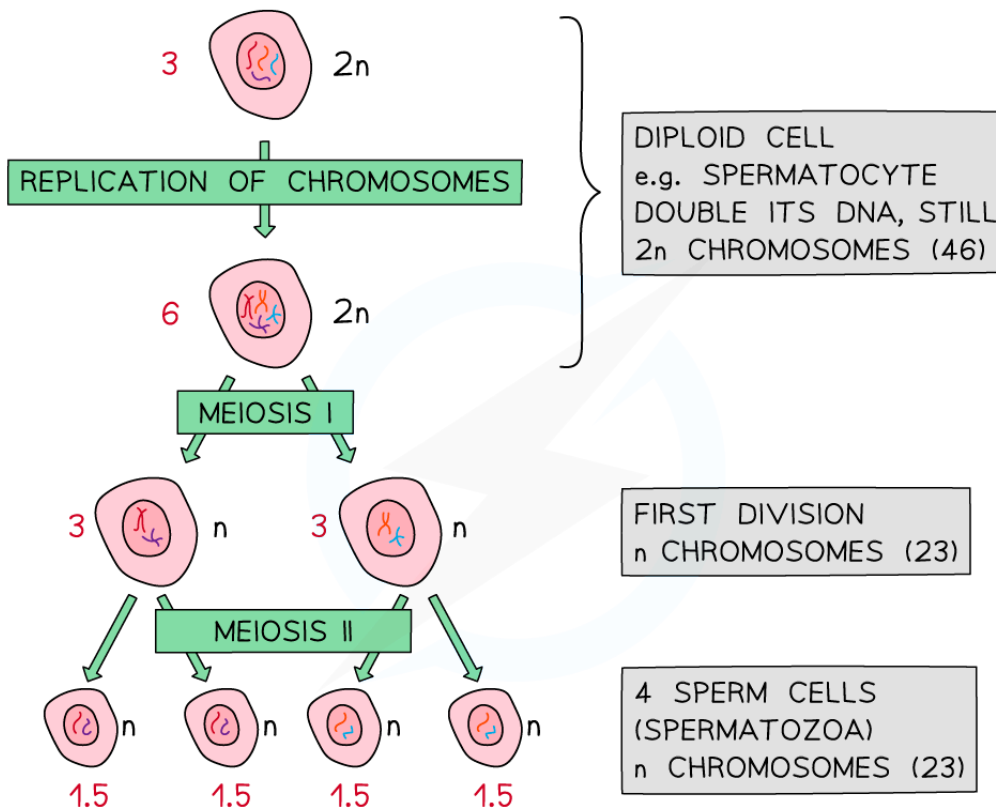

RED NUMBERS SHOW APPROX. NUMBER OF
BASE PAIRS OF DNA IN EACH CELL / BILLIONS

Copyright © Save My Exams. All Rights Reserved



Your notes

Overview of meiosis, showing chromosome numbers and quantities of DNA present in each cell in humans (*Homo sapiens*)

Formation of Bivalents

- After DNA replication, the first step of the meiotic pathway (prophase I), is that the chromosomes **condense**
 - This means that they shorten, become denser and so **become visible**
 - Condensation separates the jumble of chromatin in the nucleus and allows the chromosomes to segregate properly later, in meiosis
- Each chromosome is visible as a pair of chromatids
 - **Sister chromatids** are so-called because they originate from the same parent
 - This is **not a reference to gender/sex** chromosomes
 - Two homologous chromosomes (exact copies of each other) align alongside to each other
 - This is called a **bivalent** because it is composed of **two** chromosomes
 - It is also called a **tetrad** because it is composed of **four** chromatids
 - This process is called synapsis
- An example of a bivalent would be for human chromosome number 11 (see image below)
- The original chromosome pair 11 has one chromosome no. 11 inherited from the **paternal** line i.e. from the organism's father and one no. 11 chromosome from the **maternal** line
 - Each chromosome 11 copies itself in interphase
 - So there are 2 identical copies of paternal chromosome 11
 - And 2 identical copies of maternal chromosome 11
 - Such a bivalent is also a **tetrad** because each of the two copies of chromosome 11 is made up of 2 chromatids, making 4 chromatids in total

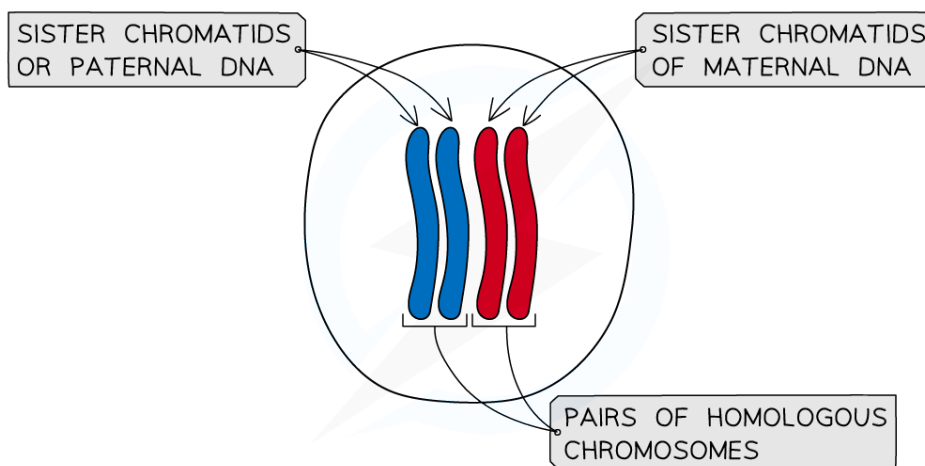

Copyright © Save My Exams. All Rights Reserved

Examiner Tip

The cells of the sex organs can divide by both mitosis and meiosis, while other body cells (aka somatic cells) only divide by mitosis.

'Cell division' is sometimes a confusing term because that implies that DNA is being 'divided' between cells. This IS strictly true, although in order for there to be enough DNA for the new cells, DNA has to replicate itself first.

To aid fluency in exam answers, write a glossary or flashcards of the following terms so you can always choose the right the keywords in your written answers: allele; bivalent; centromere; chromosome; chromatid; gene loci; homologous pair; synapsis; tetrad.



Your notes



Your notes

10.1.2 Crossing Over

Crossing Over

Crossing over is the exchange of DNA material between non-sister homologous chromatids

- Meiosis has several mechanisms that **increase the genetic diversity of gametes** produced
- Both **crossing over** and **independent assortment** (sometimes also called **random orientation**) result in different combinations of alleles in gametes

What are non-sister chromatids?

- In a diploid cell, each homologous pair of chromosomes consists of one chromosome that originated from the organism's father, and one from the mother
- During replication prior to meiosis, each chromosome copies to form a **bivalent**
- The **chromatids align in prophase I**, during which paternal chromatids and maternal ones can line up directly against each other
- If a pair of adjacent chromatids are originated from two different parental chromosomes, they are called **non-sister chromatids**
 - As such, they carry the same genes but can carry different alleles



Your notes

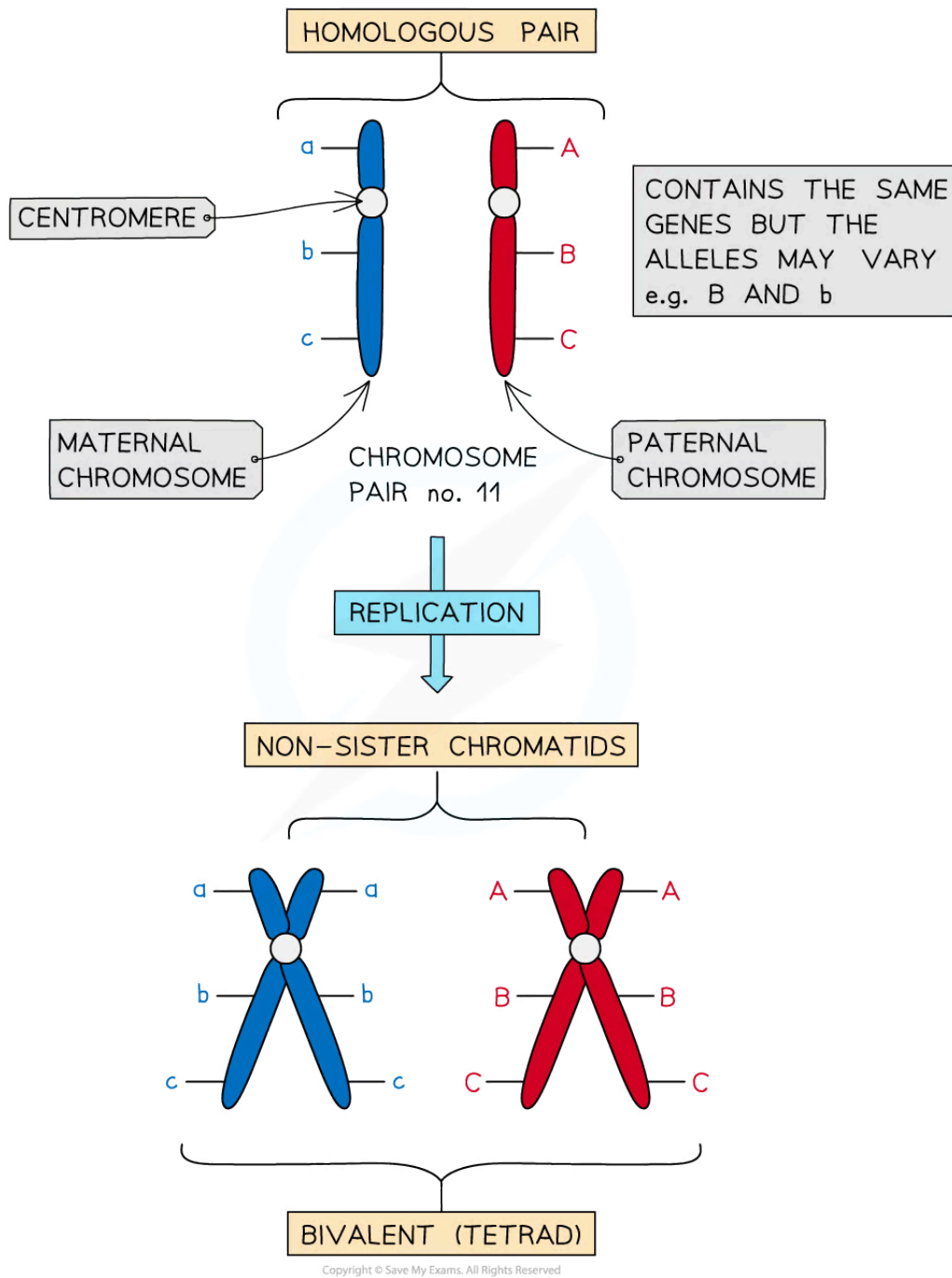

Non-sister chromatids originate from different parents' chromosomes and align during prophase 1



Your notes

Chiasmata Formation

Crossing over

- Crossing over is the process by which **non-sister chromatids exchange alleles**
- Process:
 - During prophase I, homologous chromosomes pair up and are in **very close proximity** to each other
 - The non-sister chromatids can **get entangled** and 'cross over' each other
 - The entanglement places **stress on the DNA molecules**
 - As a result of this molecular stress, a section of chromatid from one chromosome may **break and re-join** with the chromatid from the other chromosome
 - The breaking and re-joining is catalysed by **endonuclease** and **DNA ligase** enzymes respectively
- This swapping of alleles is significant as it can result in a new combination of alleles on the two chromosomes
- Any process that involves breaking and re-joining of DNA to create new combinations of genetic information is called recombination
 - DNA/chromosomes that have exchanged DNA in this way are referred to as **recombinant**
- When the DNA coils up, DNA strands at the crossing points remain attached to each other, so this causes the chromosome structure to change shape, developing an **X-shaped join**
- These crossing points are called chiasmata (singular: '**chiasma**')
- There is usually at least one, if not more, chiasma present in each bivalent during meiosis
- Crossing over does not just occur between non-sister chromatids that are immediately adjacent to each other
 - Crossing over can occur from one chromatid to either/both chromatids of the adjacent homologous pair

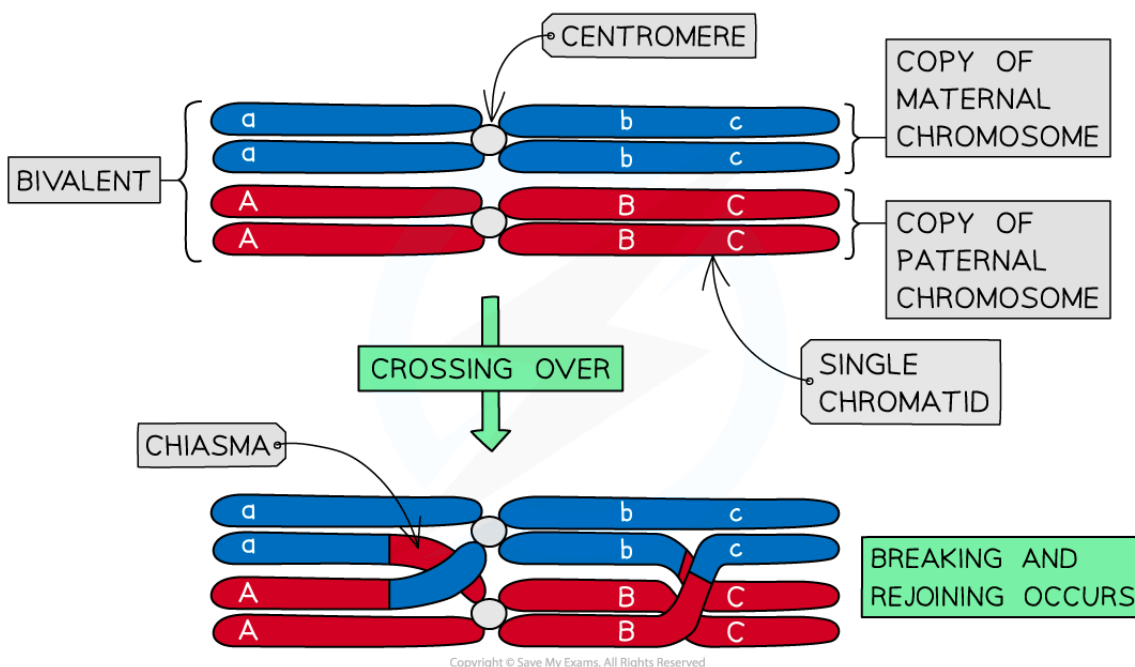

Copyright © Save My Exams. All Rights Reserved

The formation of chiasmata (following synopsis)



Your notes

New Allele Combinations

Crossing over produces new combinations of alleles on the chromosomes of the haploid cells

- So within a bivalent, or tetrad, there are 4 chromatids lying alongside each other and forming chiasmata
- Some of these chromatids will have **exchanged lengths of DNA** with each other at the chiasmata
- Each chromatid from a tetrad separates from the others during meiosis II
- Each chromatid goes on to form a haploid gamete
 - And so a different range of alleles will be carried in each gamete cell
 - This contributes greatly to intraspecific variation
- Back in prophase I, crossing over is more likely to occur further down the chromosome, away from the centromere
 - Because areas of DNA away from the centromere can flail around more, they are more likely to become entangled
 - Gene locus can therefore affect the genotype spread within a population, based on the likelihood of crossing over generating new allele combinations



Your notes



Your notes

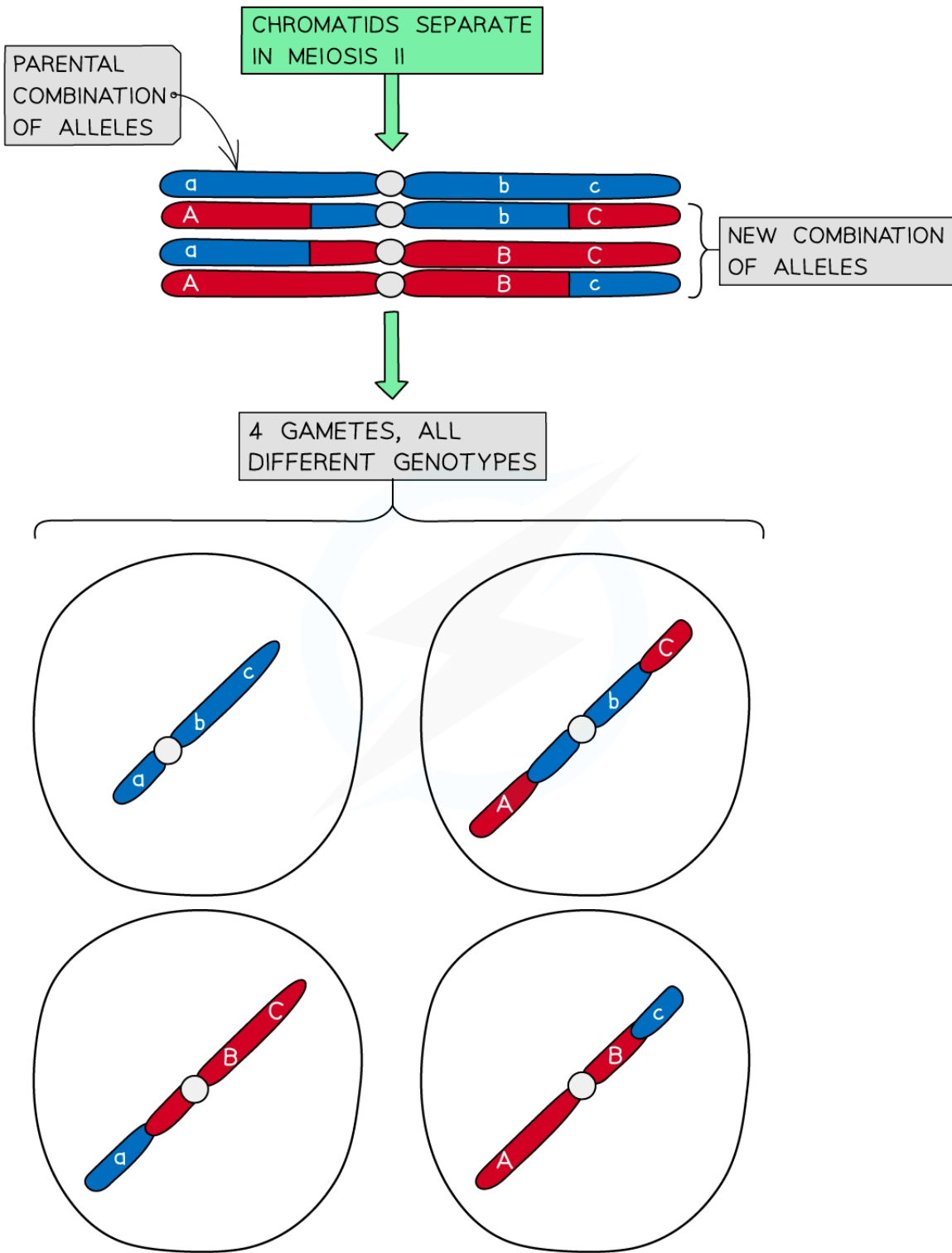

Copyright © Save My Exams. All Rights Reserved

Distinct allele combinations appear in haploid gametes following crossing over

- Because of the random nature of how chromatids align and where they break, there is an almost **infinite range of combinations** of how DNA can recombine during crossing over
 - This explains that even in a very large population, **no two individuals will have exactly the same genotype** (except identical twins)

 **Examiner Tip**

Independent assortment can create a number of combinations that can be calculated. However, crossing over generates an incalculable amount of variation (we can assume it's infinite), just because of the random nature of where chiasmata can form.



Your notes



Your notes

10.1.3 Meiosis I

Meiosis I

Homologous chromosomes separate in meiosis I

Prophase I

- DNA has already replicated and **condenses** and **becomes visible** as chromosomes
- Each chromosome consists of two sister chromatids joined together by a centromere
- The chromosomes are arranged side-by-side in homologous pairs
 - A pair of homologous chromosomes is called a **bivalent**
- As the homologous chromosomes are very close together the crossing over of non-sister chromatids may occur. The point at which the crossing over occurs is called the **chiasma** (chiasmata; plural)
- In this stage **centrioles migrate** to opposite poles and the spindle is formed
- The **nuclear envelope breaks down** and the **nucleolus disintegrates**

Metaphase I

- The **bivalents line up along the equator of the spindle**, with the spindle fibres attached to the centromeres
- The bivalents line up by **independent assortment** (random orientation)

Anaphase I

- The homologous pairs of chromosomes are separated **as microtubules pull whole chromosomes to opposite ends** of the spindle
- The centromeres do not split

Telophase I

- The chromosomes arrive at opposite poles
- Spindle fibres start to break down
- **Nuclear envelopes form** around the two groups of chromosomes and nucleoli reform
- Some plant cells go straight into meiosis II without reformation of the nucleus in telophase I

Meiosis I is reduction division

- Meiosis I is referred to as **reduction division** because homologous chromosomes separate and move to opposite poles of the cell.
- Therefore, the number of chromosomes per cell is **reduced** by a factor of 2



Your notes

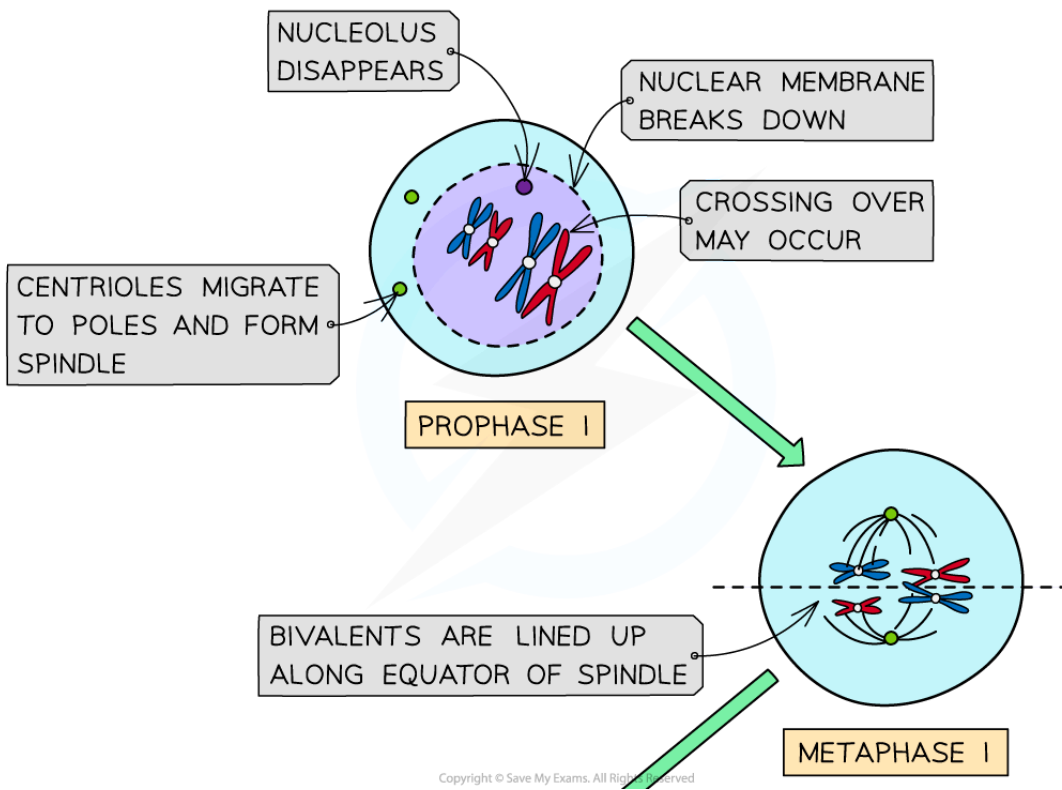



Your notes

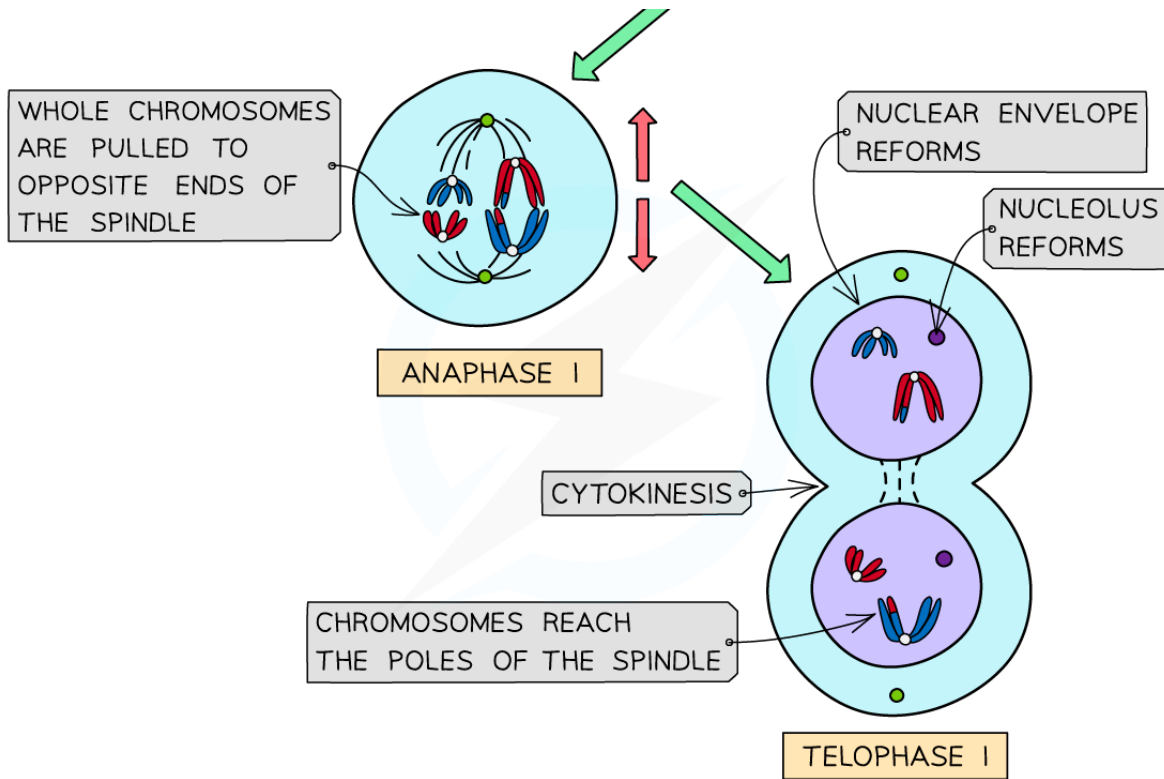

The different stages of meiosis I in an animal cell

 **Examiner Tip**

Understanding the difference between chromosomes and chromatids can be difficult. We count chromosomes by the number of centromeres present. So when the 46 chromosomes duplicate during interphase and the amount of DNA in the cell doubles there are still only 46 chromosomes present because there are still only 46 centromeres present. However, there are now 92 chromatids, which are strands of replicated chromosomes.

Independent Assortment

- During metaphase I, an event occurs that is an important source of genetic variation in the gametes formed by meiosis
- Independent assortment is the **production of different combinations of alleles** in gamete cells due to the random alignment of homologous pairs along the equator of the spindle during metaphase I
 - This random alignment is sometimes referred to as **random orientation**
- In prophase I homologous chromosomes pair up and in metaphase I they are pulled towards the equator of the spindle
 - Each pair can be arranged with either chromosome on top, this is **completely random**
 - The orientation of one homologous pair is independent / unaffected by the orientation of any other pair
- The homologous chromosomes are then separated and pulled apart to different poles during anaphase
- The combination of alleles that end up in each daughter cell **depends on how the pairs of homologous chromosomes were lined up**
- To work out the number of different possible chromosome combinations the formula 2^n can be used, where n corresponds to the number of chromosomes in a haploid cell
- For humans this is 2^{23} which calculates as **8 388 608 different combinations**
 - This may seem like a lot of combinations, but by contrast, **crossing over** introduces an almost infinite amount of variation



Your notes



Your notes

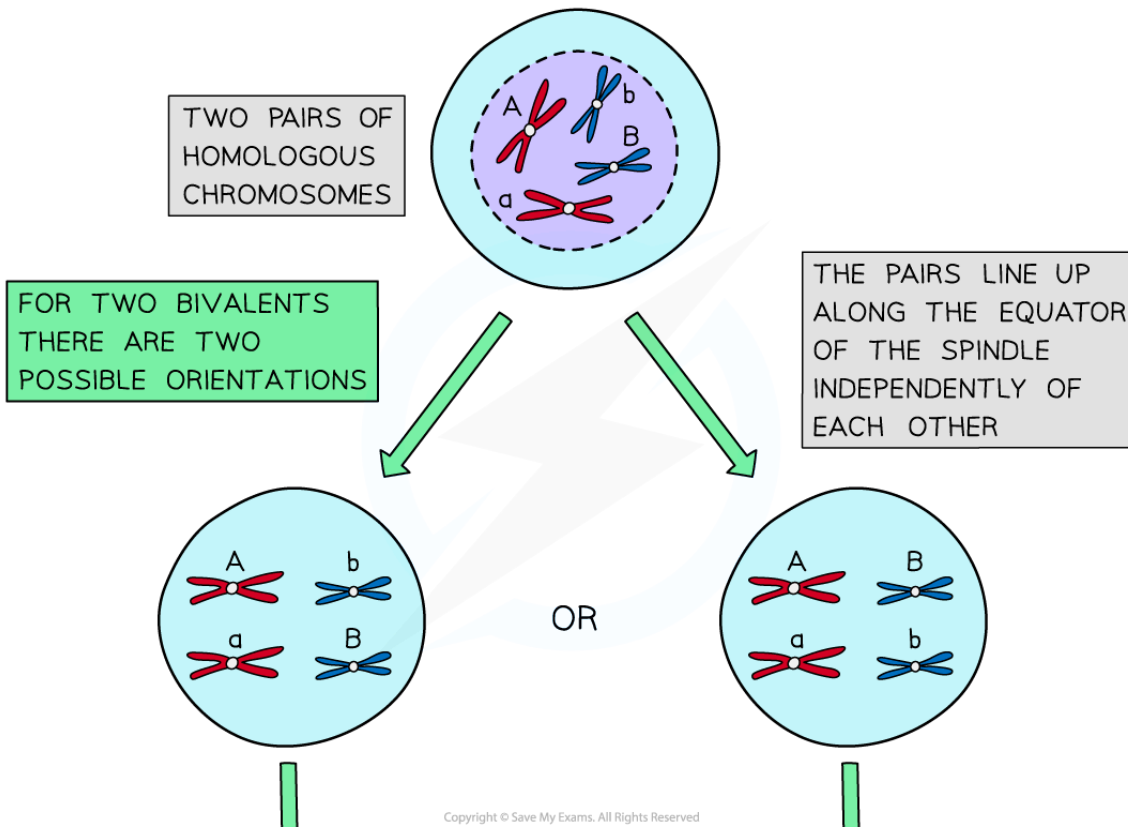



Your notes

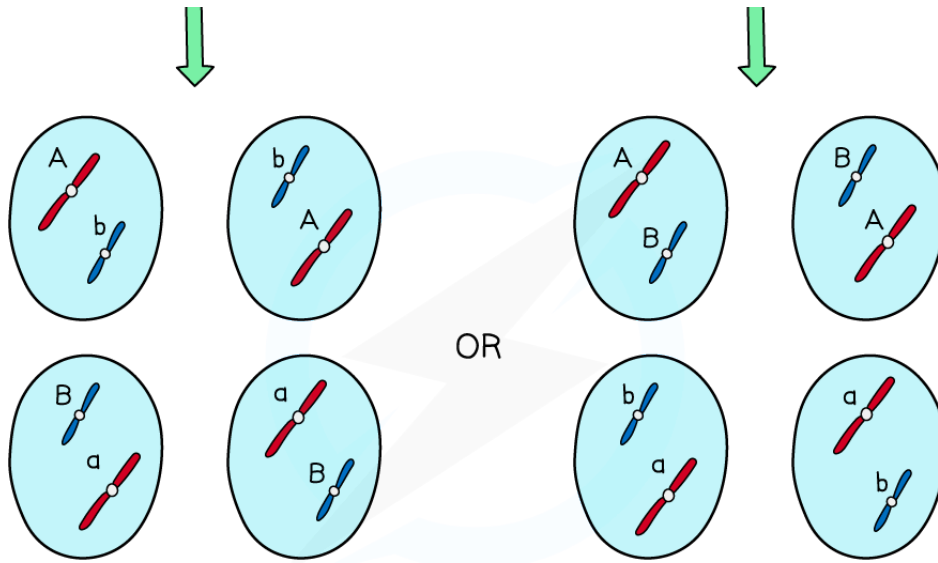

AT THE END OF MEIOSIS II, EACH ORIENTATION GIVES TWO TYPES OF GAMETE. THERE ARE THEREFORE FOUR TYPES OF GAMETE ALTOGETHER

Copyright © Save My Exams. All Rights Reserved

Independent assortment of homologous chromosomes leading to different genetic combinations in daughter cells



Your notes

Explaining Deviations from Mendelian Ratios

NOS: Careful observation and record keeping turned up anomalous data that Mendel's law of independent assortment could not account for

- Gregor Mendel (of pea plant fame) devised the **law of independent assortment** in 1866
- In this, he states that characteristics are inherited **completely independently** of others
- This was refined by later scientists to state that the allele that gets sorted into a particular gamete cell is **not influenced** by the allele received for another gene
- In many cases, this holds true, and can be observed in **Mendelian ratios** of offspring in certain crossing experiments
 - Mendel observed a 9:3:3:1 ratio in many dihybrid crosses of sweet pea plants
- As a result, **Mendel's findings were not challenged** until the early 20th century, when Bateson and Punnett found **seemingly anomalous** ratios of offspring
- For which they could offer no explanation
- These became named as **non-Mendelian ratios** because they did not follow the pattern as predicted by Mendel

Bateson and Punnetts' experiment (1905)

- Also working with sweet peas, **two pairs of alleles** were identified (Dominant alleles in capital letters)
 - Flower colour:
 - P** = purple, **p** = red
 - The shape of pollen grains:
 - R** = long, **r** = round
- Their first cross involved pure-bred purple-flowered plants with long pollen grains (**PPRR**) with pure-bred red-flowered plants with round pollen grains (**pprr**)
- As expected, this cross resulted in 100% purple-flowered plants with long pollen grains, with the double-heterozygous genotype **PpRr** in the F₁ generation
- However, when individuals from the F₁ generation were crossed with each other, Bateson and Punnett **would have expected a 9:3:3:1 mix of phenotypes**, in line with Mendel's law of independent assortment

Modelling the expected ratios using a Punnett square

Parental phenotypes:	purple flowers, long pollen grains	x	purple flowers, long pollen grains
Parental genotypes:	PpRr	x	PpRr
Parental gametes:	PR or Pr or pR or pr	x	PR or Pr or pR or pr

Dihybrid Cross Punnett Square Table



Your notes

		PARENT 1			
		PR	P _r	pR	p _r
PARENT 2	PR	PPRR	PPR _r	PpRR	PpR _r
	P _r	PPR _r	PP _{rr}	PpR _r	Pp _{rr}
	pR	PpRR	PpR _r	ppRR	ppR _r
	p _r	PpR _r	Pp _{rr}	ppR _r	pp _{rr}

Copyright © Save My Exams. All Rights Reserved

- Expected phenotype ratios for the second generation:
 - 9 purple flowers, long pollen grains
 - 3 purple flowers, round pollen grains
 - 3 red flowers, long pollen grains
 - 1 red flowers, round pollen grains

Actual Results from Bateson and Punnett's Experiment

- In the F₂ generation of offspring, there were...
 - Very many** of the grandparent phenotype (purple-flowered, long pollen grains) produced
 - Many** of the grandparent phenotype (red-flowered, round pollen grains) produced
 - Very few (but not zero)** other phenotypes (purple/round or red/long) produced
- This **appeared as an anomaly** to Bateson and Punnett, though they did not find an explanation

Thomas Hunt Morgan developed the notion of linked genes to account for the anomalies

- Later in the 20th century (approx. 1910–1940), an American biologist, **Thomas Hunt Morgan**, put forward an explanation for the results previously observed by Bateson and Punnett
- From his findings, he devised the theory of linkage
- Morgan worked on **fruit flies** (*Drosophila melanogaster*) thanks to their ability to reproduce **quickly**, in **large numbers**, in a small physical space and with **observable heritable characteristics** like eye colour and wing shape
- In fact, Morgan bred them selectively for many years to develop a range of phenotypes by natural mutation
- Morgan's work identified sex-linked characteristics from genes carried on the X or Y chromosomes that determine gender
- This work led Morgan to develop the idea of autosomal linkage
- This is where **unexpected patterns of inheritance** are caused by separate alleles being inherited **together**, from the same chromosome (an autosome)

- Morgan then elaborated his work by developing the theory of **crossing over**
 - As a way of accounting for unexpected (recombinant) genotypes

Examiner Tip

Several sources of genetic variation have been outlined above. It is also worth remembering that genetic variation can occur on an even smaller scale than chromosomes. Mutations can occur within genes. A random mutation that takes place during DNA replication can lead to the production of new alleles and increased genetic variation.



Your notes



Your notes

10.1.4 Meiosis II

Meiosis II

Second division of Meiosis : Meiosis II

- There is **no interphase between meiosis I and meiosis II** so the DNA is not replicated
- The second division of meiosis is almost identical to the stages of mitosis
- Prophase II
 - The **nuclear envelope breaks down** and **chromosomes condense**
 - A **spindle forms at a right angle to the old one**
- Metaphase II
 - **Chromosomes** line up in a **single file along the equator** of the spindle
- Anaphase II
 - Centromeres divide and individual **chromatids are pulled to opposite poles**
 - Sister chromatids separate in meiosis (anaphase) II
 - However, they are likely to be **non-identical sister chromatids** at this stage due to crossing over having happened in prophase I
 - This creates **four groups of chromosomes** that have half the number of chromosomes compared to the original parent cell
- Telophase II
 - **Nuclear membranes form** around each group of chromosomes
- Cytokinesis
 - **Cytoplasm divides** as new cell surface membranes are formed **creating four haploid cells**

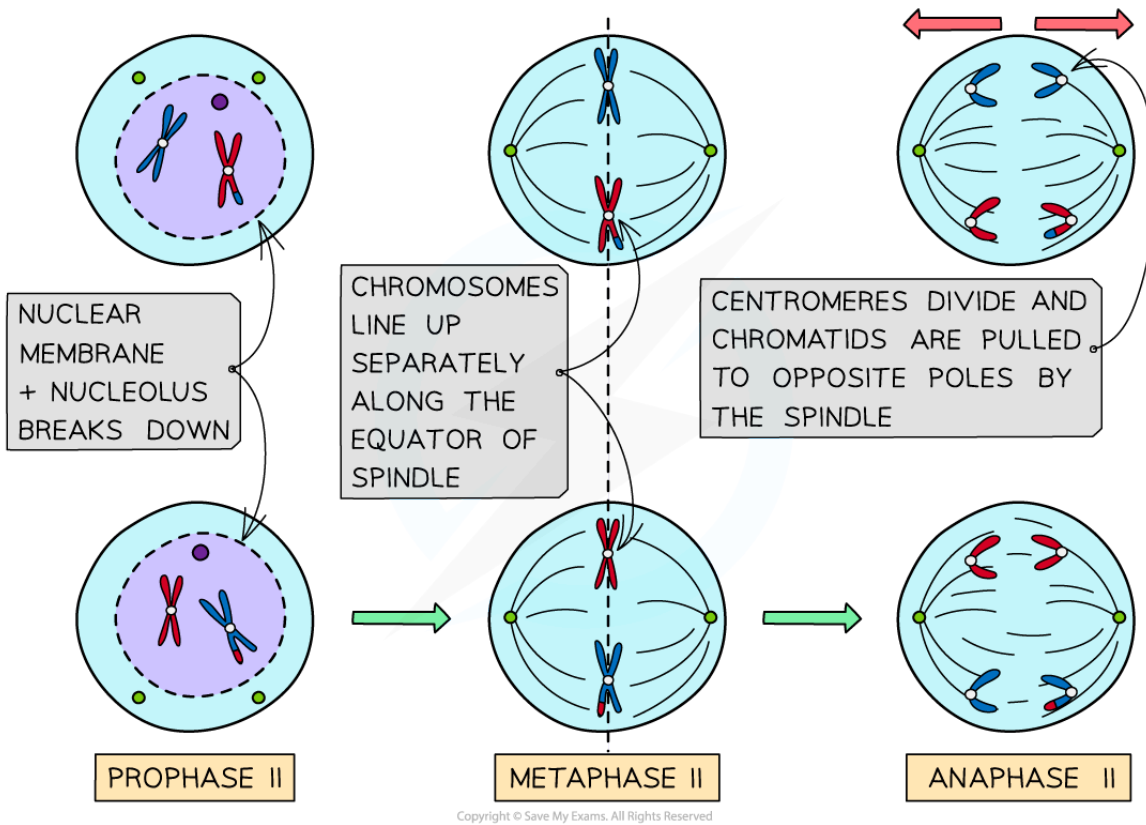

Prophase II, Metaphase II and Anaphase II in Meiosis II of an animal cell



Your notes

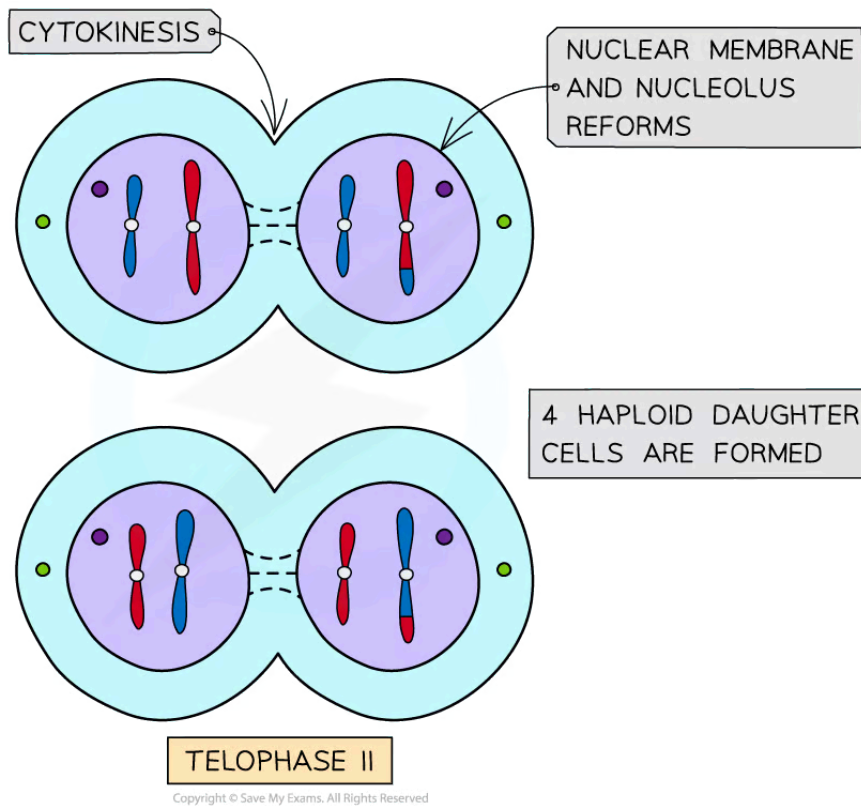

Telophase II and cytokinesis in Meiosis II of an animal cell

 **Examiner Tip**

Because of the many similarities between mitosis and meiosis II, you are more likely to get a detailed question on meiosis I than meiosis II and the sources of variation that occur in meiosis I. Revise them both though!



Your notes

10.1.5 Skills: Drawing Chiasmata

Drawing Chiasmata

Skill: Drawing diagrams to show chiasmata formed by crossing over

Drawing tips

- Use two coloured pens/pencils to show chromosomes/chromatids of maternal or paternal origin
 - One chromosome of each colour makes a homologous pair
 - Blue and red are conventionally used for this purpose, but any colour choices that show good contrast are acceptable
 - Draw each homologous chromatid as a long line

Stage 1: Synapsis

- All 4 chromatids of a pair of homologous chromosomes align closely together
- Draw this as 4 lines in close proximity, 2 red and 2 blue
 - Remember to include the centromeres

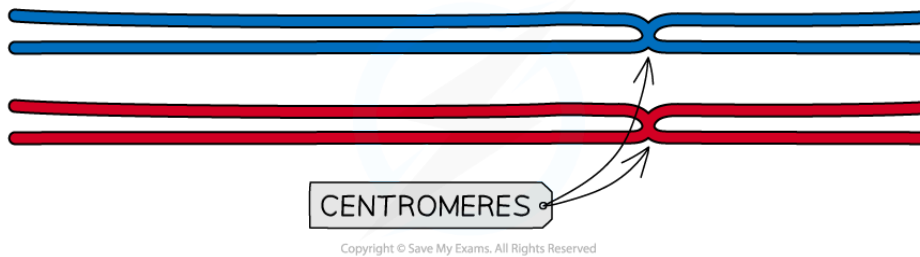

Stage 1: Synapsis. A bivalent (tetrad) forms from two homologous chromosomes. There are 4 chromatids aligned against each other

Stage 2: Cuts occur in the DNA of non-sister chromatids

- During **coiling and shortening of DNA** in prophase I, the DNA is stressed/placed under tension
- This causes a **cut in the DNA** of one of the chromatids, catalysed by **endonuclease** enzymes
 - In fact, **many cuts occur simultaneously** within the same bivalent
- One such cut is shown below
- The adjacent non-sister chromatid also breaks **at the same point** as it has the same base sequence at the point of breakage
 - And is cut by the same endonuclease enzyme



Your notes

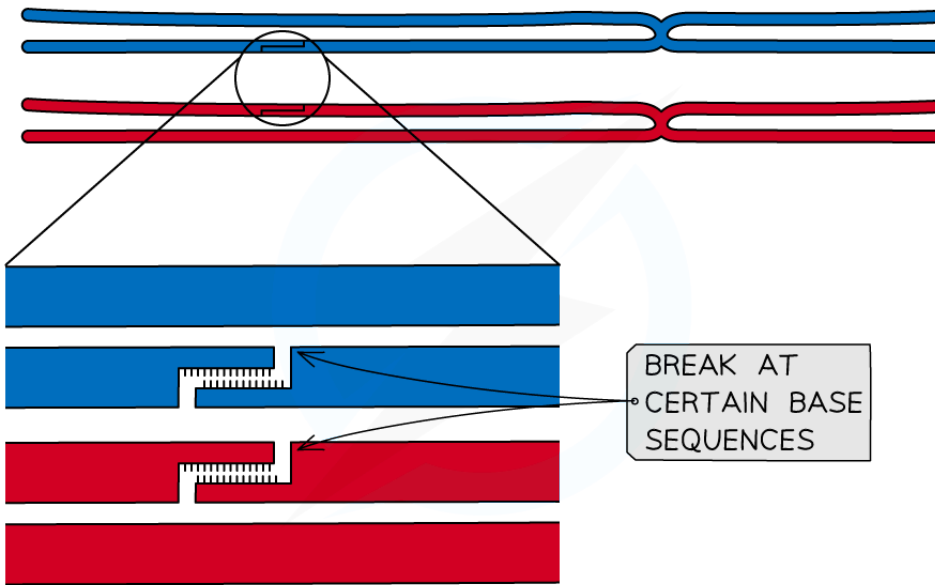

Copyright © Save My Exams. All Rights Reserved

Stage 2: Cuts occur in the DNA of non-sister chromatids

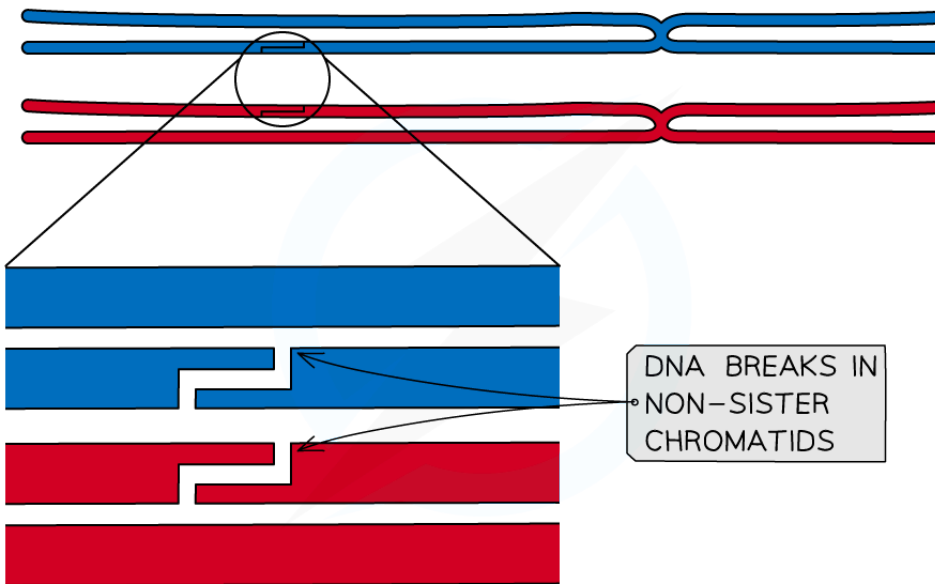

Copyright © Save My Exams. All Rights Reserved

Stage 2: Cuts occur in the DNA of non-sister chromatids

Stage 3: Formation of Chiasmata

- There are **loose, cut ends of DNA** within the bivalent with short sections of exposed, unpaired bases
- These bases **re-form hydrogen bonds** to complementary bases quickly, however,



Your notes

- They can base-pair to cut ends from a **different chromatid**
- This can occur with a non-sister chromatid because the non-sister chromatid will have a very similar, **almost identical sequence of bases**
- This is how crossing-over leads to **swapping of alleles** between non-sister chromatids
- When the chromosomes condense and shorten again, the chiasmata continue to hold non-sister chromatids together
- This causes the overall chromosome shape to feature **X-shapes** at the chiasmata, viewable under an **electron microscope**

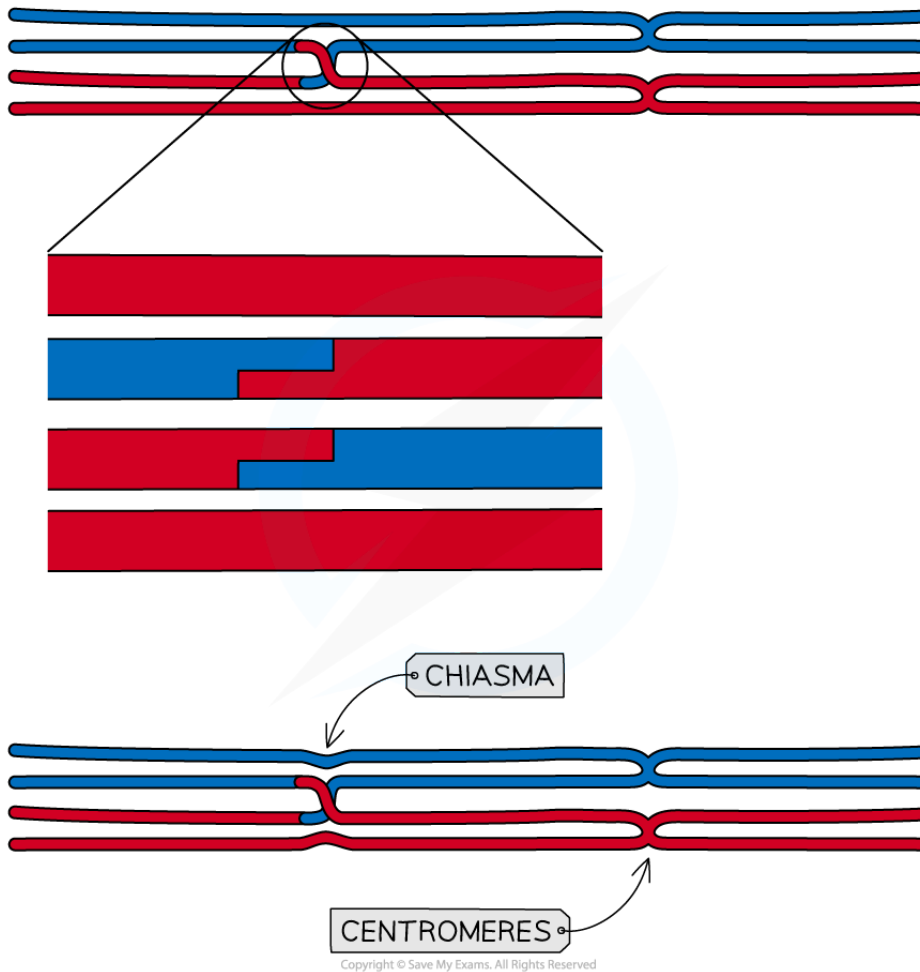

Stage 3: Appearance of the recombinant bivalent, with chiasma showing as an X-shape



Your notes

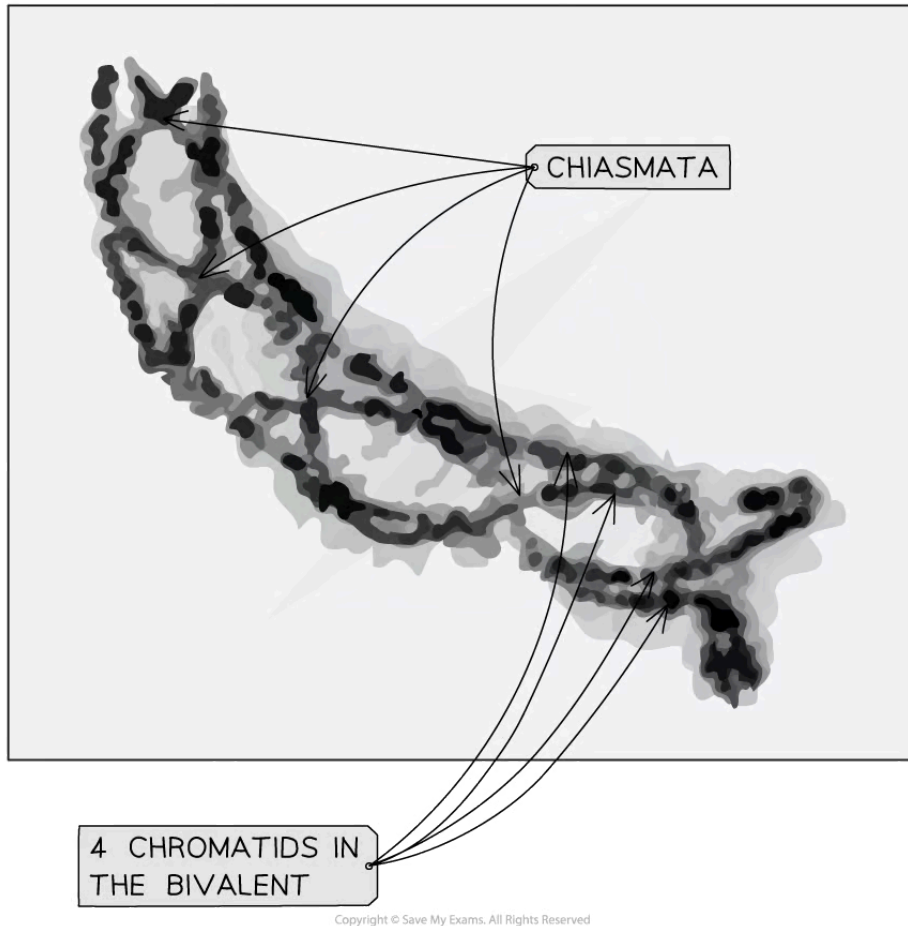

Electron micrograph of a bivalent in prophase 1, showing multiple chiasmata