



# HL IB Physics



## Current & Circuits

### Contents

- \* Circuit Diagrams
- \* Electric Current
- \* Electric Potential Difference
- \* Electrical Conductors & Insulators
- \* Electric Resistance
- \* Electrical Resistivity
- \* I-V Characteristics
- \* Series & Parallel Circuits
- \* Electrical Power
- \* Sources of Electrical Energy
- \* Electromotive Force & Internal Resistance
- \* Variable Resistance



Your notes

## Circuit Diagrams

### Circuit Diagrams

- Circuit symbols are used to represent electrical components in circuit diagrams
- These symbols are universally recognised by all scientists in any language
- The following symbols are commonly used in circuit diagrams

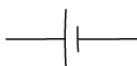

CELL

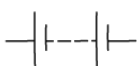

BATTERY



SWITCH



VOLTMETER



AMMETER



RESISTOR



VARIABLE RESISTOR

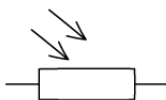

LIGHT-DEPENDENT RESISTOR (LDR)



THERMISTOR

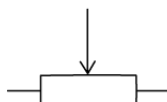

POTENTIOMETER



LAMP



LIGHT EMITTING DIODE (LED)



HEATING ELEMENT



MOTOR



EARTH (GROUND)

Copyright © Save My Exams. All Rights Reserved

#### Circuit symbols

### Cells & Batteries



Your notes

- A device which converts energy from a chemical energy store to electrical store (one battery)
  - The direction of the current flow is from the **positive** (longer side) to the **negative** (shorter side) terminal
  - This is the opposite direction to the electron flow

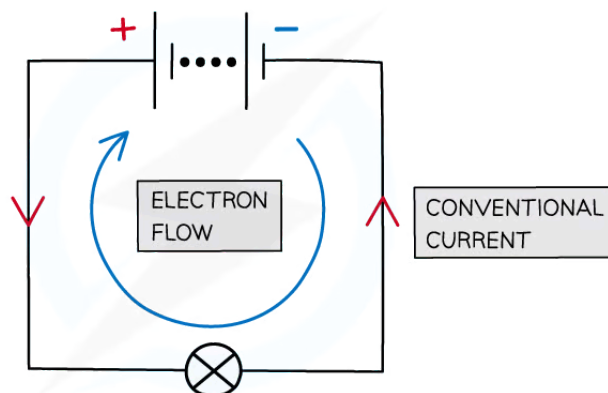

Copyright © Save My Exams. All Rights Reserved

- A **battery** is simply a power source made up of multiple cells

## Switch

- A device which turns the circuit on (closed), or off (open)
- The switch allows or prevents the flow of current

## Voltmeters & Ammeters

- A **voltmeter** is a device which measures the potential difference between two points in a circuit
- An **ammeter** is a device which measures the current flowing in a circuit

## Fixed resistor

- A device which increases resistance to limit the flow of current
- As electrons flow through a resistor, they transform energy from its electric potential energy store into other stores (e.g. thermal energy)

## Variable resistor

- A resistor with a slider that can be used to **change its resistance**
- As the resistance of the variable resistor increases, the current in the circuit decreases and vice versa

## Light-dependent resistor (LDR):

- A resistor whose resistance depends on the light intensity
- As light intensity increases, the resistance of an LDR decreases and vice versa

## Thermistor:

- A resistor whose resistance depends on its temperature
- As temperature increases, the resistance of a thermistor decreases and vice versa

## Potentiometer

- A resistor with a sliding contact to form an adjustable voltage divider



Your notes

## Lamp

- A lighter emitting component consisting of heating a filament inside a glass cover

## Light-emitting diode (LED)

- A device that emits light when a current passes through it
- A diode only allows current to flow in one direction only

## Heating element

- An element that converts energy from an electrical store into a thermal store through the process of resistance

## Motor

- An element that converts energy from an electrical store into a mechanical store

## Earth (ground)

- The point in the circuit which is grounded i.e. connected to the Earth
- A connection to the Earth allows an instantaneous discharge to occur if an appliance malfunctions
- Electrons are transferred directly to the Earth through a low-resistance wire

## Drawing Circuit Diagrams

- Circuit **diagrams** represent the **arrangement** of components in a circuit
  - This is important, as some components need to be in a certain position in relation to the others to work
- Being able to draw and interpret circuit diagrams using circuit symbols is an essential skill in the electricity topic

## A circuit diagram must include:

- An **energy source**
  - This is a source of **potential difference** so a current can flow
  - This can be a cell, battery, or a power supply
- A **closed path** or a **complete circuit**
  - Electrons need to flow in a complete loop for a current to flow
  - A circuit can be open and closed using a switch
- **Electrical components** (using the correct circuit symbol)
  - These could act as sensors that respond to the environment (LDR, thermistor)
  - Or, measure a value (ammeter, voltmeter)
  - Or, transfer electrical energy to other forms of energy (LED, lamp)

## Measuring Current

- Electric current is measured using an **ammeter**
- Ammeters should always be connected in **series** within a circuit

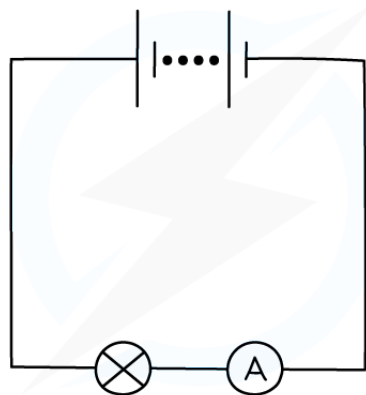

Copyright © Save My Exams. All Rights Reserved

**To measure the current flowing through a light bulb, an ammeter must be connected in series with it**

- An **ideal** ammeter should have zero resistance
  - This way, it will not take any energy from the electrons flowing through it
  - Otherwise, it would alter the value of the current it is trying to measure

### Measuring Potential Difference

- Potential difference (or voltage) is measured using a **voltmeter**
- A voltmeter is always set up **in parallel** to the component being measured
- This means that the voltmeter must be connected across the terminals of the component

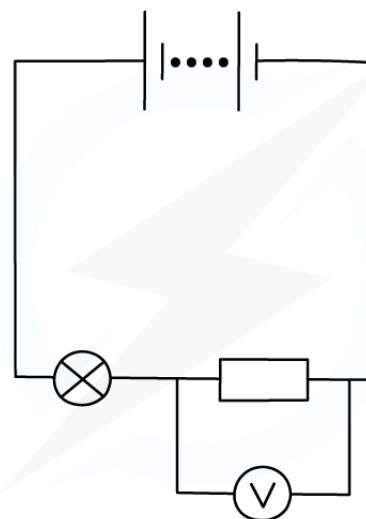

Copyright © Save My Exams. All Rights Reserved

**To measure the potential difference of a fixed resistor, a voltmeter must be connected in parallel to it**

- A measurement of potential difference represents the difference between the values of electric potential on either side of the component

- This is because 1 Volt (V) is equivalent to 1 Joule per Coulomb ( $\text{J C}^{-1}$ )
- Therefore, the key rules to remember are:
  - An ammeter is always connected in **series**
  - A voltmeter is always connected in **parallel** to the component the voltage is being measured
  - The direction of current flow is always from the **positive** to the **negative** terminal of the power supply



Your notes

### Examiner Tip

The standard circuit symbols are given in the data booklet, so you do not need to memorise them. However, you must be able to identify them and draw them correctly.

When asked to draw a circuit diagram, make sure to draw the wires as straight lines with a straight edge or a ruler and make it as neat as possible, especially the circuit symbols.

If the diagram is too small or there is ambiguity as to what a symbol represents, the examiner may not award you full marks!



Your notes

## Electric Current

### Electric Current

- Electric current is **the rate of flow of charge** carriers and is measured in units of **amperes (A)** or **amps**
- Charge can be either **positive** or **negative** and is measured in units **coulombs (C)**
- When two oppositely charged conductors are connected together (by a length of wire)
  - The charge will flow between the two conductors, giving rise to a current
  - The greater the flow of charge, the greater the electric current

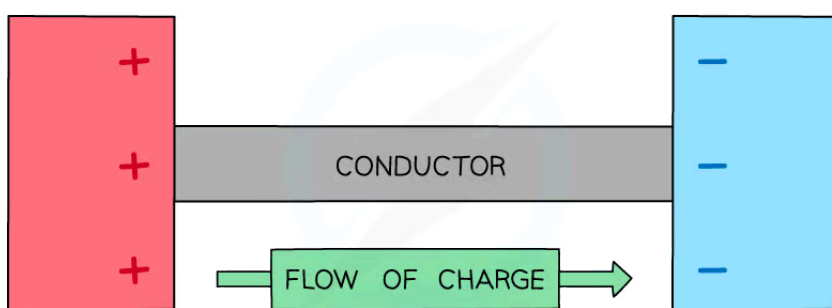

Copyright © Save My Exams. All Rights Reserved

**Charge can flow between two conductors. The direction of conventional current in metal is from positive to negative**

- In electrical wires, the current is a flow of **electrons**
- Electrons are **negatively** charged so they flow **away** from the negative terminal of a cell **towards** the positive terminal
- **Conventional current** is defined as the flow of positive charge from the **positive** terminal of a cell to the **negative** terminal
  - This is the **opposite** of the direction of electron flow, as the conventional current was described before the electric current was really understood



Your notes

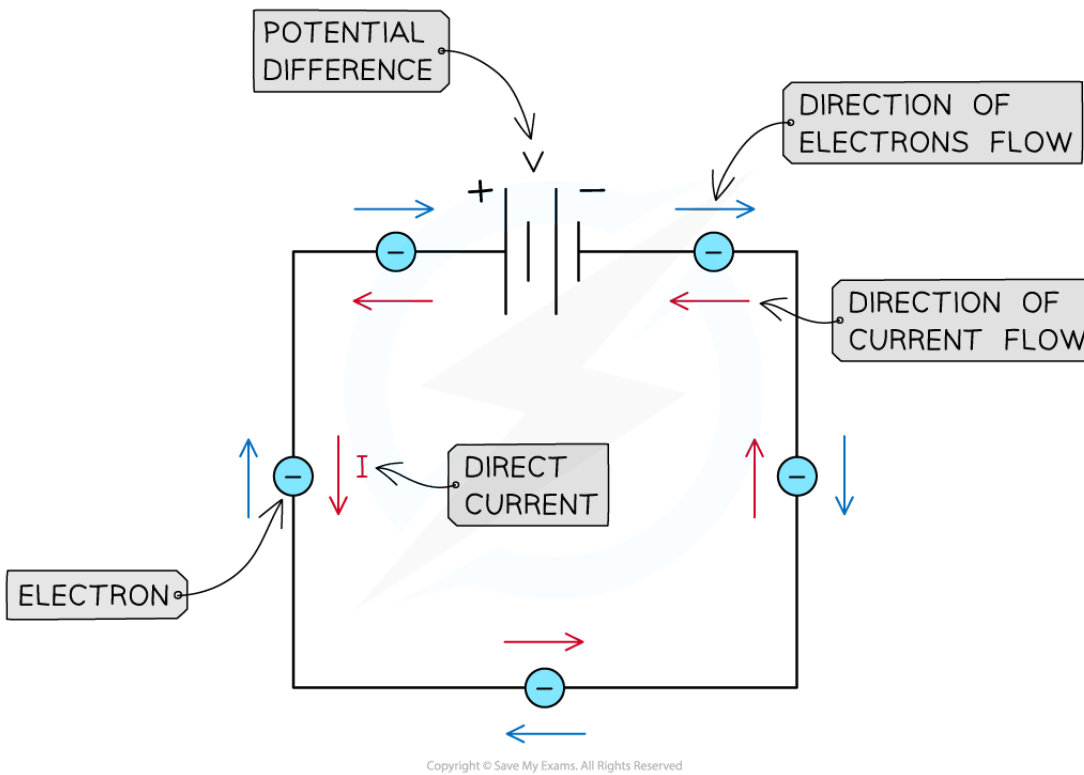

**Direct current flows from the positive to the negative terminal of the battery in a circuit. Electrons flow in the opposite direction**

- The **potential difference** in the circuit causes the current to flow
- Current is measured using an **ammeter**

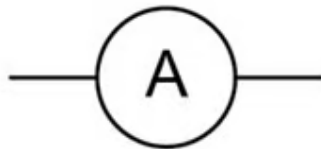

- **Direct current (dc)** flows through the circuit in **one direction**
  - The direction of conventional current is from the **positive** terminal to the **negative** one
  - This is **opposite** to the **electrons** flow
- Direct current is produced when from cells and batteries



DIRECT CURRENT (D.C.)

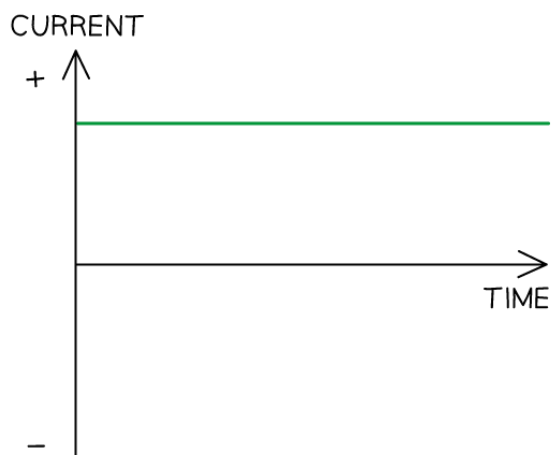

**Direct current is current that only flows in one direction and has one value**

- The equation for current is:

$$I = \frac{\Delta q}{\Delta t}$$

- Where:
  - $I$  = current (A)
  - $\Delta q$  = change in charge (C)
  - $\Delta t$  = time interval (s)



Your notes

### Worked example

When will 8 mA of current pass through an electrical circuit?

- A. When 1 J of energy is used by 1 C of charge
- B. When a charge of 4 C passes in 500 s
- C. When a charge of 8 C passes in 100 s
- D. When a charge of 1 C passes in 8 s

**Answer: B**

- The equation relating current, charge and time is:

$$I = \frac{\Delta q}{\Delta t}$$

- Consider option **B**:

$$I = \frac{4}{500} = 8 \times 10^{-3} = 8 \text{ mA}$$

- Therefore, the correct answer is **B**
- **A** is incorrect as it does not contain a value for charge or time, so it can be ruled out
- **C** is incorrect as:

$$I = \frac{8}{100} = 80 \times 10^{-3} = 80 \text{ mA}$$

- **D** is incorrect as:

$$I = \frac{1}{8} = 125 \times 10^{-3} = 125 \text{ mA}$$

### Examiner Tip

Remember that conventional current flow is always from the **positive** to the **negative** terminal. This is important in understanding circuits and whether components such as an LED, which only works if the diode points in the direction of conventional current flow.

Current can be positive or negative. It is still a scalar quantity, but the sign just indicates its **direction**. Direct current (dc) will only ever be in one direction.



Your notes

## Electric Potential Difference

### Electric Potential Difference

- Potential difference (p.d.) is a measure of the electrical **potential energy** transferred by electrons as they move between two points in a conductor
- The definition of potential difference, also known as voltage, is:  
**The work done per unit charge on moving a positive charge between two points along the path of the current**
- Potential difference is measured in volts (V) and is calculated as follows:

$$V = \frac{W}{q}$$

- Where:
  - $V$  = potential difference (V)
  - $W$  = work done (J)
  - $q$  = charge (C)
- From the above equation, one volt is equal to one joule per unit coulomb
  - $1\text{V} = 1\text{J C}^{-1}$
- The potential difference in a d.c. circuit is provided by **cells** or **batteries**
  - Each cell has a **positive terminal** (high potential location) and a **negative terminal** (low potential location)
  - A battery is a collection of cells arranged positive terminal to negative terminal

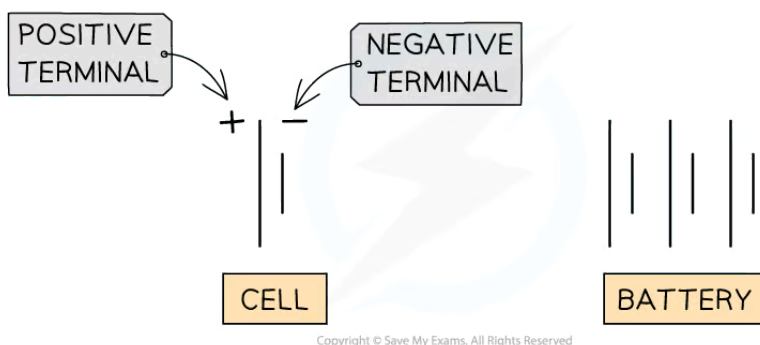

**A cell and a battery made of three cells**

- When both terminals of a cell, or battery, are connected to a loop of conducting wire, a **circuit** is formed
- The cell or battery is the **source** of the potential difference needed for the electrons to flow
- Electrons gain electrical potential energy as they move through the cell

- A small amount of their energy is transferred to the metal ions in the wire
- The flow of electrons is from the negative to the positive terminal



Your notes

## The Electronvolt

- The energy values associated to electrons and other microscopic particles are very small when expressed in SI units
- For this reason, it is often more convenient to use another unit for energy - the **electronvolt (eV)**
- The electronvolt is defined as follows:  
**The amount of energy needed to move an electron through a potential difference of one volt**

### Worked example

Determine the value of 1 eV in joules (J).

**Answer:**

#### Step 1: Recall the definition of electronvolt

- One electronvolt is the work  $W$  associated with an electron of charge  $e$  moving through a potential difference  $V = 1\text{V}$

$$W = qV = eV$$

- Where  $e$  is the charge of an electron =  $1.6 \times 10^{-19}\text{ C}$

#### Step 2: Substitute this and the value of the voltage into the above equation for $W$

$$W = (1.6 \times 10^{-19}\text{ C}) \times 1\text{V}$$

$$W = 1.6 \times 10^{-19}\text{ J}$$

- One electronvolt is equal to  $1.6 \times 10^{-19}$  joules

### Examiner Tip

The value for the charge of an electron is given on your data sheet.

The units of electronvolt (eV) will appear in future topics such as a in Spectra & Atomic Energy Levels



Your notes

## Electrical Conductors & Insulators

### Electrical Conductors & Insulators

#### Conductors

- A **conductor** is a material that allows **charge** (usually electrons) to flow through it easily
- Examples of conductors are:
  - Silver
  - Copper
  - Aluminium
  - Steel
- Conductors tend to be **metals**

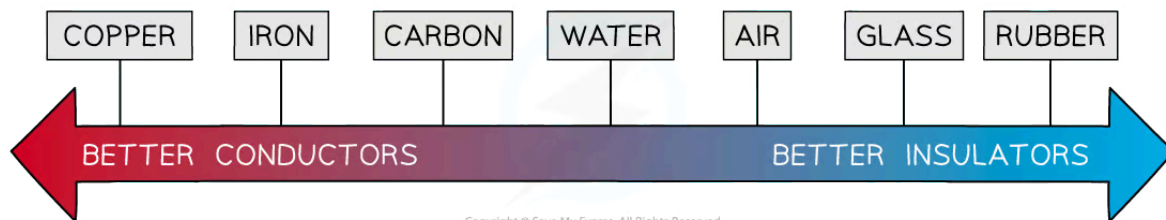

Copyright © Save My Exams. All Rights Reserved

***Different materials have different properties of conductivity***

- On the atomic scale, conductors are made up of positively charged metal ions within a sea of delocalised electrons
- Metals are **excellent conductors** of electricity because:
  - Current is the rate of flow of electrons
  - So, the more easily electrons are able to flow in a material, the **better** it is at conducting electricity



Your notes

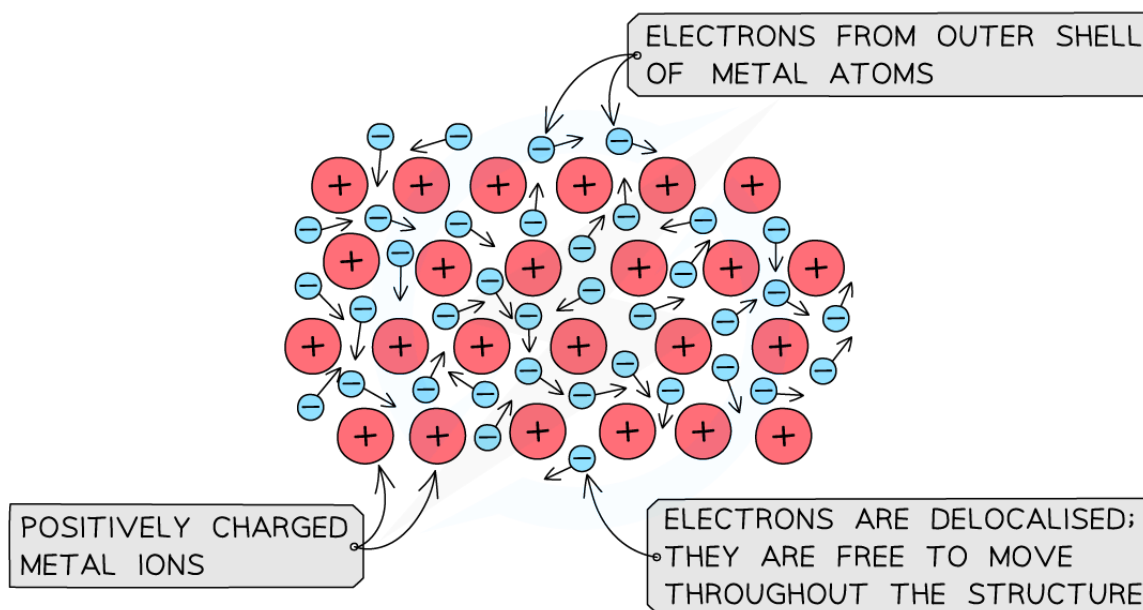

Copyright © Save My Exams. All Rights Reserved

*The lattice structure of a conductor with positive metal ions and delocalised electrons*

## Insulators

- An **insulator** is a material that has **no free charges**, hence does **not** allow the flow of charge through them very easily
- Examples of insulators are:
  - Rubber
  - Plastic
  - Glass
  - Wood
- Some non-metals, such as wood, allow some charge to pass through them
- Despite not being very good at producing an electrical current, insulators are able to conduct **static electricity**
  - This occurs when an insulator builds up charge on its surface
  - When a charged insulator comes into contact with a conductor, the charge can be transferred



Your notes

## Electric Resistance

### Electric Resistance

- As electrons move through a conductor within a circuit (or any other component), they collide with the metal ions and transfer some of their electrical **potential energy** to the **positive ions** of the metal

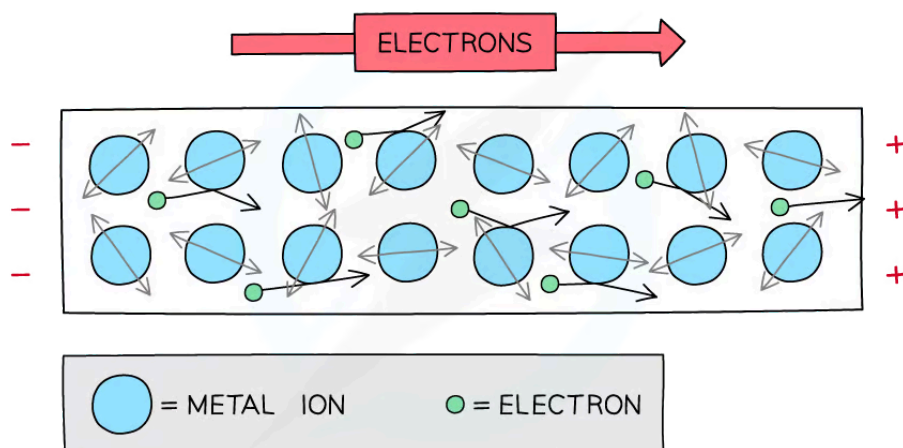

**Free electrons collide with metal ions which resist their flow**

- This transfer of energy results in an increase in the kinetic energy of the atoms in the lattice
  - This raises the overall internal energy of the metal
- The macroscopic result of this transfer is the **heating up** of the wire which causes **resistance**
- Some metals heat up more than others
  - The greater the **heating effect**, the higher the **resistance**
  - Copper has a **low** electrical resistance, making it an ideal material to make wires from
- All electrical components have resistance to different degrees, including the wires and batteries
- Voltmeters and ammeters are said to be **ideal** when
  - An ideal voltmeter has **infinite** resistance, such that **no** current passes through it
  - An ideal ammeter has **zero** resistance, such that **all** the current passes through it

#### Examiner Tip

Unless otherwise stated, voltmeters and ammeters will always be **ideal** in exam questions. This simply means you do not need to consider the resistance of an ammeter or voltmeter as part of the total resistance of the circuit

When non-ideal meters are used, the resistance will always be **constant**

## Calculating Resistance

- The resistance **R** of a component is defined as:

**The ratio of the potential difference across the component to the current flowing through it**

- It is calculated as follows:

$$R = \frac{V}{I}$$

- Where:
  - $V$  = potential difference (V)
  - $I$  = electric current (A)
  - $R$  = resistance ( $\Omega$ )
- The units for resistance is **ohms** represented by the greek letter 'omega',  $\Omega$
- The **higher** the resistance of a component, the **lower** the current flowing through it and vice versa
- In terms of SI base units:  $1\Omega = 1\text{ kg m}^2\text{ s}^{-3}\text{ A}^{-2}$



Your notes





Your notes

### Worked example

A charge of 5.0 C passes through a resistor at a constant rate in 30 s. The potential difference across the resistor is 2.0 V.

Calculate the resistance  $R$  of the resistor.

**Answer:**

#### Step 1: Write down the known quantities

- Charge,  $\Delta q = 5.0$  C
- Time,  $\Delta t = 30$  s
- Potential difference,  $V = 2.0$  V

#### Step 2: Write down the equation for the resistance $R$

$$R = \frac{V}{I}$$

#### Step 3: Calculate the current $I$ from the charge and time

$$I = \frac{\Delta q}{\Delta t}$$

#### Step 4: Substitute the numbers into the above equation

$$I = \frac{5.0}{30} = 0.17 \text{ A}$$

#### Step 5: Substitute this value of the current into the equation for the resistance given in Step 2

$$R = \frac{2.0}{0.17} = 12 \Omega$$

### Examiner Tip

It is common for current to be given in mA or potential difference in kV. For resistance to be in  $\Omega$ , you must convert mA into A and kV into V!



Your notes

## Electrical Resistivity

### Electrical Resistivity

- The **resistance** of a sample depends on:
  - The material it is made of
  - The length of the sample
  - The cross-sectional area of the sample
- The resistance of a conductor (e.g. a wire) is:
  - **Directly proportional** to its **length**
  - **Inversely proportional** to its **cross-sectional area**

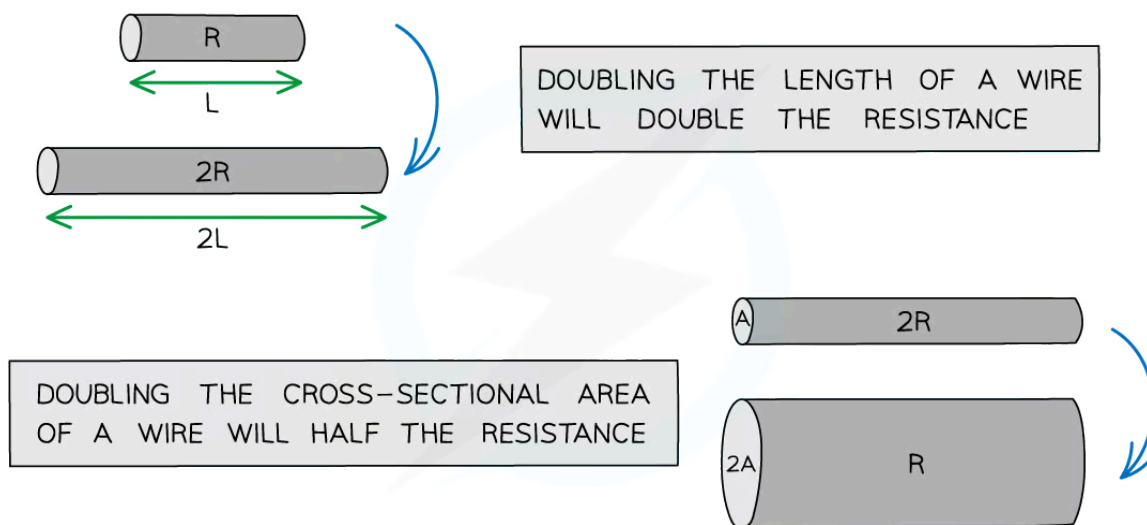

Copyright © Save My Exams. All Rights Reserved

#### *How the dimensions of a wire (i.e. length and width) affect its resistance*

- The cross-sectional area of a **wire** is always modelled as a **circle**
  - Therefore, the cross-sectional area is  $\pi r^2$ , where  $r$  is the radius of the wire

### Resistivity

- This leads to the definition of a new quantity, called **resistivity**
- Resistivity is a property describing the extent to which a material **opposes** the flow of electric current through it
- It is defined as follows:
 

**The resistivity of a material is equal to the resistance per unit length of a material with unit cross-sectional area**
- The equation for the resistivity is:

$$\rho = \frac{RA}{L}$$

- Where:
  - $\rho$  = resistivity in ohm-metres ( $\Omega \text{ m}$ )
  - $R$  = resistance in ohms ( $\Omega$ )
  - $A$  = cross-sectional area of material in square metres ( $\text{m}^2$ )
  - $L$  = length of material in metres (m)
- Resistivity is measured in ohm-metres ( $\Omega \text{ m}$ )
- Resistivity is the **property** of a material

**Resistivity of Materials Table**

	Material	Resistivity $\rho / \Omega \text{ m}$
<b>Metals</b>	Copper	$1.7 \times 10^{-8}$
	Gold	$2.4 \times 10^{-8}$
	Aluminium	$2.6 \times 10^{-8}$
<b>Insulators</b>	Glass	$10^{12}$
	Sulfur	$10^{15}$

Copyright © Save My Exams. All Rights Reserved

- Conductors, such as metals, have **low** values of resistivity
  - This makes metals, such as copper and aluminium, ideal for making wires as they have low values of resistance, which is why they are excellent conductors
- Whereas insulators have such **high** values of resistivity that virtually no current will flow through them
  - This is why insulating materials, such as plastic and rubber, are ideal for housing electrical wires, as they keep current flowing within the circuit and prevent users from receiving dangerous electric shocks



Your notes

### Worked example

Two conducting cylinders are made from copper and aluminium respectively. The dimensions of the cylinders are shown in the diagram below.

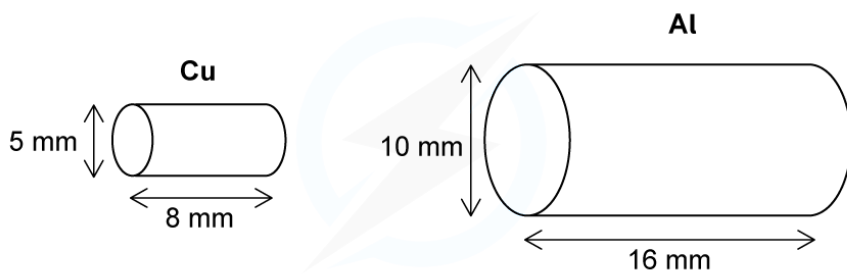

Copyright © Save My Exams. All Rights Reserved

- Resistivity of copper =  $1.7 \times 10^{-8} \Omega \text{ m}$
- Resistivity of aluminium =  $2.6 \times 10^{-8} \Omega \text{ m}$

Determine which cylinder is a better conductor.

**Answer:**



Your notes

STEP 1 THE BETTER CONDUCTOR WILL HAVE LOWER RESISTANCE

STEP 2 RESISTANCE IS CALCULATED FROM

$$R = \frac{\rho L}{A}$$

STEP 3 RESISTANCE OF THE COPPER CYLINDER

THE CROSS-SECTIONAL AREA OF A CYLINDER IS A CIRCLE

$$A = \pi r^2 = \pi \left(\frac{d}{2}\right)^2 = \pi \times \left(\frac{5 \times 10^{-3}}{2}\right)^2 = 2.0 \times 10^{-5} \text{ m}^2$$

mm → m

$$R = \frac{1.7 \times 10^{-8} \times 8 \times 10^{-3}}{2.0 \times 10^{-5} \text{ m}^2} = 6.8 \times 10^{-6} \Omega$$

SUBSTITUTE VALUES INTO THE EQUATION

STEP 4 RESISTANCE OF THE ALUMINIUM CYLINDER

$$A = \pi r^2 = \pi \left(\frac{d}{2}\right)^2 = \pi \times \left(\frac{10 \times 10^{-3}}{2}\right)^2 = 7.9 \times 10^{-5} \text{ m}^2$$

$$R = \frac{2.6 \times 10^{-8} \times 16 \times 10^{-3}}{7.9 \times 10^{-5} \text{ m}^2} = 5.3 \times 10^{-6} \Omega$$

STEP 5 RESISTANCE OF ALUMINIUM CYLINDER < RESISTANCE OF COPPER CYLINDER  
THE ALUMINIUM CYLINDER IS THE BETTER CONDUCTOR

Copyright © Save My Exams. All Rights Reserved

### Examiner Tip

You won't need to memorise the value of the resistivity of any material, these will be given in the exam question. The equation for resistivity is also given in the data booklet.

The area of a circle equation is given on your data booklet as  $A = \pi r^2$ . In terms of diameter, this is

$$A = \pi \left(\frac{d}{2}\right)^2 = \frac{\pi d^2}{4}$$

Remember, if the cross-sectional area of the shape is a circle (e.g. in a wire), it is proportional to the diameter or radius **squared**. This means if the diameter (or radius) doubles, the area quadruples causing the resistance to drop by a **quarter**.



Your notes

## I-V Characteristics

### Ohm's Law

- Ohm's law states that:

**For a component at a constant temperature, the current through it is proportional to the potential difference across it**

- It is defined by the equation:

$$V = IR$$

- Where:

- $V$  = potential difference (V)
- $I$  = current (A)
- $R$  = resistance ( $\Omega$ )

- An electrical component obeys Ohm's law if its graph of current against potential difference is a **straight line** through the origin

- A **fixed resistor** obeys Ohm's law i.e. it is an **ohmic** component
- A **filament lamp** does **not** obey Ohm's law i.e. it is a **non-ohmic** component

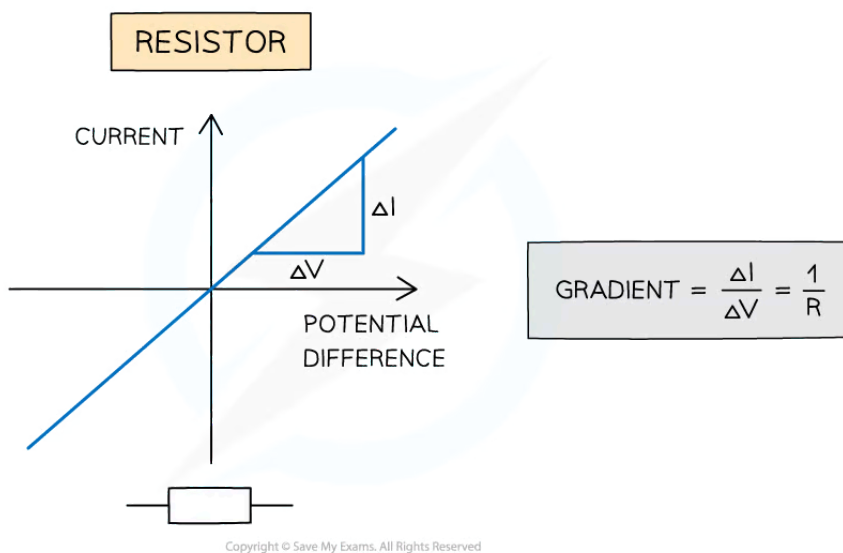

**The current-voltage graph for a fixed resistor is a straight line through the origin. The fixed resistor is an ohmic component**

- The resistance of an ohmic component can be calculated from the **gradient** of a current-voltage graph, since resistance is equal to

$$R = \frac{V}{I}$$

- If **current  $I$**  is on the  **$y$ -axis** and **potential difference  $V$**  is on the  **$x$ -axis**, then  $R = \frac{1}{\text{gradient}}$
- If **potential difference  $V$**  is on the  **$y$ -axis** and **current  $I$**  is on the  **$x$ -axis**, then  $R = \text{gradient}$
- Any metal conductor at a **constant temperature** can be considered an **ohmic** device
  - This is likely to be a fixed resistance
- Non-ohmic devices include:
  - Lamps
  - LEDs
  - Thermistors



Your notes

### Worked example

The current flowing through a component varies with the potential difference  $V$  across it as shown.



Which graph best represents how the resistance  $R$  varies with  $V$ ?

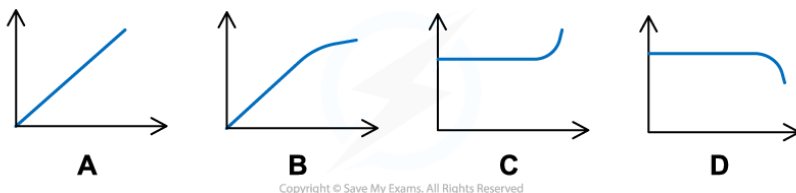

**Answer: D**

**Step 1: Write down the equation for the resistance  $R$**

$$R = \frac{V}{I}$$

**Step 2: Link the resistance to the gradient of the graph**

$$\text{gradient} = \frac{I}{V} \Rightarrow R = \frac{1}{\text{gradient}}$$

**Step 3: Identify the gradient of different sections of the graph and use it to deduce what happens to the resistance**

- The first straight section of the graph has a constant gradient
  - So the resistance remains constant
- The second section is curved and the steepness of the line increases, so the gradient increases
  - So the resistance decreases

**Step 4: Identify the correct graph out of the four proposed**

- Constant resistance is indicated by a straight horizontal line
  - So either **C** or **D** are correct
- Decreasing resistance is indicated by a line curving downwards
  - So only **D** is correct





Your notes

### Examiner Tip

When solving problems about Ohm's law you will often deal with graphs. You need to be confident in identifying and calculating their gradients.

- In maths, the gradient is the **slope** of the graph (i.e.  $\frac{\text{rise}}{\text{run}}$ )
- The graphs below show a summary of how the slope of the graph represents the gradient

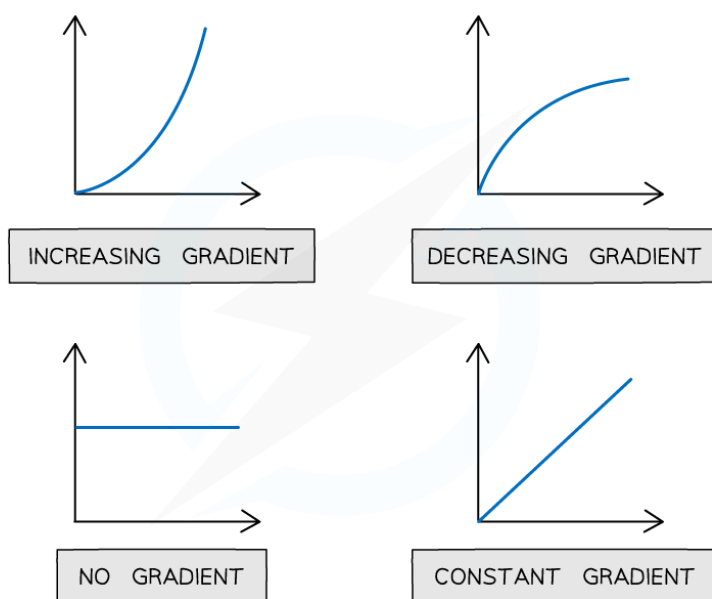

Copyright © Save My Exams. All Rights Reserved

Although the Ohm's law equation is not given on your data sheet, you can see it is just rearranging

$$R = \frac{V}{I} \text{ to make } V \text{ the subject.}$$



Your notes

## I-V Characteristics

- The Ohmic and non-Ohmic behaviour of an electrical conductor can be deduced by looking at its  $I$ - $V$  (current-voltage) characteristics
  - This is usually plotted as a graph showing the variation of current against voltage
- The relation between potential difference across an electrical component (e.g. a fixed resistor) and current can be investigated through a circuit such as the one below

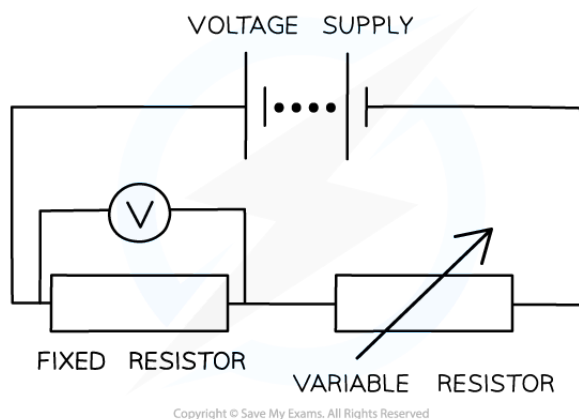

**Circuit for plotting graphs of current against voltage. The component being investigated here is a fixed resistor**

- By adjusting the resistance on the variable resistor:
  - The **current** in the circuit will **change**
  - For each value of the current  $I$ , the **potential difference**  $V$  can be **recorded**
- A graph of current against potential difference can then be plotted

## $I$ - $V$ characteristics of common conductors

- Common ohmic conductors include
  - Wires (at constant temperature)
  - Resistors
- Common non-ohmic conductors include
  - Semiconductor diodes e.g. LEDs
  - Filament lamp
  - Thermistors & light-dependent resistors (LDRs)



Your notes

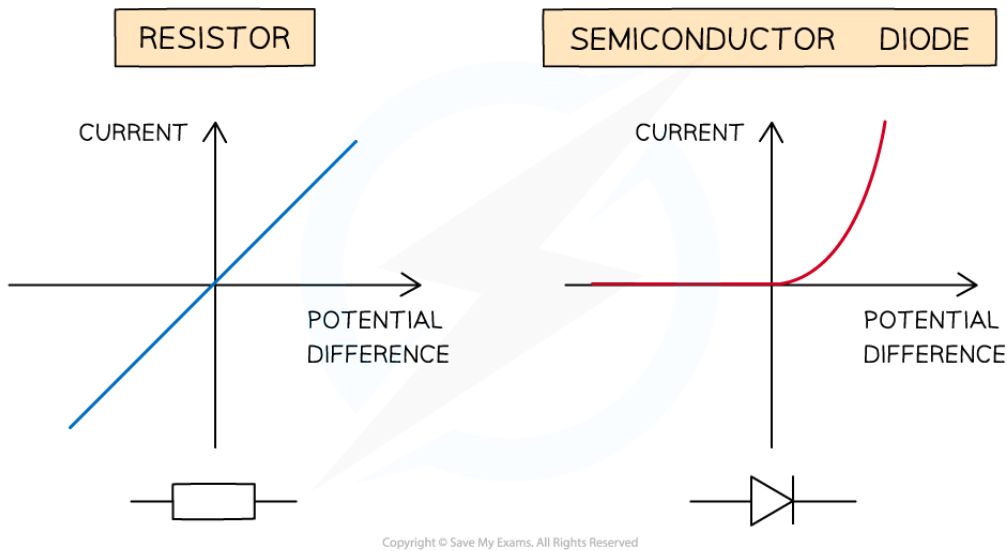

*I-V characteristics for an ohmic conductor (e.g. resistor) and semiconductor diode (e.g. LED)*

## Resistor

- A resistor is an example of an Ohmic resistor
  - This means the current is **directly proportional** to the potential difference
  - Its *I-V* graph is a **straight line** through the origin

## Semiconductor Diode

- When the current is in the direction of the arrowhead symbol, the diode is said to be **forward-biased**
  - There is a sharp increase in current
  - This is shown on the right side of the graph
- When the diode is switched around, it does not conduct and it is said to be **reverse biased**
  - The current through the diode is zero
  - This is shown on the left side of the graph
- The diode is a **non-ohmic** component
  - Its *I-V* graph is not a straight line through the origin
- A specific type of diode is an **LED**
  - The *I-V* characteristic graphs looks the exact same for this

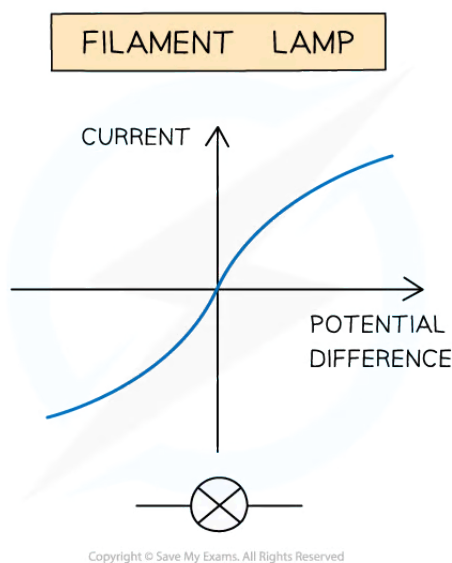

*I-V characteristics for a filament lamp*

## Filament Lamp

- For **very small voltages**, the filament lamp behaves as an **ohmic** component
  - The middle section of the graph (around zero voltage) is straight and passes through the origin
- As voltage increases:
  - More current flows through the filament lamp and the **temperature** of the filament in the lamp **increases**
  - The **higher** the **temperature** of the filament, the **higher** its **resistance**
  - Since resistance opposes current, the **current flows** through the filament **at a slower rate**
  - This is shown by the curved section of the graph
- For slightly **higher voltages**, the filament lamp is **non-ohmic**
  - The *I-V* graph is a curve with decreasing gradient

### Examiner Tip

Make sure you're confident in drawing the *I-V* characteristics for different components, as you may be asked to sketch these from memory or to identify those given in exam questions



Your notes

## Series & Parallel Circuits

### Series & Parallel Circuits

#### Resistors in Series

- In a **series** circuit:
  - The **current** is the **same** at any point
  - The **potential difference** is **split** across all components depending on their resistance
- When two or more components are connected in series:
 

**The combined resistance of the components is equal to the sum of individual resistances**
- Three resistors connected in series will have a **total resistance** of  $R = R_1 + R_2 + R_3$

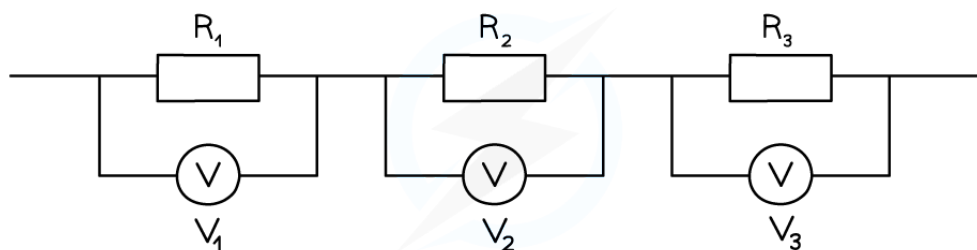

Copyright © Save My Exams. All Rights Reserved

#### **Resistors in series**

- The equation for the total resistance of **resistors in series** is derived using the above rules for current and potential difference:

CONSIDER TWO RESISTORS  $R_1$  AND  $R_2$  CONNECTED IN SERIES  
A SINGLE RESISTOR  $R$  IS EQUIVALENT TO THEM

FROM THE ELECTRIC CURRENT RULE: THE CURRENT  $I$  THROUGH EACH RESISTOR IS THE SAME SINCE THEY ARE CONNECTED IN SERIES (NO JUNCTIONS)

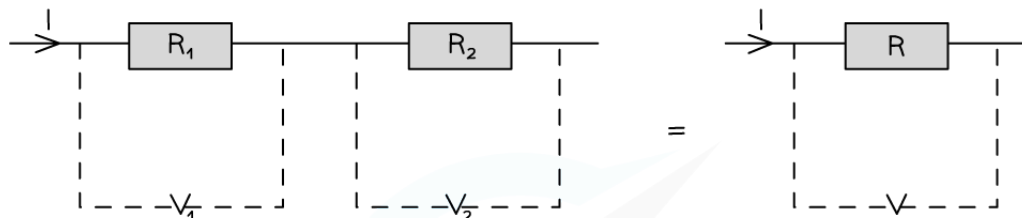

FROM THE ELECTRICAL VOLTAGES RULE: THE TOTAL p.d OF BOTH RESISTORS IN A CLOSED CIRCUIT LOOP MUST EQUAL THE SUM OF THE p.ds (THE p.d ACROSS THE SINGLE RESISTOR)

$$V = V_1 + V_2$$

FROM OHM'S LAW, POTENTIAL DIFFERENCE IS GIVEN BY THE PRODUCT OF CURRENT AND RESISTANCE

$$IR = IR_1 + IR_2$$

SINCE CURRENT  $I$  IS THE SAME FOR ALL RESISTORS, DIVIDING BY  $I$

$$R = R_1 + R_2$$

THIS EQUATION CAN BE EXTENDED SO THE EQUIVALENT RESISTOR  $R$  OF SEVERAL RESISTORS CONNECTED IN SERIES IS GIVEN BY

$$R = R_1 + R_2 + R_3 + R_4 \dots$$

Copyright © Save My Exams. All Rights Reserved

- The equation for the combined resistance of resistors in series is therefore:

COMBINED RESISTANCE IN SERIES  $R = R_1 + R_2 + R_3 \dots$

Copyright © Save My Exams. All Rights Reserved

- This means the **total resistance increases**
  - The combined resistance is **more** than the resistance of any of the individual components



Your notes

- For example, if two resistors of equal resistance are connected in series, then the combined resistance will **double**

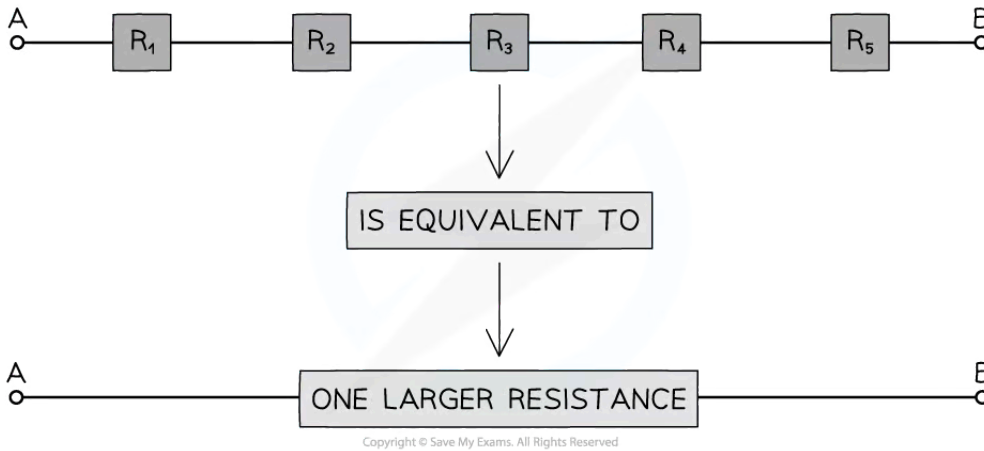

**Connecting more resistors in series increases the overall resistance**

### Resistors in Parallel

- In a **parallel** circuit:
  - The total **current** is equal to the **sum** of the currents in each parallel **branch** of the circuit
  - The **potential difference** is the same across each loop
- In a parallel circuit, the combined resistance of the components requires the use of **reciprocals**  
**The reciprocal of the combined resistance of two or more resistors is the sum of the reciprocals of the individual resistances**

- Two resistors connected in parallel will have a **total resistance** of  $\frac{1}{R} = \frac{1}{R_1} + \frac{1}{R_2}$

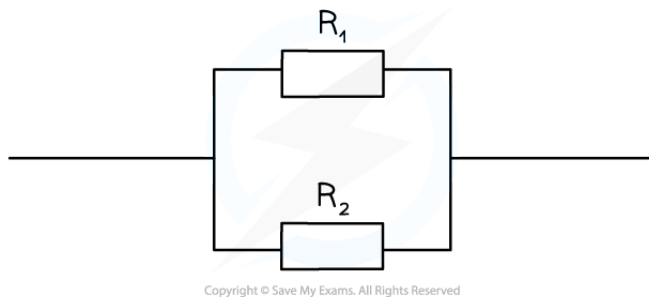

### Resistors in parallel

- The equation for the total resistance of **resistors in parallel** is derived using the above rules for current and potential difference:

CONSIDER TWO RESISTORS  $R_1$  AND  $R_2$  CONNECTED IN PARALLEL  
 A SINGLE RESISTOR  $R$  IS EQUIVALENT TO THEM

FROM THE ELECTRICAL CURRENT RULE: THE CURRENT THROUGH EACH  
 RESISTOR WILL BE DIFFERENT DUE TO THE CURRENT SPLITTING AT  
 THE JUNCTION

THE CURRENT THROUGH THE EQUIVALENT RESISTOR  $R$  WILL BE THE  
 TOTAL CURRENT  $I$

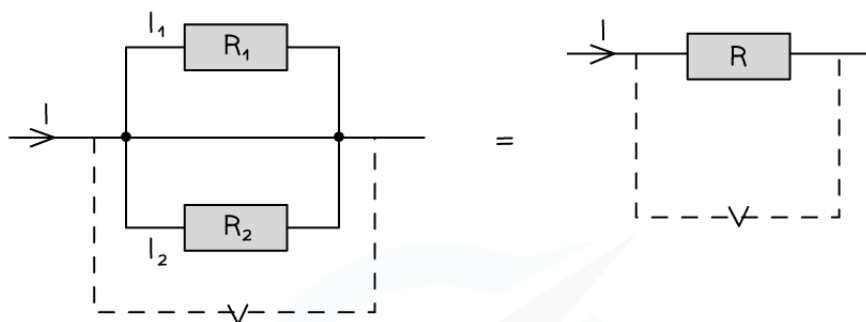

$$I = I_1 + I_2$$

FROM THE ELECTRICAL VOLTAGES RULE: THE p.d ACROSS EACH  
 RESISTOR IN DIFFERENT BRANCHES IS THE SAME  
 THE RESISTOR  $R$  WILL HAVE THAT SAME p.d ACROSS IT TOO

$$V = V_1 = V_2$$

REARRANGING OHM'S LAW  $V = IR$  FOR CURRENT  $I$

$$I = \frac{V}{R}$$

$$\frac{V}{R} = \frac{V}{R_1} + \frac{V}{R_2}$$

SINCE POTENTIAL DIFFERENCE  $V$  IS THE SAME FOR ALL RESISTORS,  
 DIVIDING BY  $V$

$$\frac{1}{R} = \frac{1}{R_1} + \frac{1}{R_2}$$

THIS EQUATION CAN BE EXTENDED SO THE EQUIVALENT RESISTOR  $R$   
 OF SEVERAL RESISTORS CONNECTED IN PARALLEL IS GIVEN BY

$$\frac{1}{R} = \frac{1}{R_1} + \frac{1}{R_2} + \frac{1}{R_3} \dots$$

Copyright © Save My Exams. All Rights Reserved





Your notes

- The equation for the combined resistance of resistors in parallel is therefore:

COMBINED RESISTANCE IN PARALLEL	$\frac{1}{R} = \frac{1}{R_1} + \frac{1}{R_2} + \frac{1}{R_3} \dots$
------------------------------------	---

Copyright © Save My Exams. All Rights Reserved

- This means the **total resistance decreases**
  - The combined resistance is **less** than the resistance of any of the individual components
  - For example, if two resistors of equal resistance are connected in parallel, then the combined resistance will **halve**

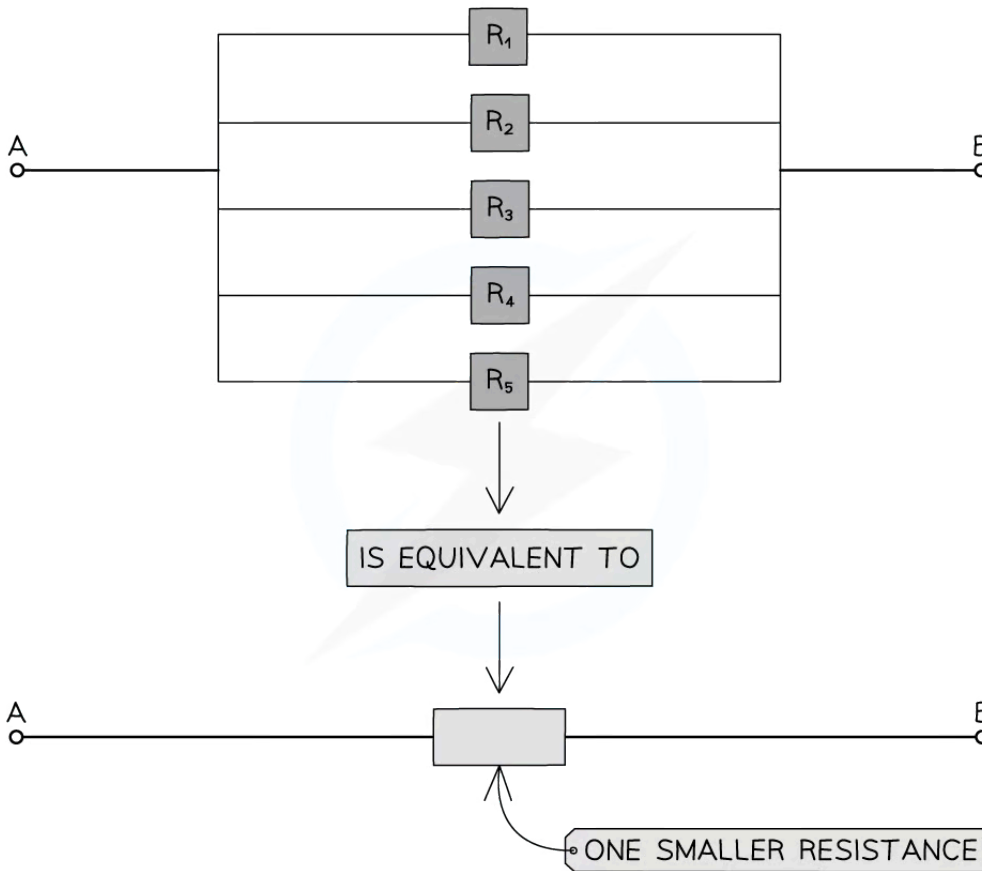

Copyright © Save My Exams. All Rights Reserved

**Connecting more resistors in parallel decreases the overall resistance**

### Summary of the rules in series and parallel circuits

- The table below summarises the rules for calculating current, potential difference and resistance within series and parallel circuits

#### Series and Parallel Circuits Summary

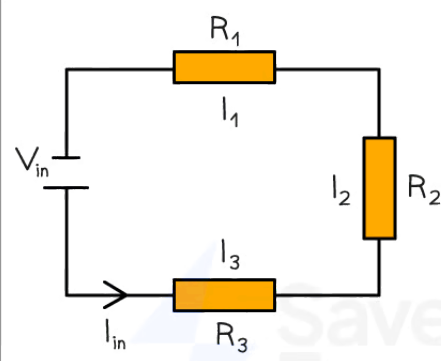
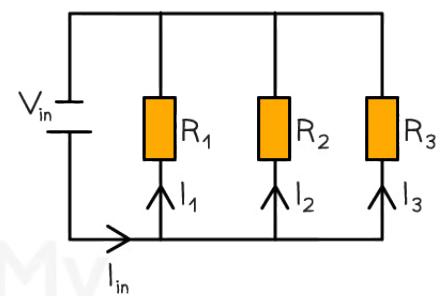

Your notes

	Series	Parallel
<b>Circuit</b>		
<b>Voltage</b>	$V_{in} = V_1 + V_2 + V_3$	$V_{in} = V_1 = V_2 = V_3$
<b>Current</b>	$I_{in} = I_1 = I_2 = I_3$	$I_{in} = I_1 + I_2 + I_3$
<b>Resistance</b>	$R_s = R_1 + R_2 + R_3$	$\frac{1}{R_p} = \frac{1}{R_1} + \frac{1}{R_2} + \frac{1}{R_3}$

Copyright © Save My Exams. All Rights Reserved

### Worked example

For the circuit below, state the readings of ammeters  $A_1$ ,  $A_2$  and  $A_3$ .

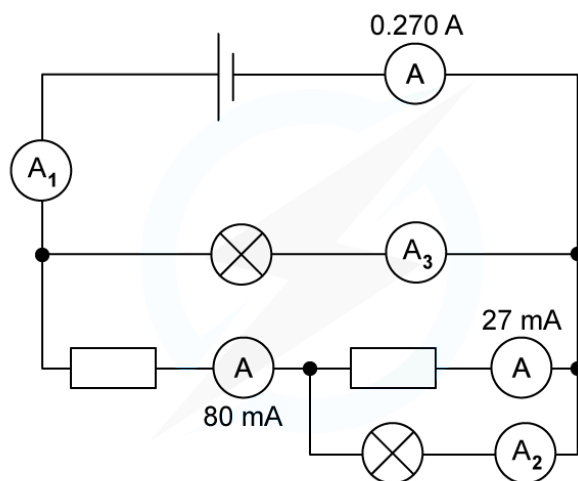

Copyright © Save My Exams. All Rights Reserved

**Answer:**

#### Step 1: Recall the rules for current in series & parallel

- In a **series** circuit: The current is the same at any point  $I_{in} = I_1 = I_2 = I_3$
- In a **parallel** circuit: The total current is equal to the sum of the currents in each parallel branch of the circuit  $I_{in} = I_1 + I_2 + I_3$

#### Step 2: Determine the current in ammeter $A_1$

- Ammeter  $A_1$  is in series with ammeter A
- Therefore, the current in  $A_1$  = the current in A

$$A_1 = 0.270 \text{ A}$$

#### Step 3: Determine the current in ammeter $A_3$

- The current from ammeter  $A_1$  enters splits into two branches
- One branch has a current of  $80 \text{ mA} = 0.080 \text{ A}$
- The current in the other branch is the reading of ammeter  $A_3$

$$0.270 = 0.080 + A_3$$

$$A_3 = (0.270 - 0.080) = 0.190 \text{ A}$$

#### Step 4: Determine the current in ammeter $A_2$

- The current of  $0.080 \text{ A}$  splits into two branches
- One branch has a current of  $27 \text{ mA} = 0.027 \text{ A}$

- The current in the other branch is the reading of ammeter  $A_2$

$$0.080 = 0.027 + A_2$$

$$A_2 = (0.080 - 0.027) \text{ A} = 0.053 \text{ A}$$

- The current readings of the three ammeters are:

- $A_1 = 0.270 \text{ A} = 270 \text{ mA}$
- $A_2 = 0.053 \text{ A} = 53 \text{ mA}$
- $A_3 = 0.19 \text{ A} = 190 \text{ mA}$



Your notes



Your notes

### Worked example

For the circuit below, state the readings of the voltmeters  $V_1$ ,  $V_2$  and  $V_3$ .

All the lamps and resistors have the same resistance.

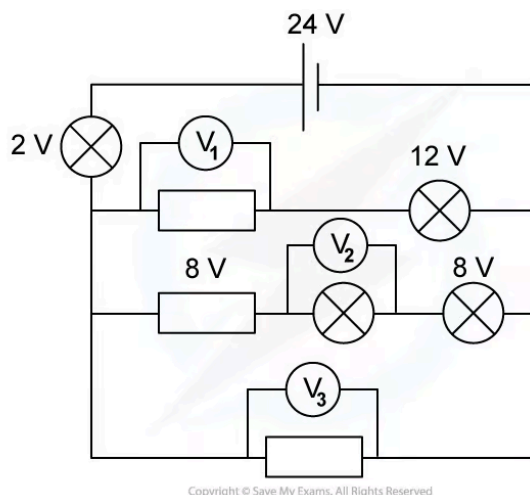

**Answer:**

#### Step 1: Recall the rules for p.d. in series & parallel

- In a **series** circuit: The potential difference is split across all components (equally if the resistance is equal)  $V_{in} = V_1 + V_2 + V_3$
- In a **parallel** circuit: The potential difference is the same across each loop  $V_{in} = V_1 = V_2 = V_3$

#### Step 2: Determine the p.d. in voltmeter $V_1$

- The potential difference provided by the cell is the total input p.d., so, each loop must sum to 24 V
- The first loop consists of the 2 V lightbulb, the 12 V lightbulb and resistor  $V_1$

$$2 + 12 + V_1 = 24 \text{ V}$$

$$V_1 = 24 - 2 - 12 = 10 \text{ V}$$

#### Step 3: Determine the p.d. in voltmeter $V_2$

- The second loop consists of the 2 V lightbulb, the 8 V resistor, lightbulb  $V_2$ , and the 8 V lightbulb

$$2 + 8 + V_2 + 8 = 24 \text{ V}$$

$$V_2 = 24 - 2 - 8 - 8 = 6 \text{ V}$$

#### Step 3: Determine the p.d. in voltmeter $V_3$

- The third loop consists of the 2 V lightbulb and resistor  $V_3$

$$2 + V_3 = 24 \text{ V}$$

$$V_3 = 24 - 2 = 22 \text{ V}$$

- The potential difference readings of the three voltmeters are:
  - $V_1 = 10 \text{ V}$
  - $V_2 = 6 \text{ V}$
  - $V_3 = 22 \text{ V}$



Your notes

### Examiner Tip

The equations for current, potential difference and resistance in series and parallel circuits is given in your data booklet. However, it is much quicker if you remember them!



Your notes

## Electrical Power

### Electrical Power

- When an electrical current does work against electrical resistance:
  - Electrical energy is **dissipated as thermal energy** in the surroundings
  - The heat that is produced will dissipate via thermal conduction, convection and radiation
- The amount of heat produced depends on two factors:
  - Current:** The greater the current, the more heat that is produced
  - Resistance:** The higher the resistance, the greater the amount of heat produced (for a given current)
- Note that reducing the resistance can cause the current to increase
  - This could actually **increase** the amount of heat produced
- In mechanics, power  $P$  is defined as the **rate of doing work**
  - The potential difference is the **work done per unit charge**
  - Current is the **rate of flow of charge**
- Therefore, the electrical power is defined as the **rate of change of work done:**

$$P = \frac{E}{t} = \frac{W}{t}$$

- Where:
  - $P$  = power (W)
  - $E$  = energy transferred (J)
  - $W$  = work done (J)
  - $t$  = time (s)
- The work done is the energy transferred so the power is the **energy transferred per second** in an electrical component
- The power dissipated (produced) by an electrical device can also be written as

$$P = IV$$

- Where:
  - $I$  = current (A)
  - $V$  = potential difference (V)
- Using Ohm's Law  $V = IR$  to rearrange for either  $V$  or  $I$  and substituting into the power equation, means power can be written in terms of resistance  $R$

$$P = I^2 R = \frac{V^2}{R}$$

- Where  $R$  = resistance ( $\Omega$ )
- This means that, for a given resistor, **doubling** the current (or voltage) will yield an electrical power **four** times greater
- Rearranging the energy and power equation, the energy transferred can be written as:

$$E = VIt$$



Your notes





Your notes

### Worked example

Two lamps are connected in series to a 150 V power supply.

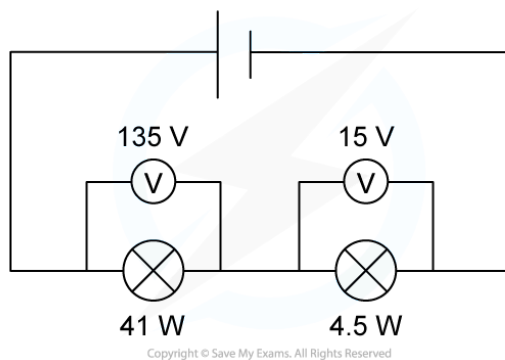

Which statement most accurately describes what happens?

- A. Both lamps light normally
- B. The 15 V lamp blows
- C. Only the 41 W lamp lights
- D. Both lamps light at less than their normal brightness

**ANSWER: A**



Your notes

STEP 1 CALCULATE CURRENT NEEDED FOR BOTH LAMPS TO OPERATE

$$P = IV$$

STEP 2 REARRANGE FOR I

$$I = \frac{P}{V}$$

STEP 3 FOR THE 41 W LAMP:  $I = \frac{41 \text{ W}}{135 \text{ V}} = 0.3 \text{ A}$

FOR THE 4.5 W LAMP:  $I = \frac{4.5 \text{ W}}{15 \text{ V}} = 0.3 \text{ A}$

STEP 4 FOR BOTH TO OPERATE AT THEIR NORMAL BRIGHTNESS, A CURRENT OF 0.3 A IS REQUIRED.  
SINCE THE LAMPS ARE CONNECTED IN SERIES, THE SAME CURRENT WOULD FLOW THROUGH BOTH.

STEP 5 THE LAMPS WILL LIGHT AT THEIR NORMAL BRIGHTNESS – OPTION A

Copyright © Save My Exams. All Rights Reserved

### Examiner Tip

You can use the mnemonic “Twinkle Twinkle Little Star, Power equals  $I$  squared  $R$ ” to remember whether to multiply or divide by resistance in the power equations, although they are all given in your data booklet.

The most appropriate equation to use will depend on whether the value of current or voltage has been given in the question



Your notes

## Sources of Electrical Energy

### Sources of Electrical Energy

- An electric cell stores chemical energy that can be transferred to electrical energy
- Electric cells, batteries and other sources of electrical energy come in many forms, such as
  - Chemical cells
  - Solar cells
  - Mains electricity
  - Wind generators

### Chemical Cells

- Batteries, or chemical cells, utilise chemical reactions to provide a potential difference
  - They can be rechargeable or non-rechargeable
- Non-rechargeable batteries are by definition, only able to be **used once** as the chemicals within them are used up
  - Examples include alkaline, or AA batteries, common in many small devices
- Rechargeable cells can be **used many times** as they are attached to a charger and the **chemical reaction** is **reversed** allowing the cells to store energy for use once again
- Examples include:
  - Lithium-ion batteries used in laptops and other mobile devices
  - Lead-acid batteries such as those used in cars and other motor vehicles

### Solar Cells

- Photovoltaic cells in solar panels convert **electromagnetic radiation** (photons) from the Sun into **electrical** energy
- When photons from the Sun are incident on the **solar heating panels**, the **light** energy is transferred into **thermal** energy
- The solar photons are absorbed by **electrons** on the surface of the photovoltaic cells, giving them enough energy to move and be **released** from the surface
- These electrons transfer the **thermal** energy into **electrical** energy which is then transferred to the external circuit

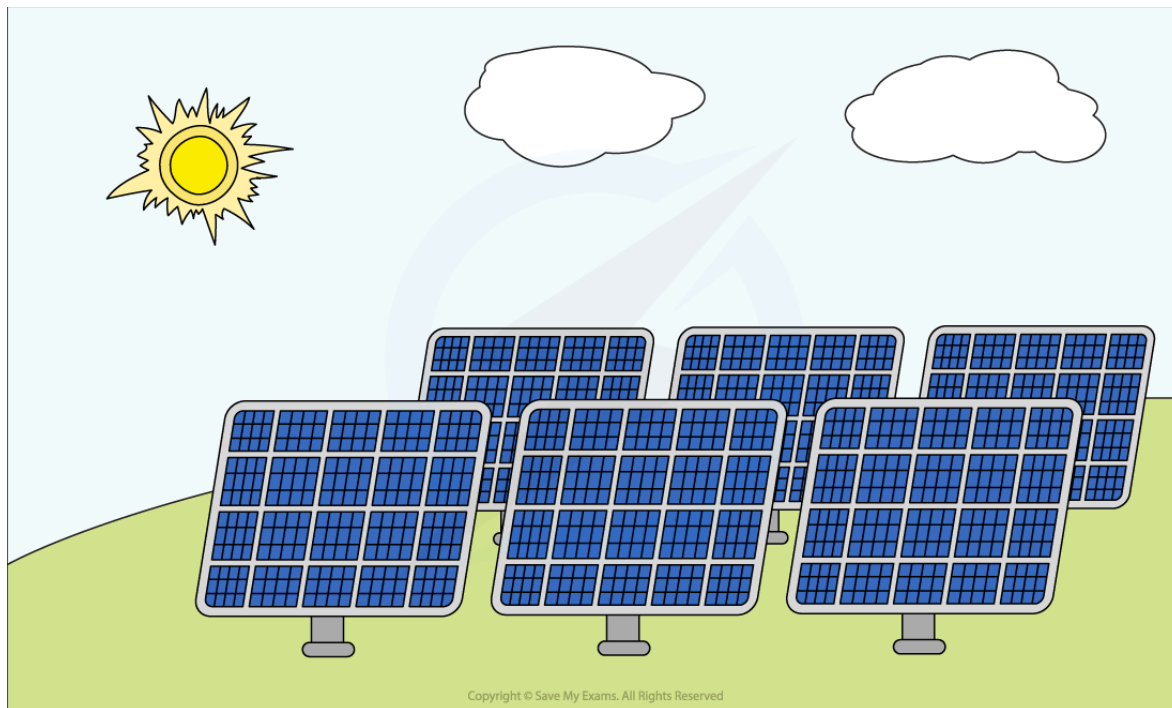

**Solar panels use solar cells to transfer energy from electromagnetic radiation into electrical energy**

## Advantages & Disadvantages

- Each energy source has its advantages and disadvantages, some of these are shown in the following table

Battery type	Advantages	Disadvantages
Single-use battery (e.g. alkaline AA battery)	<ul style="list-style-type: none"> <li>high energy density</li> <li>convenient source of energy used in everyday appliances</li> <li>portable source of electrical energy</li> <li>potential to join many in series to increase p.d.</li> <li>low cost</li> </ul>	<ul style="list-style-type: none"> <li>non-rechargeable/limited power supply and will need replacing</li> <li>high internal resistance</li> <li>disposal issues/contributes to pollution</li> <li>made from non-renewable materials</li> </ul>
Mobile phone battery (e.g. lithium-ion battery)	<ul style="list-style-type: none"> <li>very high energy density</li> <li>high electrical efficiency</li> </ul>	<ul style="list-style-type: none"> <li>capacity of the cell degrades over time</li> <li>internal resistance increases over time</li> </ul>



Your notes

	<p>convenient source of energy used in everyday appliances</p> <p>rechargeable, long lifetime</p> <p>fast charging time</p> <p>portable source of electrical energy</p> <p>low internal resistance</p>	<p>expensive</p>
Car battery (e.g. lead-acid battery)	<p>low cost</p> <p>rechargeable</p> <p>able to deliver very high currents in a short time</p>	<p>low energy density – very heavy compared to power output</p> <p>internal resistance increases as battery degrades</p> <p>limited number of full discharge cycles</p> <p>disposal issues/contributes to pollution, uses toxic and corrosive materials</p> <p>made from non-renewable materials</p>
Solar cell	<p>unlimited supply of energy</p> <p>clean to produce the electricity</p> <p>freely available everywhere</p> <p>cheap maintenance</p> <p>no fuel is required for energy</p>	<p>variable output, highly dependent on weather conditions</p> <p>impacted by poor weather</p> <p>limited efficiency</p> <p>only available during the day</p> <p>requires large investment upfront</p> <p>requires large areas</p>
Wind generator	<p>zero fuel costs, freely available</p> <p>no chemical pollution</p> <p>always sustainable and will never run out</p> <p>high set-up cost but becomes economical</p>	<p>inconsistent output, highly dependent on weather conditions</p> <p>requires favourable local conditions to be placed in windy locations</p> <p>noise/visual pollution</p>

Mains electricity (fossil fuel generator)	extensive infrastructure in place  high energy density of fuel  reliable/available energy at any time  well-known and developed technology	produces greenhouse gases  unsustainable (non-renewable)  produces pollution
---	--	--



Your notes

 **Examiner Tip**

You do not need to know the inner workings of all the cells. However, you must be able to compare the advantages and disadvantages of using each cell as an energy source.



Your notes

## Electromotive Force & Internal Resistance

### Electromotive Force

- When charge passes through a power supply such as a battery, it **gains** electrical energy
- The **electromotive force (e.m.f.)** is defined as  
**The amount of chemical energy converted to electrical energy per coulomb of charge (C) when charge passes through a power supply**
- Cells and batteries provide a **source** of e.m.f.
- E.m.f. is measured in **Volts (V)** and can be calculated using:

$$\text{E.M.F.} = \frac{\text{ENERGY TRANSFORMED FROM OTHER FORMS TO ELECTRICAL}}{\text{CHARGE}}$$

Copyright © Save My Exams. All Rights Reserved

- Emf is also the potential difference across the cell when **no** current is flowing
- The emf of a cell can be measured by connecting a high-resistance voltmeter around the terminals of the cell in an open circuit

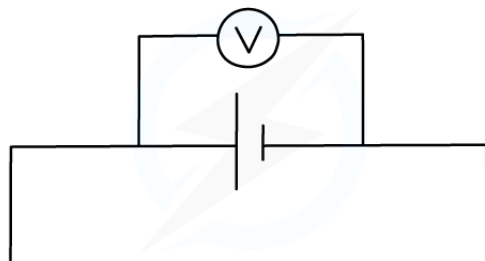

Copyright © Save My Exams. All Rights Reserved

***Emf is measured using a voltmeter connected in parallel with the cell***

## Internal Resistance

- All power supplies have some resistance between their terminals
  - This is called **internal resistance** ( $r$ )
- This internal resistance causes the charge circulating to dissipate some electrical energy from the power supply itself
  - This is why the cell becomes warm after a period of time
- The internal resistance therefore causes **loss of voltage** or energy loss in a power supply
- A cell can be thought of as a source of e.m.f with an internal resistance connected in series. This is shown in the circuit diagram below:

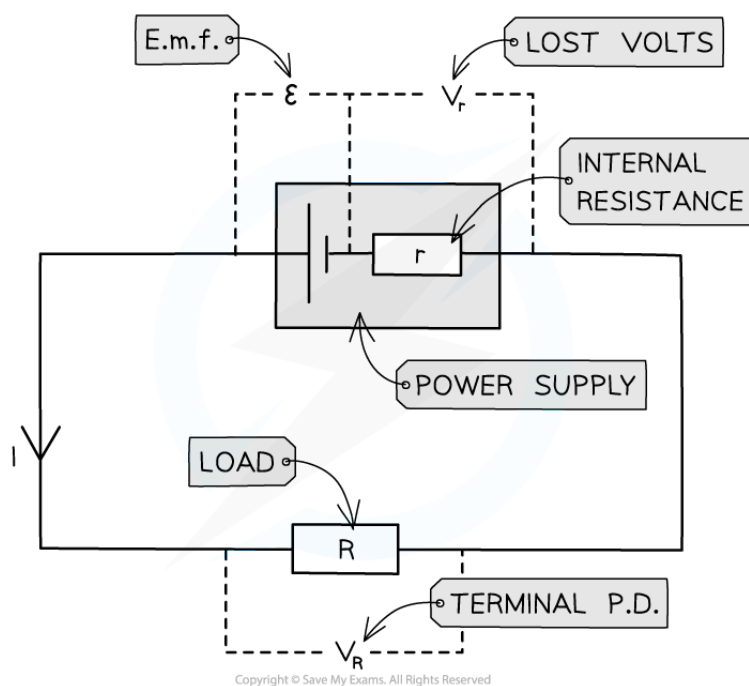

**Circuit showing the e.m.f and internal resistance of a power supply**

- Where:
  - Resistor  $R$  is the 'load resistor'
  - $r$  is the internal resistance
  - $\epsilon$  is the e.m.f
  - $V_r$  is the **lost volts**
  - $V_R$  is the p.d across the load resistor, which is the same as the terminal p.d
- $V_r$  is called the 'lost volts' as its the potential difference 'lost' due to the internal resistance in the cell



- The e.m.f is the **sum** of these **potential differences**, giving the equation below:

$$\varepsilon = I(R + r)$$

- Where:
  - $\varepsilon$  = electromotive force (emf) (V)
  - $I$  = current (A)
  - $R$  = resistance available to the rest of the circuit ( $\Omega$ )
  - $r$  = internal resistance ( $\Omega$ )
- Emf is, therefore, the total, or maximum, voltage available to the circuit



Your notes

### Worked example

A battery of e.m.f  $7.3\text{ V}$  and internal resistance  $r$  of  $0.3\ \Omega$  is connected in series with a resistor of resistance  $9.5\ \Omega$ .

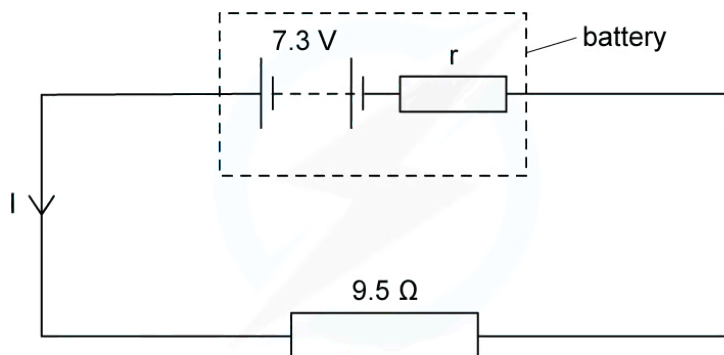

Copyright © Save My Exams. All Rights Reserved

Determine:

- the current in the circuit
- the lost volts from the battery

**Answer:**

a.)

STEP 1

USING THE e.m.f EQUATION TO DETERMINE THE CURRENT  $I$

$$E = I(R + r)$$

STEP 2

REARRANGE FOR  $I$

$$I = \frac{E}{(R + r)}$$

STEP 3

SUBSTITUTE IN THE VALUES

$$I = \frac{7.3}{(9.5 + 0.3)} = 0.745\dots = 0.7\text{ A (2 s.f.)}$$

b.)

STEP 1

THE LOST VOLTS IS THE VOLTAGE LOST DUE TO INTERNAL RESISTANCE

$$\text{LOST VOLTS} = I \times r$$

STEP 2

SUBSTITUTE IN THE VALUES

$$\text{LOST VOLTS} = 0.7 \times 0.3 = 0.21 = 0.2 \text{ (2 s.f.)}$$

Copyright © Save My Exams. All Rights Reserved

 **Examiner Tip**

Make sure you substitute the correct resistance into the emf equation.  $R$  is the resistance available **to the rest of the circuit** and can vary depending on what components are in the circuit (e.g. adding or taking away resistors). The internal resistance  $r$  is a property of the **cell** and cannot change.



Your notes



Your notes

## Variable Resistance

### Variable Resistance

#### Thermistors

- A thermistor is a non-ohmic conductor and sensory resistor whose resistance varies with temperature
- Most thermistors are negative temperature coefficient (ntc) components.
  - This means that if the temperature **increases**, the resistance of the thermistor **decreases** (and vice versa)
- The temperature-resistance graph for a thermistor is shown below

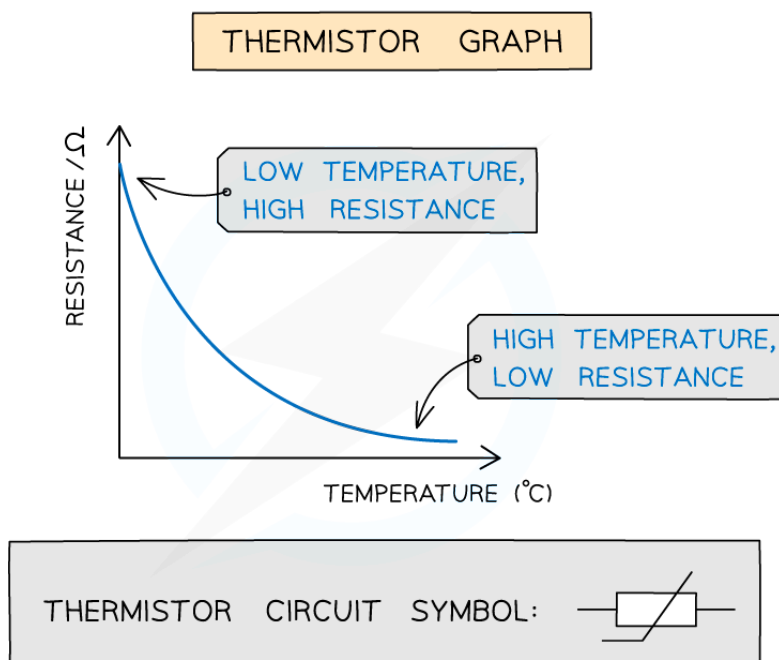

Copyright © Save My Exams. All Rights Reserved

#### *Graph of temperature against resistance for a thermistor*

- Thermistors are temperature sensors and are used in circuits in ovens, fire alarms and digital thermometers
  - As the thermistor gets **hotter**, its resistance **decreases**
  - As the thermistor gets **cooler**, its resistance **increases**



Your notes

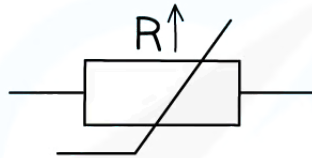
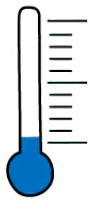

LOW TEMPERATURE  
HIGH RESISTANCE

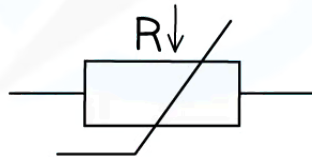

HIGH TEMPERATURE  
LOW RESISTANCE

Copyright © Save My Exams. All Rights Reserved

*The resistance through a thermistor is dependent on the temperature of it*

## Light-dependent resistors (LDR)

- A light-dependent resistor (LDR) is a non-ohmic conductor and sensory resistor
- Its resistance automatically changes depending on the light energy falling onto it (illumination)
- This is shown by the following graph:



Your notes

LDR GRAPH

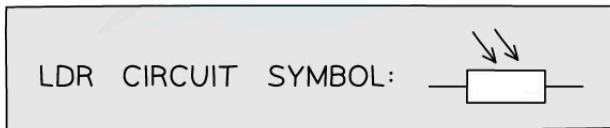
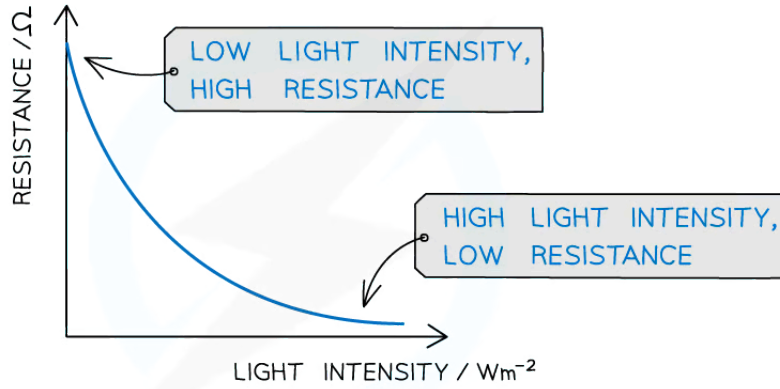

Copyright © Save My Exams. All Rights Reserved

**Graph of light intensity and resistance for an LDR**

- As the **light intensity** increases, the **resistance** of an LDR decreases

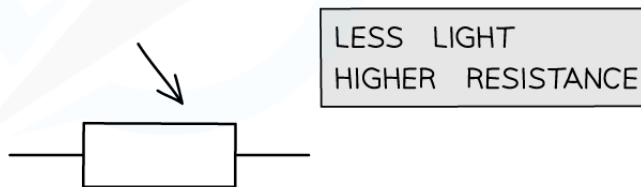
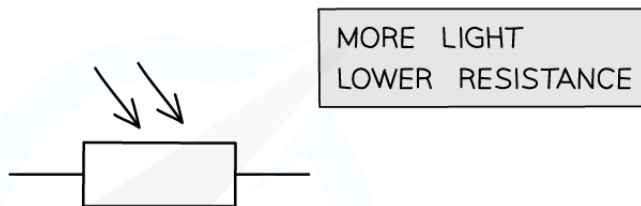

Copyright © Save My Exams. All Rights Reserved

### Resistance of an LDR depends on the light intensity falling on it

- LDRs can be used as light sensors, so, they are useful in circuits which automatically switch on lights when it gets dark, for example, street lighting and garden lights
  - In the dark, its resistance is very large (millions of ohms)
  - In bright light, its resistance is small (tens of ohms)



Your notes

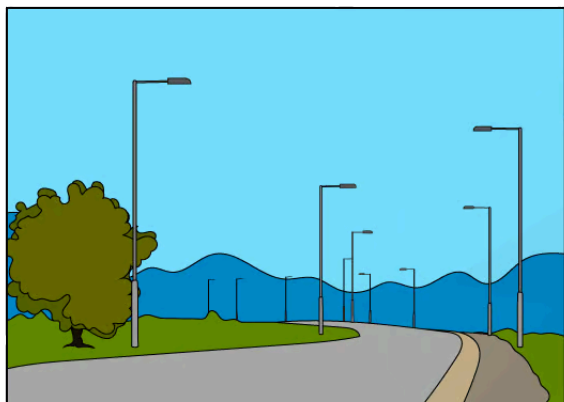

DAYTIME HAS HIGH LIGHT INTENSITY → LDR KEEPS LIGHTS TURNED OFF



AT NIGHT, THERE IS LOW LIGHT INTENSITY → LDR SWITCHES LIGHTS ON

Copyright © Save My Exams. All Rights Reserved

### LDRs are used for automatic street lights

## Potentiometer

- A potentiometer is similar to a variable resistor connected as a potential divider to give a continuously variable output voltage
- It can be used as a means of comparing potential differences in different parts of the circuit
- It is recognised on a circuit diagram with a resistor fitted with a sliding contact
- The sliding contact has the effect of separating the potentiometer into two parts (an upper part and a lower part), both of which have different resistances



Your notes

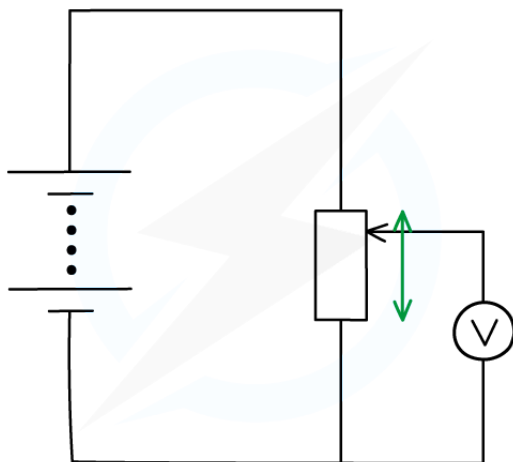

Copyright © Save My Exams. All Rights Reserved

***Moving the slider (the arrow in the diagram) changes the resistance (and hence potential difference) of the upper and lower parts of the potentiometer***

- If the slider in the above diagram is moved upwards, the resistance of the lower part will increase and so the potential difference across it will also increase
- Therefore, the variable resistor obtains a maximum or minimum value for the output voltage
- If the resistance is  $3\ \Omega$ :
  - Maximum voltage is when the resistance is  $3\ \Omega$
  - Minimum voltage is when the resistance is  $0\ \Omega$





Your notes

### Worked example

A thermistor is connected in series with a resistor  $R$  and a battery.

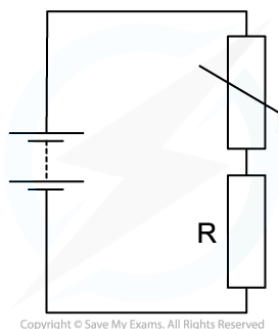

The resistance of the thermistor is equal to the resistance of  $R$  at room temperature. When the temperature of the thermistor decreases, which statement is correct?

- A. The p.d across the thermistor increases
- B. The current in  $R$  increases
- C. The current through the thermistor decreases
- D. The p.d across  $R$  increases

**ANSWER: A**

- The resistance of the thermistor increases as the temperature decreases
- Since the thermistor and resistor  $R$  are connected in series, the current  $I$  in both of them is the same
- Ohm's law states that  $V = IR$
- Since the resistance of the thermistor increases, and  $I$  is the same, the potential difference  $V$  across it increases
- Therefore, statement **A** is correct



Your notes

### Worked example

Which graph best represents the way in which the current  $I$  through an LDR depends upon the potential difference  $V$  across it?

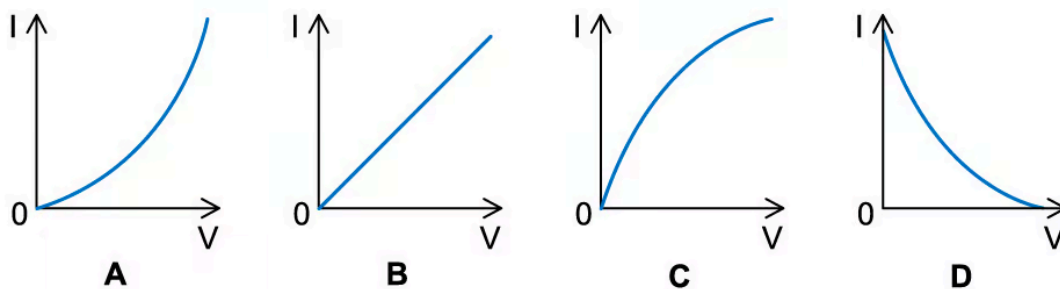

**ANSWER: B**

- As the potential difference across the LDR increases, the light intensity increases causing its resistance to decrease
- Ohm's law states that  $V = IR$
- The resistance is equal to  $V/I$  or  $1/R = I/V = \text{gradient of the graph}$
- Since  $R$  decreases, the value of  $1/R$  increases, so the gradient must increase
- Therefore,  $I$  increases with the p.d with an increasing gradient