

HL IB Chemistry



Your notes

The Covalent Model

Contents

- * Covalent Bonds
- * Lewis Formulas
- * Multiple Bonds
- * Coordinate Bonds
- * Shapes of Molecules
- * Bond Polarity
- * Molecular Polarity
- * Giant Covalent Structures
- * Intermolecular Forces
- * Physical Properties of Covalent Substances
- * Chromatography
- * Resonance Structures (HL)
- * Benzene (HL)
- * Expansion of the Octet (HL)
- * Formal Charge (HL)
- * Sigma & Pi Bonds (HL)
- * Hybridisation (HL)



Your notes

Covalent Bonds

Covalent Bonds

What are covalent bonds?

- **Covalent** bonding occurs between two **non-metals**
- A covalent bond involves the **electrostatic attraction** between nuclei of two atoms and the electrons of their outer shells
- **No electrons** are **transferred** but only **shared** in this type of bonding
- When a covalent bond is formed, two **atomic orbitals** overlap and a **molecular orbital** is formed
- Covalent bonding happens because the electrons are more stable when attracted to two nuclei than when attracted to only one

Diagram to show the formation of a covalent bond in a hydrogen molecule

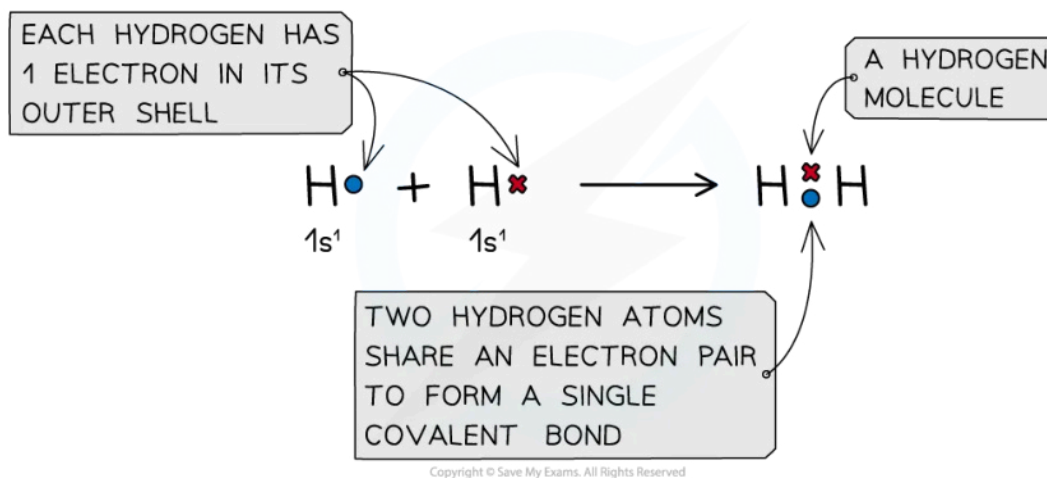

The positive nucleus of each atom has an attraction for the bonding electrons shared in the covalent bond

- In a normal covalent bond, each atom provides one of the electrons in the bond. A covalent bond is represented by a short straight line between the two atoms, H-H
- Covalent bonds should not be regarded as shared electron pairs in a fixed position; the electrons are in a state of constant motion and are best regarded as **charge clouds**

Hydrogen Molecular Orbital Diagram

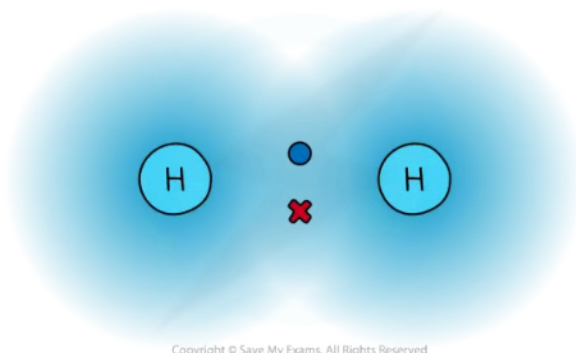

A representation of electron charge clouds. The electrons can be found anywhere in the charge clouds

- **Non-metals** are able to **share** pairs of electrons to form different types of covalent bonds
- Sharing electrons in the covalent bond allows each of the 2 atoms to achieve an electron configuration similar to a noble gas
 - This makes each atom more stable
- The **octet rule** refers to the tendency of atoms to gain a valence shell with a total of 8 electrons
- In some instances, the central atom of a covalently bonded molecule can accommodate **more** or **less** than 8 electrons in its outer shell
 - Being able to accommodate **more** than 8 electrons in the outer shell is known as '**expanding the octet rule**'
 - Accommodating **less** than 8 electrons in the outer shell means that the central atom is '**electron deficient**'
 - Some examples of this can be found in the section on Lewis structures

Examiner Tip

Covalent bonding takes place between two nonmetal atoms. Remember to use the periodic table to decide how many electrons are in the outer shell of a nonmetal atom.



Your notes

Lewis Formulas

Lewis Formulas

- **Lewis formulas** are simplified electron shell diagrams and show pairs of electrons around atoms.
- A pair of electrons can be represented by dots, crosses, a combination of dots and crosses or by a line.
For example, chlorine can be shown as:



Different Lewis Formulas for chlorine molecules

- Note: Cl-Cl is not a **Lewis formula**, since it does not show all the electron pairs.
- The “**octet rule**” refers to the tendency of atoms to gain a valence shell with a total of 8 electrons

Steps for drawing Lewis Formulas

1. Count the total number of **valence electrons**
2. Draw the **skeletal structure** to show how many atoms are linked to each other.
3. Use a pair of crosses or dot/cross to put an electron pair in each bond between the atoms.
4. Add more electron pairs to complete the octets around the atoms (except H which has 2 electrons)
5. If there are not enough electrons to complete the octets, form double/triple bonds.
6. Check the total number of electrons in the finished structure is equal to the total number of **valence electrons**

Worked example

Draw a Lewis formula for CCl_4 .

Answer:

- 1 TOTAL NUMBER OF VALENCE ELECTRONS = $\text{C} + 4\text{Cl} = 4 + (4 \times 7) = 32$
- 2 DRAW THE SKELETAL POSITIONS
- 3 ADD THE BONDING PAIRS
- 4 COMPLETED LEWIS FORMULA

ADD 24 LONE PAIR ELECTRONS

4 BONDING PAIRS MEANS $32 - 8 = 24$ ELECTRONS LEFT

LONE PAIRS

Copyright © Save My Exams. All Rights Reserved

Steps in drawing the Lewis formula for CCl_4

Further examples of Lewis formulas

- Follow the steps for drawing Lewis structures for these common molecules

Molecule	Total number of valence electrons	Lewis formula
CH_4	$\text{C} + 4\text{H}$ $4 + (4 \times 1) = 8$	$\begin{array}{c} \text{H} \\ \\ \text{H} : \text{C} : \text{H} \\ \\ \text{H} \end{array}$



NH ₃	$N + 3H$ $5 + (3 \times 1) = 8$	$\begin{array}{c} \cdot\cdot \\ H : \ddot{N} : H \\ \cdot\cdot \\ H \end{array}$
H ₂ O	$2H + O$ $(2 \times 1) + 6 = 8$	$\begin{array}{c} \cdot\cdot \\ H : \ddot{O} : \\ \cdot\cdot \\ H \end{array}$
CO ₂	$C + 2O$ $4 + (2 \times 6) = 16$	$\cdot\cdot \quad \cdot\cdot \quad \cdot\cdot \quad \cdot\cdot \\ \cdot\cdot : O : : C : : O : \cdot\cdot \\ \cdot\cdot \quad \cdot\cdot \quad \cdot\cdot \quad \cdot\cdot$
HCN	$H + C + N$ $1 + 4 + 5 = 10$	$H - C \equiv \ddot{N}$

Incomplete Octets

- For elements below atomic number 20 the **octet rule** states that the atoms try to achieve 8 electrons in their valence shells, so they have the same electron configuration as a noble gas
- However, there are some elements that are exceptions to the **octet rule**, such as H, Li, Be, B and Al
 - H can achieve a stable arrangement by gaining an electron to become $1s^2$, the same structure as the noble gas helium
 - Li does the same, but losing an electron and going from $1s^2 2s^1$ to $1s^2$ to become a Li^+ ion
 - Be from group 2, has two valence electrons and forms stable compounds with just four electrons in the valence shell
 - B and Al in group 13 have 3 valence electrons and can form stable compounds with only 6 valence electrons
- There are two examples of **Lewis structures** with incomplete octets you should know, $BeCl_2$ and BF_3 :

Molecule	Total number of valence electrons	Lewis formula
BeCl ₂	$Be + 2Cl =$ $2 + (2 \times 7) = 16$	$\cdot\cdot \quad \cdot\cdot \quad \cdot\cdot \quad \cdot\cdot \\ : \ddot{Cl} : \times Be : \times \ddot{Cl} : \\ \cdot\cdot \quad \cdot\cdot \quad \cdot\cdot \quad \cdot\cdot$
BF ₃	$B + 3F =$ $3 + (3 \times 7) = 24$	$\cdot\cdot \quad \cdot\cdot \quad \cdot\cdot \quad \cdot\cdot \quad \cdot\cdot \quad \cdot\cdot \\ \cdot\cdot : F : \cdot\cdot \\ \cdot\cdot \quad \cdot\cdot \quad \cdot\cdot \quad \cdot\cdot \quad \cdot\cdot \quad \cdot\cdot \\ \cdot\cdot : F : \times B : \times F : \cdot\cdot \\ \cdot\cdot \quad \cdot\cdot \quad \cdot\cdot \quad \cdot\cdot \quad \cdot\cdot \quad \cdot\cdot$

- Test your understanding of Lewis diagrams in the following example:

Worked example

How many electrons are in the 2-aminoethanoic acid molecule?

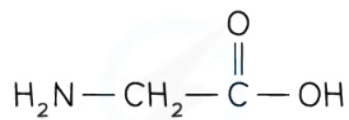

2-AMINOETHANOIC ACID

Copyright © Save My Exams. All Rights Reserved

- A. 18
- B. 20
- C. 28
- D. 30

Answer:

- The correct option is **D** because:
 - You must count the lone pairs on N and O as well as the bonding pairs. There are 5 'hidden' pairs of bonding electrons in the OH, CH₂ and NH₂ groups
 - Hydrogen does not follow the octet rule

Examiner Tip

Lewis formulas are also known as electron dot or Lewis structures.



Your notes



Your notes

Multiple Bonds

Multiple Bonds

- **Non-metals** are able to **share** more than one pair of electrons to form different types of covalent bonds
- Sharing electrons in the covalent bond allows each of the 2 atoms to achieve an electron configuration similar to a noble gas
 - This makes each atom more stable
- It is not possible to form a quadruple bond as the repulsion from having 8 electrons in the same region between the two nuclei is too great

Covalent Bonds & Shared Electrons Table

Type of covalent bond	Number of electrons shared
Single (C – C)	2
Double (C = C)	4
Triple (C ≡ C)	6

Bond energy

- The **bond energy** is the energy required to **break** one mole of a particular covalent bond in the gaseous states
 - Bond energy has units of kJ mol^{-1}
- The **larger** the bond energy, the **stronger** the covalent bond is

Bond length

- The **bond length** is **internuclear distance of two covalently bonded atoms**
 - It is the distance from the nucleus of one atom to another atom which forms the covalent bond
- The **greater** the forces of attraction between electrons and nuclei, the more the atoms are pulled closer to each other
- This **decreases** the **bond length** of a molecule and **increases** the **strength** of the covalent bond
- **Triple bonds** are the **shortest** and **strongest** covalent bonds due to the large electron density between the nuclei of the two atoms
- This increase the forces of attraction between the electrons and nuclei of the atoms

- As a result of this, the atoms are pulled closer together causing a shorter bond length
- The increased forces of attraction also means that the covalent bond is **stronger**



Your notes

Diagram to show bond lengths for carbon

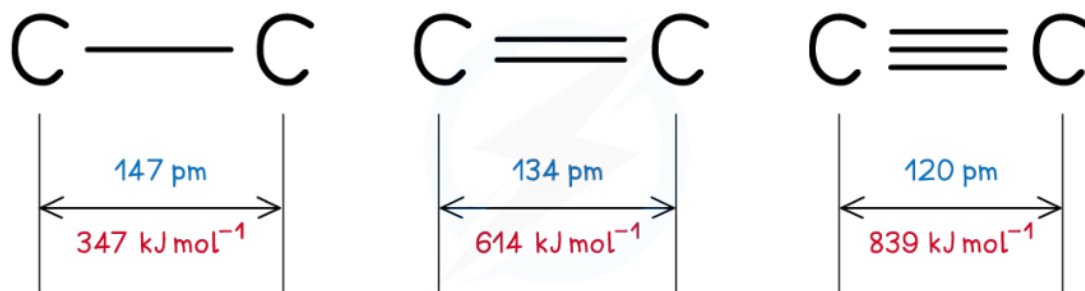

Copyright © Save My Exams. All Rights Reserved

Triple bonds are the shortest covalent bonds and therefore the strongest ones

Examiner Tip

Remember:

Single covalent bonds are the longest and weakest

Triple covalent bonds are the shortest and strongest



Your notes

Coordinate Bonds

Coordinate Bonds

What are coordinate bonds?

- In **simple covalent bonds** the two atoms involved share electrons
- Some molecules have a **lone** pair of electrons that can be donated to form a bond with an **electron-deficient** atom
 - An electron-deficient atom is an atom that has an **unfilled outer orbital**
- So **both electrons** are from the **same atom**
- This type of bonding is called **dative covalent bond** or **coordinate bond**
- An example of a dative bond is in an **ammonium ion**
 - The hydrogen ion, H^+ is **electron-deficient** and has space for two electrons in its shell
 - The nitrogen atom in ammonia has a lone pair of electrons which it can donate to the hydrogen ion to form a coordinate bond

Dative covalent bonding ammonium ion

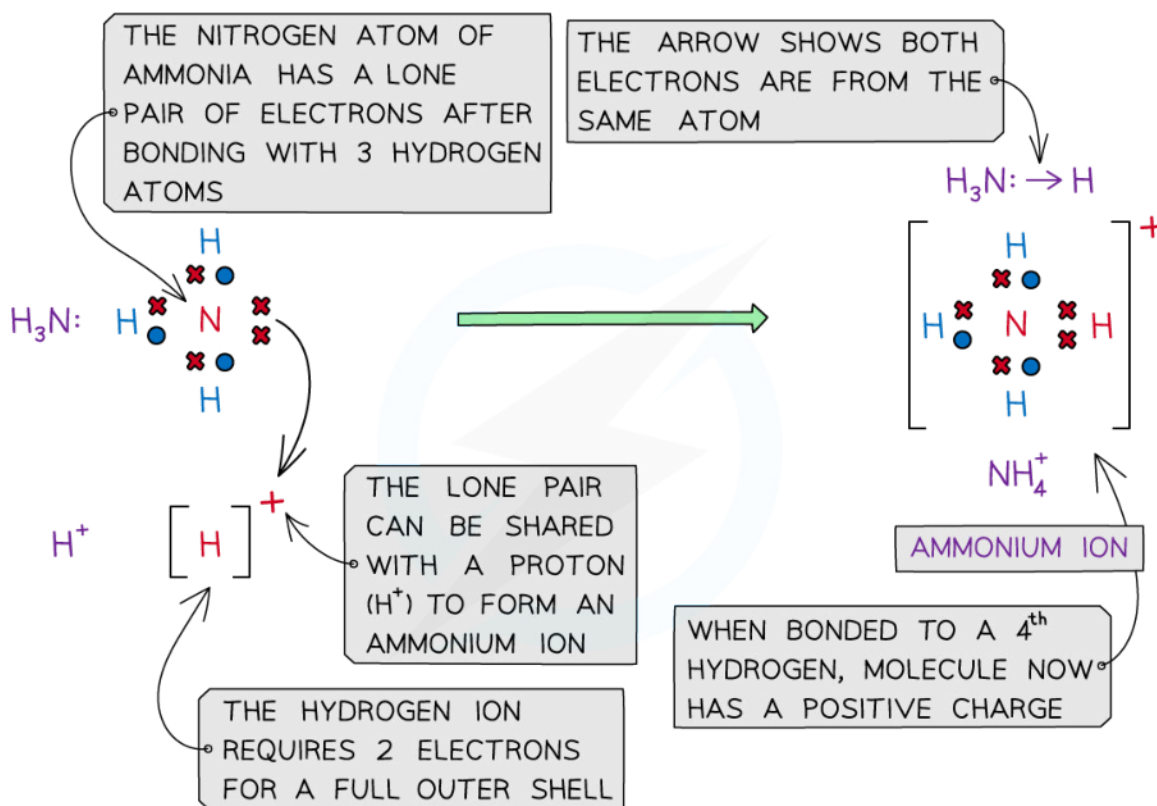

Copyright © Save My Exams. All Rights Reserved

Ammonia (NH_3) can donate a lone pair to an electron-deficient proton (H^+) to form a charged ammonium ion (NH_4^+)

- More examples of coordinate bonding can be found in the section on **Lewis Structures**

 **Examiner Tip**

Coordinate bonds are also referred to as coordination bonds or dative covalent bonds.



Your notes



Your notes

Shapes of Molecules

Shapes of Molecules

What is Valence Shell Electron Pair Repulsion Theory?

- When an atom forms a covalent bond with another atom, the electrons in the different bonds and the non-bonding electrons in the outer shell all behave as negatively charged clouds and repel each other
- In order to minimise this repulsion, all the outer shell electrons spread out as far apart in space as possible
- Molecular shapes and the angles between bonds can be predicted by the **valence shell electron pair repulsion theory** known by the abbreviation **VSEPR** theory
- VSEPR** theory consists of three basic rules:
 - All electron pairs and all lone pairs arrange themselves as far apart in space as is possible.
 - Lone pairs repel more strongly than bonding pairs.
 - Multiple bonds behave like single bonds
- These three rules can be used to predict the shape of any covalent molecule or ion, and the angles between the bonds
- The regions of negative cloud charge are known as **domains** and can have one, two or three pairs electrons

Two electron domains

- If there are two electron domains on the central atom, the angle between the bonds is 180°
- Molecules which adopt this shape are said to be **LINEAR**
- Examples of linear molecules include BeCl_2 , CO_2 , and $\text{HC}\equiv\text{CH}$

Diagram to show molecules with two electron domains

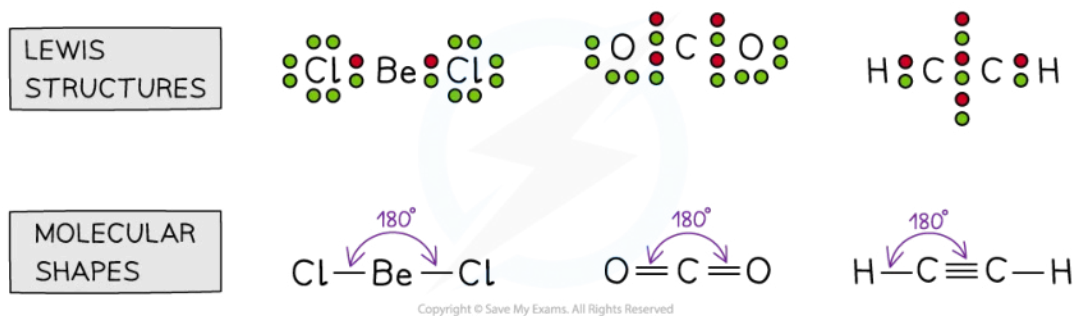

Beryllium chloride, carbon dioxide and ethyne all have two electron domains

Three electron domains

- If there are three electron domains on the central atom, the angle between the bonds is 120°
- Molecules which adopt this shape are said to be **TRIANGULAR PLANAR** or **TRIGONAL PLANAR**

- Examples of three electron domains which are all bonding pairs include BF_3 and CH_2CH_2 and CH_2O

Diagram to show molecules with three electron domains

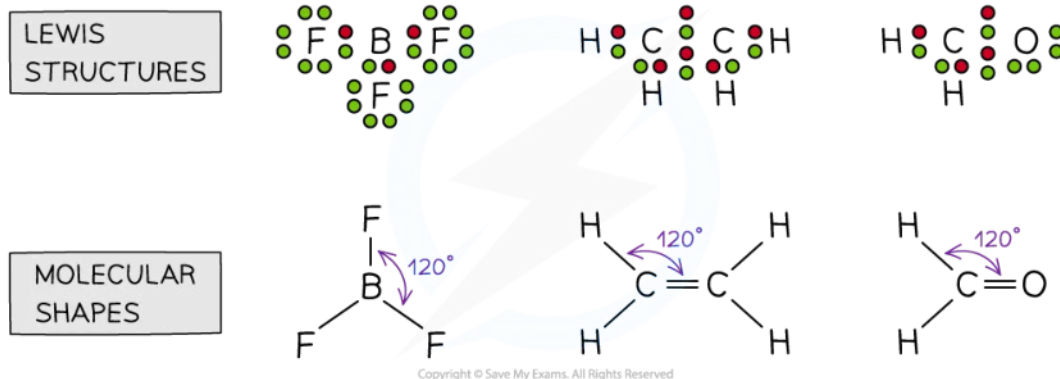

Boron trifluoride, ethene and methanal all have three electron domains

- If one of these electron domains is a lone pair, the bond angle is slightly less than 120° due to the stronger repulsion from lone pairs, forcing the bonding pairs closer together. E.g. SO_2
- The bond angle is approximately $\sim 118^\circ$

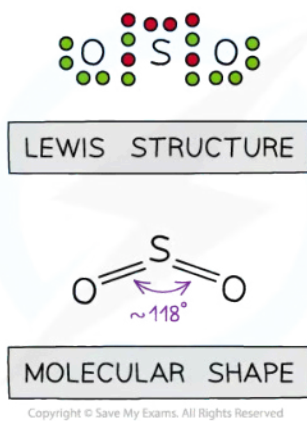

The shape of sulfur dioxide

- Sulfur dioxide is an example of a molecule that '**expands the octet**' as you will see there are 10 electrons around the sulfur atom which is possible for 3rd period elements and above
- This shape is no longer called triangular planar as the shape names are only based on the atoms present, this molecule is **BENT LINEAR**

Four electron domains



Your notes

- If there are four electron domains on the central atom, the angle between the bonds is approx 109° .
E.g. CH_4 , NH_4^+
- Molecules which adopt this shape are said to be **TETRAHEDRAL**



Your notes

Diagram to show molecules with four electron domains

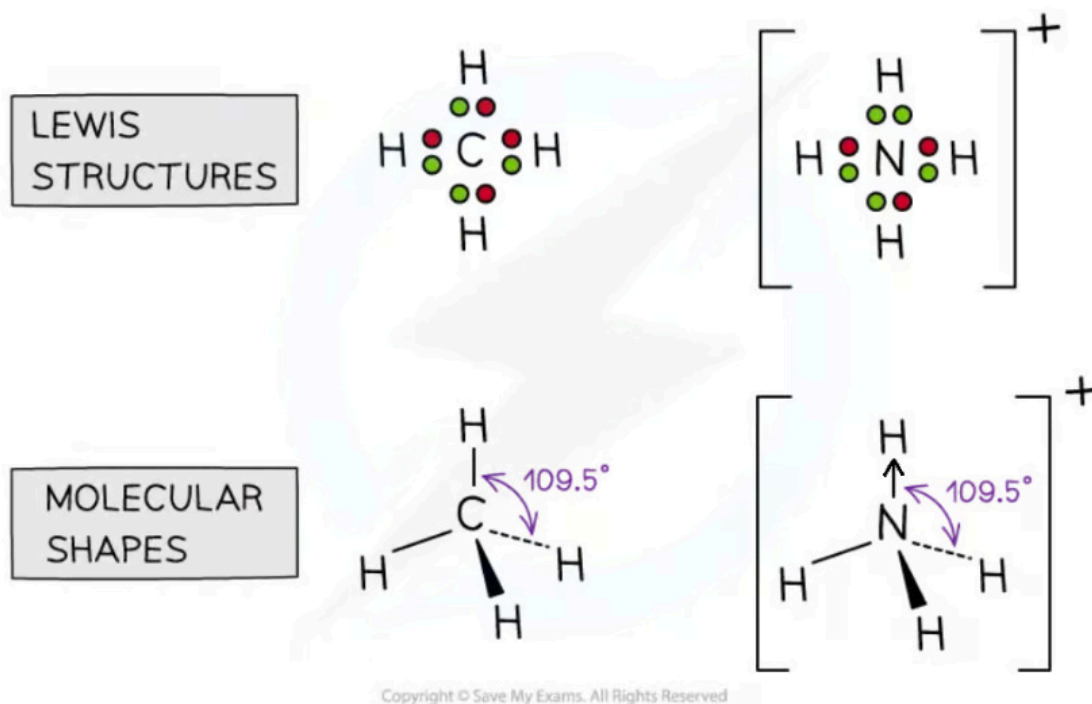

Methane and ammonium ions have four electron domains

- If one of the electron domains is a lone pair, the bond angle is slightly less than 109° , due to the extra lone pair repulsion which pushes the bonds closer together (approx 107°). E.g. NH_3 ,

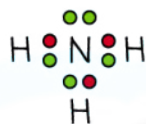

LEWIS STRUCTURE

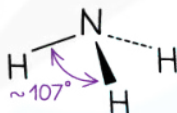

MOLECULAR SHAPE

Copyright © Save My Exams. All Rights Reserved

The shape of ammonia

- Molecules which adopt this shape are said to be **TRIANGULAR PYRAMIDAL** or **TRIGONAL PYRAMIDAL**
- If two of the electron domains are lone pairs, the bond angle is also slightly less than 109° , due to the extra lone pair repulsion (approx 104°). E.g. H_2O
- Molecules which adopt this shape are said to be **BENT** or **ANGULAR** or **BENT LINEAR** or **V-shaped** (when viewed upside down)

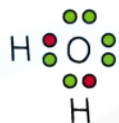

LEWIS STRUCTURE



MOLECULAR SHAPE

Copyright © Save My Exams. All Rights Reserved

The shape of water

- Lone pairs are pulled more closely to the central atoms so they exert a greater repulsive force than bonding pairs

Diagram to show repulsion between different electron pairs

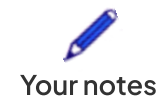
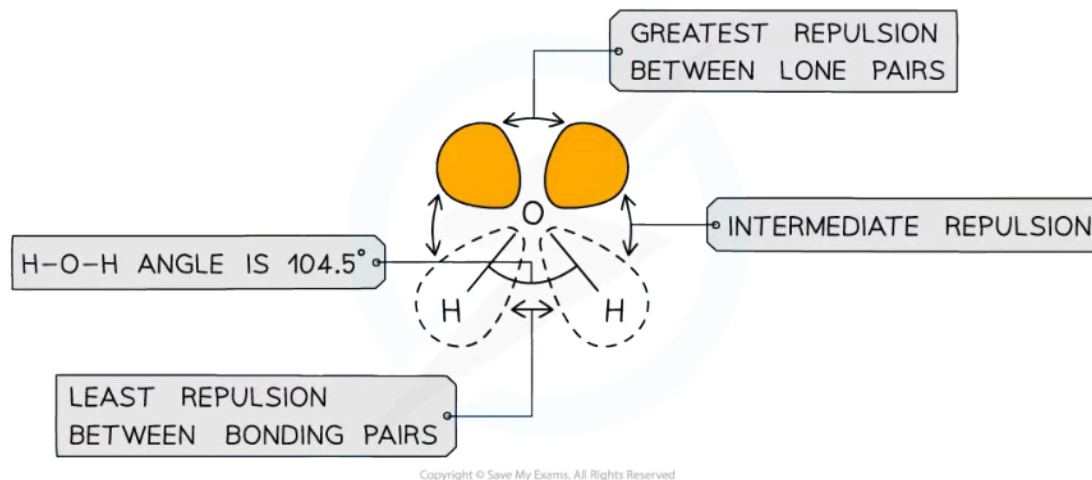

The order of electron pair repulsion is lone pairs > lone pair: bonding pair > bonding pairs

Summary table of electron domains and molecular shapes

- These are the domains and molecular geometries you need to know for Standard Level:

Bonding pairs	Lone pairs	Total pairs	Domain geometry	Molecular geometry	Bond angle
2	0	2	linear	linear	180°
3	0	3	trigonal planar	trigonal planar	120°
2	1	3	trigonal planar	bent linear	118°
4	0	4	tetrahedral	tetrahedral	109.5°
3	1	4	tetrahedral	trigonal pyramid	107°
2	2	4	tetrahedral	bent linear	104.5°

 **Examiner Tip**

Be careful to distinguish between molecular shape and electron domain shape as it can be easy to confuse the two. Sometimes they are the same as is the case of methane, but other times they can be different like ammonia which has a tetrahedral domain shape, but triangular pyramid molecular shape. Always draw the Lewis structure before you attempt to deduce the shape and bond angle as you could easily miss some lone pairs



Your notes



Your notes

Bond Polarity

Bond Polarity

What is electronegativity?

- **Electronegativity** refers to the ability of an atom to draw an electron pair towards itself in a covalent bond
- Different atoms have different electronegativities, shown by the **Pauling scale** below
- The higher the value, the more electronegative the element is

The Pauling Scale

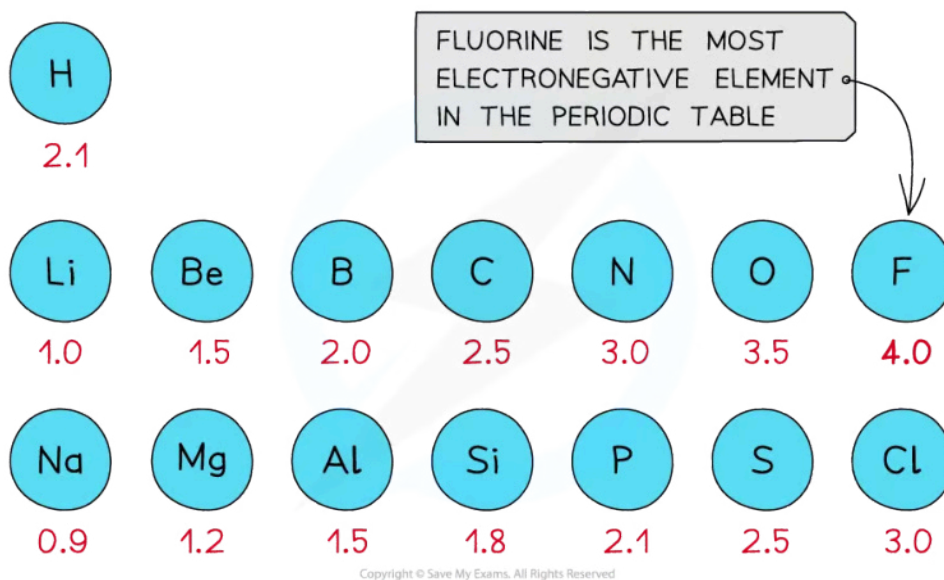

First three rows of the periodic table showing electronegativity values

- In **diatomic molecules** the electron density is shared equally between the two atoms
 - Eg. H_2 , O_2 and Cl_2
- Both atoms have the electronegativity value and have an **equal attraction** for the bonding pair of electrons leading to formation of a **covalent** bond
- The covalent bond is **nonpolar**

Diagram to show the electron distribution in a chlorine molecule

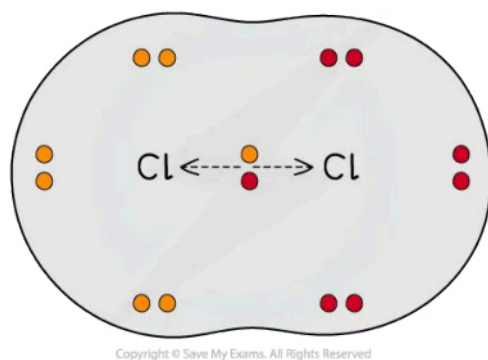

The two chlorine atoms have identical electronegativities so the bonding electrons are shared equally between the two atoms and the bond is nonpolar

What is meant by a polar bond?

- When two atoms in a covalent bond have **different electronegativities** the covalent bond is **polar** and the electrons will be drawn towards the **more electronegative** atom
- As a result of this:
 - The negative charge centre and positive charge centre do not **coincide** with each other
 - This means that the **electron distribution is asymmetric**
 - The **less electronegative** atom gets a partial charge of $\delta+$ (**delta positive**)
 - The **more electronegative** atom gets a partial charge of $\delta-$ (**delta negative**)
- The extent of polarity in a covalent bond varies, depending on how big a **difference** exists in the electronegativity values of the two bonded atoms
 - The bigger the difference in electronegativity, the higher the polarity of the covalent bond

Diagram to show the electron distribution in an HCl molecule

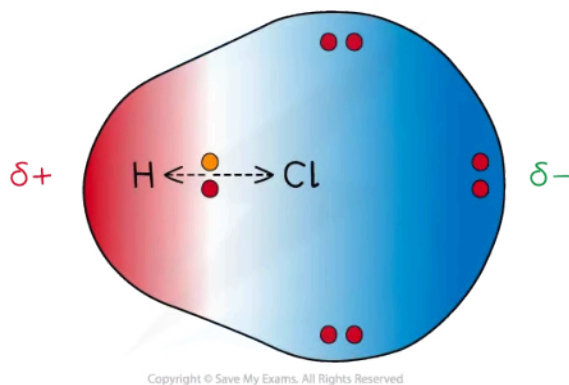

Cl has a greater electronegativity than H causing the electrons to be more attracted towards the Cl atom which becomes delta negative and the H delta positive



Your notes

What is a dipole?

- The **dipole moment** is a measure of how **polar** a bond is
- The **direction** of the dipole moment is shown by the following sign in which the **arrow** points to the **partially negatively charged end** of the dipole:



The sign shows the direction of the dipole moment and the arrow points to the delta negative end of the dipole

Worked example

The electronegativity values of four elements are given.

$$\text{C} = 2.6 \quad \text{N} = 3.0 \quad \text{O} = 3.4 \quad \text{F} = 4.0$$

What is the order of **increasing** polarity of the **bonds** in the following compounds?

- A. $\text{CO} < \text{OF}_2 < \text{NO} < \text{CF}_4$
- B. $\text{NO} < \text{OF}_2 < \text{CO} < \text{CF}_4$
- C. $\text{CF}_4 < \text{CO} < \text{OF}_2 < \text{NO}$
- D. $\text{CF}_4 < \text{NO} < \text{OF}_2 < \text{CO}$

Answer:

- The correct option is **B** because:
 - You have to calculate the difference in electronegativity for the bonds and then rank them from smallest to largest:

$$\text{NO} (3.4 - 3.0 = \mathbf{0.4})$$

$$\text{OF}_2 (4.0 - 3.4 = \mathbf{0.6})$$

$$\text{CO} (3.4 - 2.6 = \mathbf{0.8})$$

$$\text{CF}_4 (4.0 - 2.6 = \mathbf{1.4})$$



Your notes

Molecular Polarity

Molecular Polarity

- To determine whether a molecule with **more than two atoms** is polar, the following things have to be taken into consideration:
 - The polarity of each bond within the molecule
 - How the bonds are arranged in the molecule (i.e the geometry of the molecule)
- Some molecules have **polar bonds** but are overall not **polar** because the polar bonds in the molecule are arranged in such way that the individual dipole moments **cancel each other out**

A polar molecule

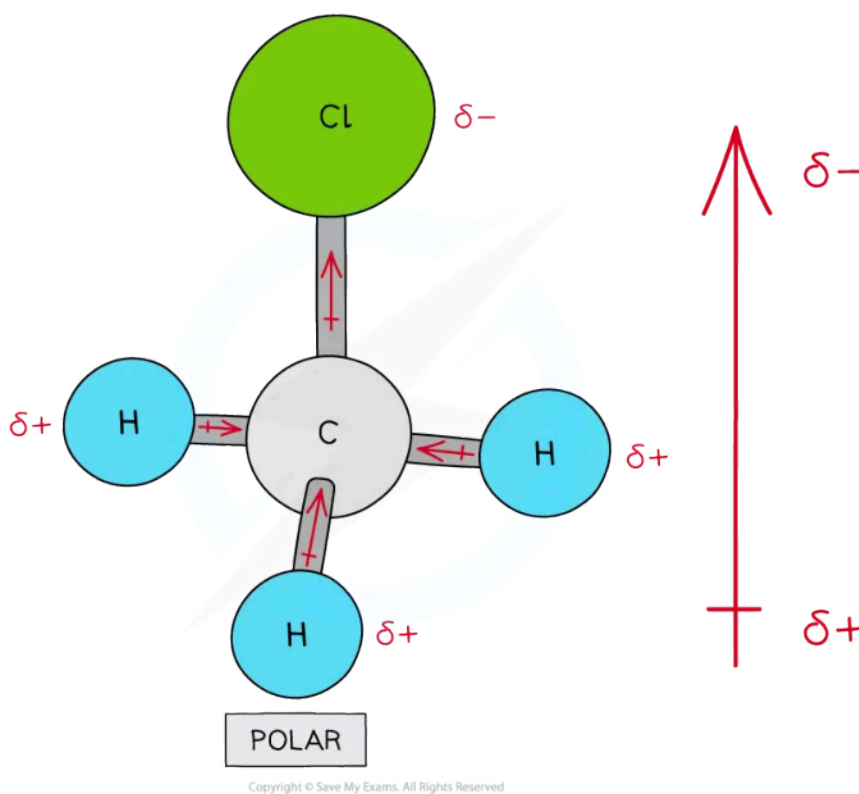

There are four polar covalent bonds in CH_3Cl which do not cancel each other out causing CH_3Cl to be a polar molecule; the overall dipole is towards the electronegative chlorine atom

A nonpolar molecule



Your notes

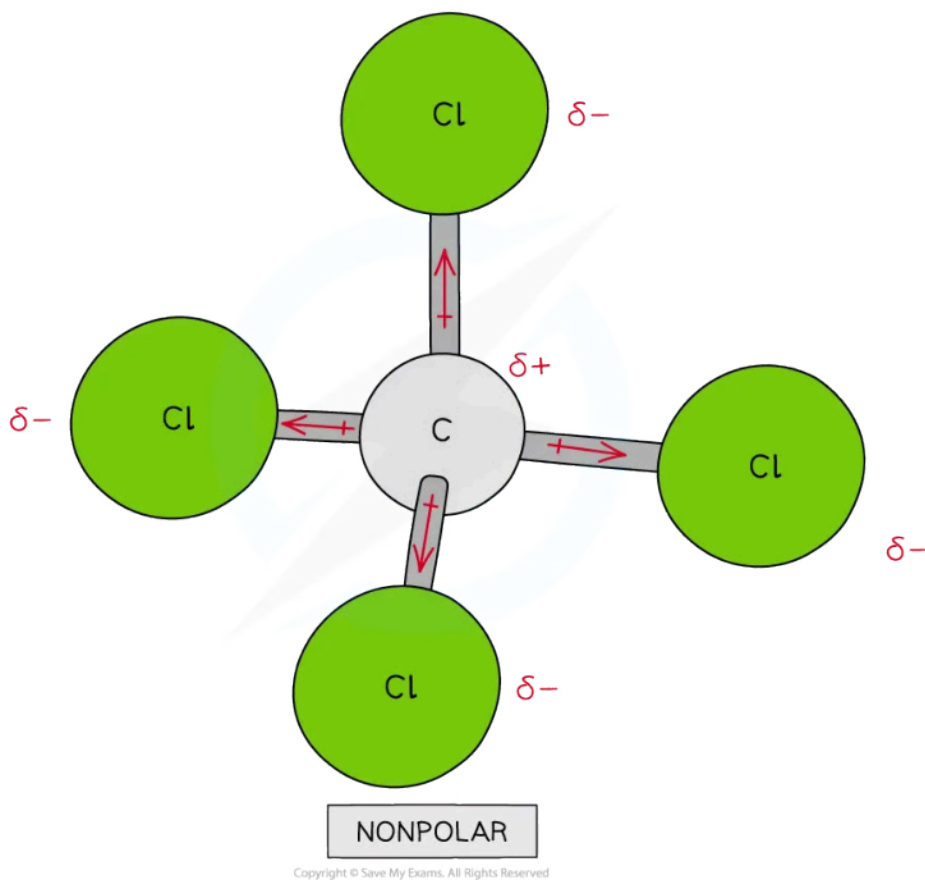

Though CCl_4 has four polar covalent bonds, the individual dipole moments cancel each other out causing CCl_4 to be a nonpolar molecule

 **Examiner Tip**

When the pulls of the atoms are not equal and opposite, there is a net pull so the molecule is polar.



Your notes

Giant Covalent Structures

Giant Covalent Structures

Covalent lattices

- **Covalent bonds** are bonds between nonmetals in which electrons are **shared** between the atoms
- In some cases, it is not possible to satisfy the bonding capacity of a substance in the form of a molecule; the bonds between atoms continue indefinitely, and a large lattice is formed. There are no individual molecules and covalent bonding exists between all adjacent atoms
- Such substances are called **giant covalent substances**, and the most important examples are C and SiO₂
- Graphite, diamond, buckminsterfullerene and graphene are allotropes of carbon

Diamond

- Diamond is a giant lattice of carbon atoms
- Each carbon is covalently bonded to four others in a tetrahedral arrangement with a bond angle of 109.5°
- The result is a giant lattice with strong bonds in all directions
- Diamond is the hardest substance known
 - For this reason it is used in drills and glass-cutting tools

Diagram to show the tetrahedral structure of diamond

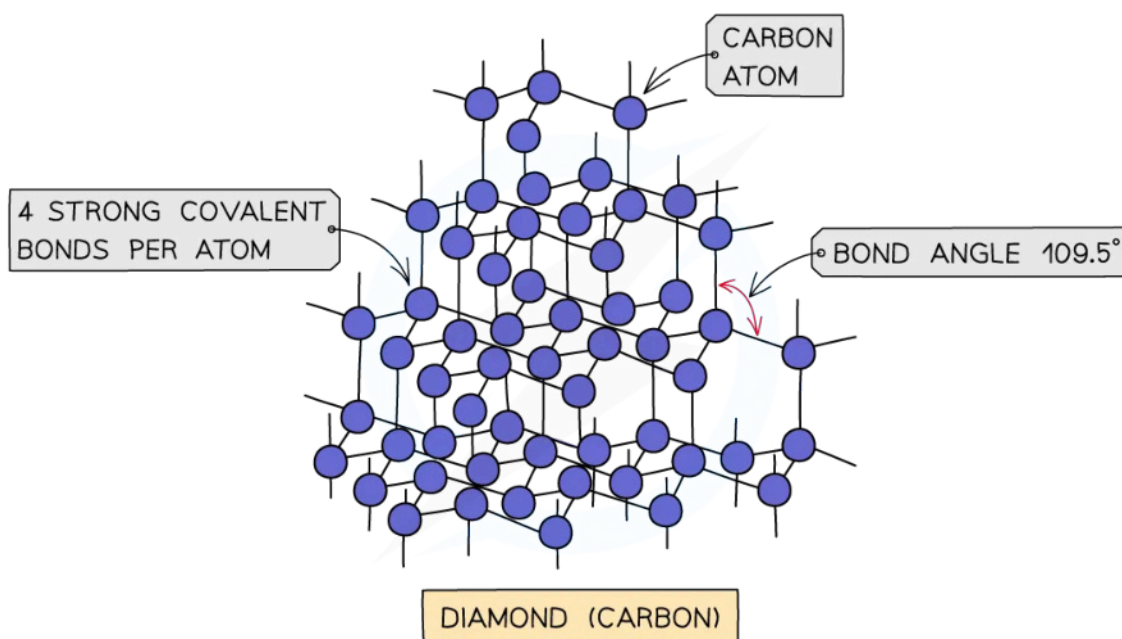

Copyright © Save My Exams. All Rights Reserved



Your notes

The structure of diamond

Graphite

- In graphite, each carbon atom is bonded to three others in a layered structure
- The layers are made of hexagons with a bond angle of 120°
- The spare electron is delocalised and occupies the space in between the layers
- All atoms in the same layer are held together by strong covalent bonds, and the different layers are held together by weak intermolecular forces

Diagram to show the layered structure of graphite

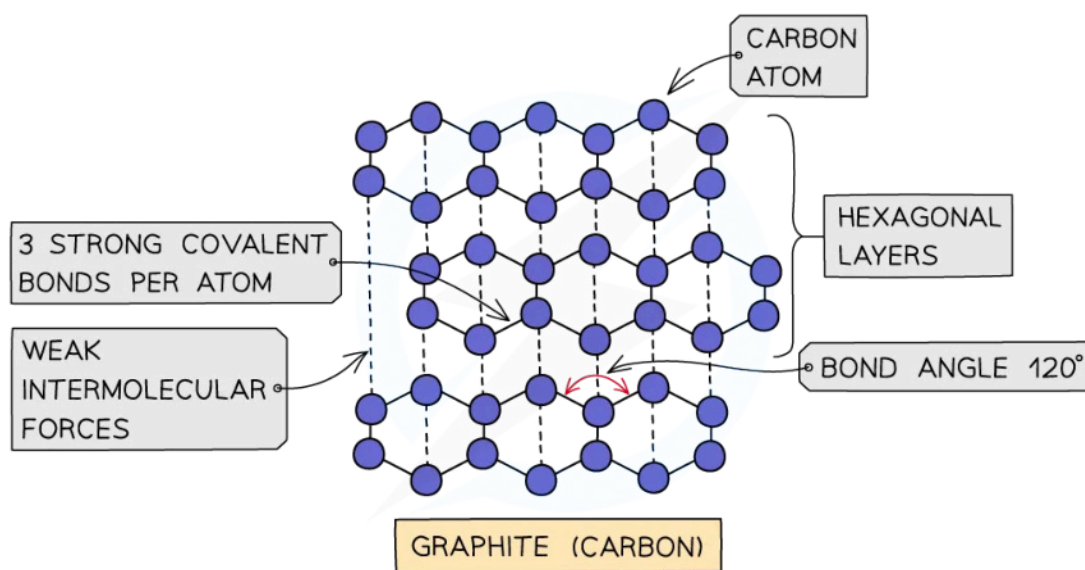

The structure of graphite

Buckminsterfullerene

- **Buckminsterfullerene** is one type of fullerene, named after Buckminster Fuller, the American architect who designed domes like the Epcot Centre in Florida
- It contains 60 carbon atoms, each of which is bonded to three others by single covalent bonds
- The fourth electron is delocalised so the electrons can migrate throughout the structure making the buckyball a semi-conductor
- It has exactly the same shape as a soccer ball, hence the nickname the football molecule

Diagram to show the interlocking hexagons and pentagons that make up the structure of Buckminsterfullerene

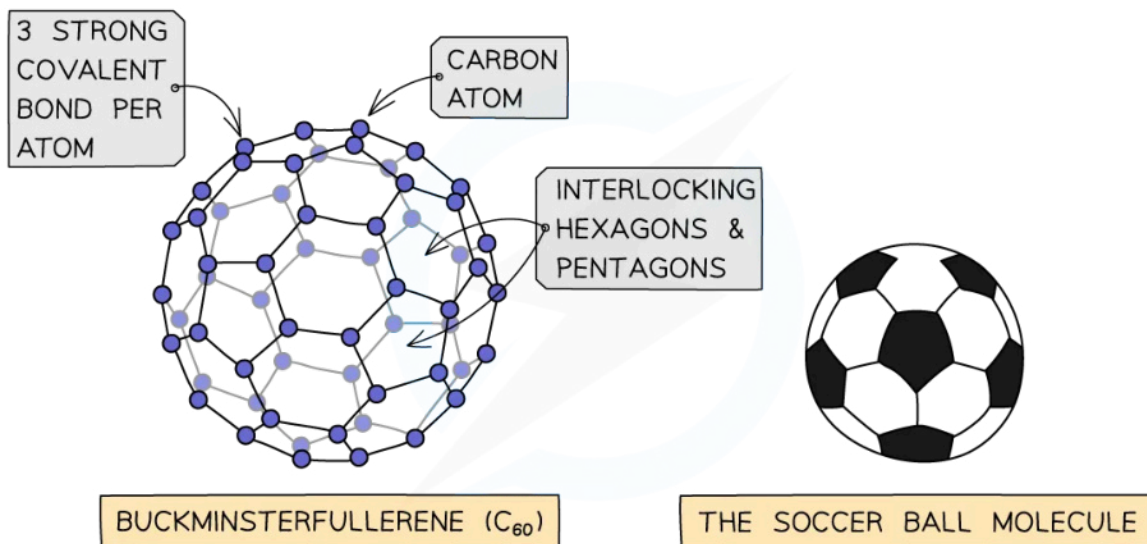

The structure of buckminsterfullerene

Graphene

- Some substances contain an infinite lattice of covalently bonded atoms in two dimensions only to form layers. Graphene is an example
- Graphene is made of a single layer of carbon atoms that are bonded together in a repeating pattern of hexagons
- Graphene is one million times thinner than paper; so thin that it is actually considered two dimensional

Diagram to show the two dimensional structure of graphene

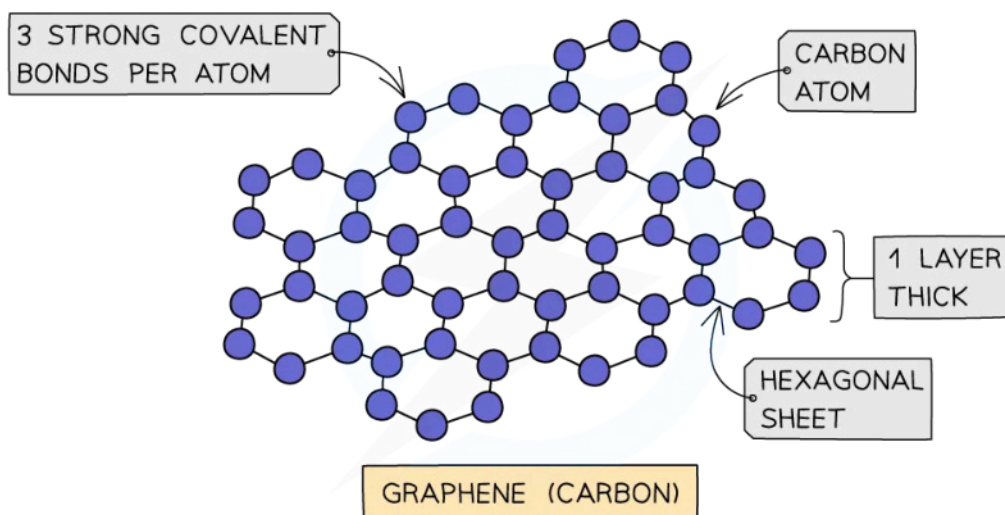



Your notes

The structure of graphene

Silicon

- The silicon atoms in silicon have a tetrahedral arrangement, just like that of the carbon atoms in diamond
- Each silicon atom is covalently bonded to four other silicon atoms
- Silicon has a giant lattice structure

Diagram to show the tetrahedral arrangement in silicon

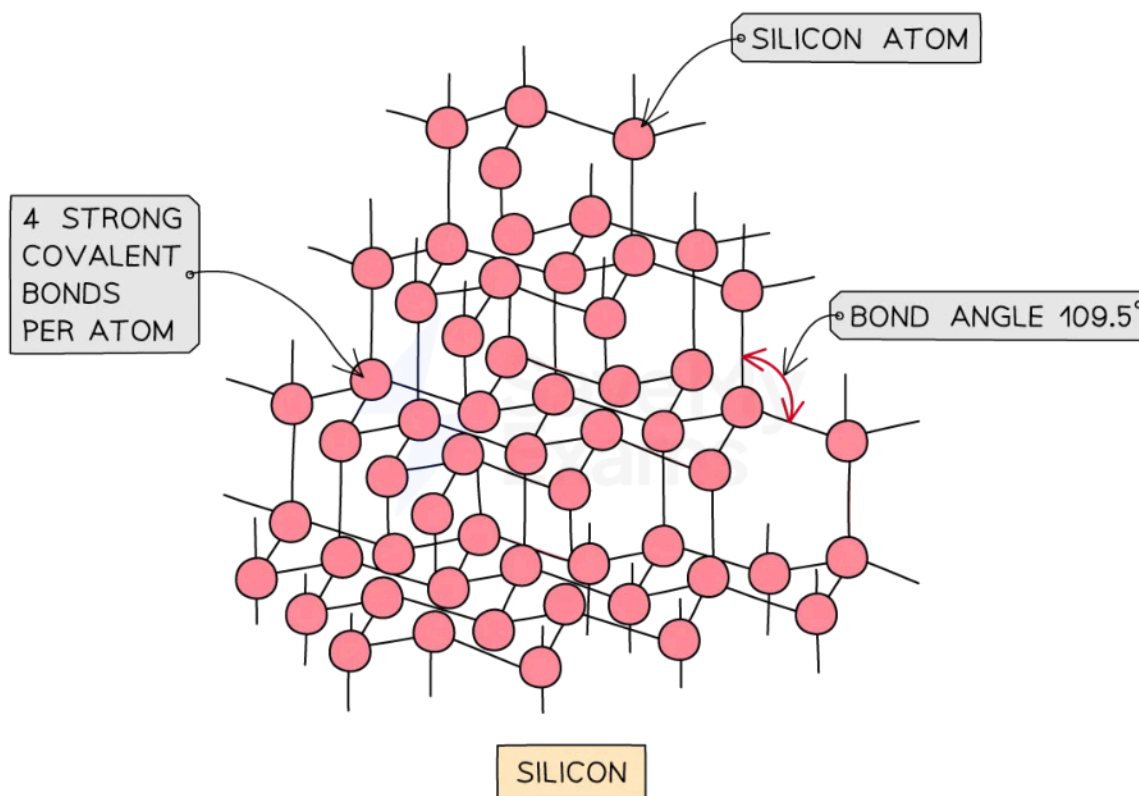

The structure of silicon

Silicon(IV) oxide

- Silicon(IV) oxide is also known as silicon dioxide, but you will be more familiar with it as the white stuff on beaches!
- Silicon(IV) oxide adopts the same structure as diamond - a giant structure made of tetrahedral units all bonded by strong covalent bonds
- Each silicon is shared by four oxygens and each oxygen is shared by two silicon atoms
- This gives an empirical formula of SiO_2

Diagram to show the tetrahedral units in silicon(IV) oxide

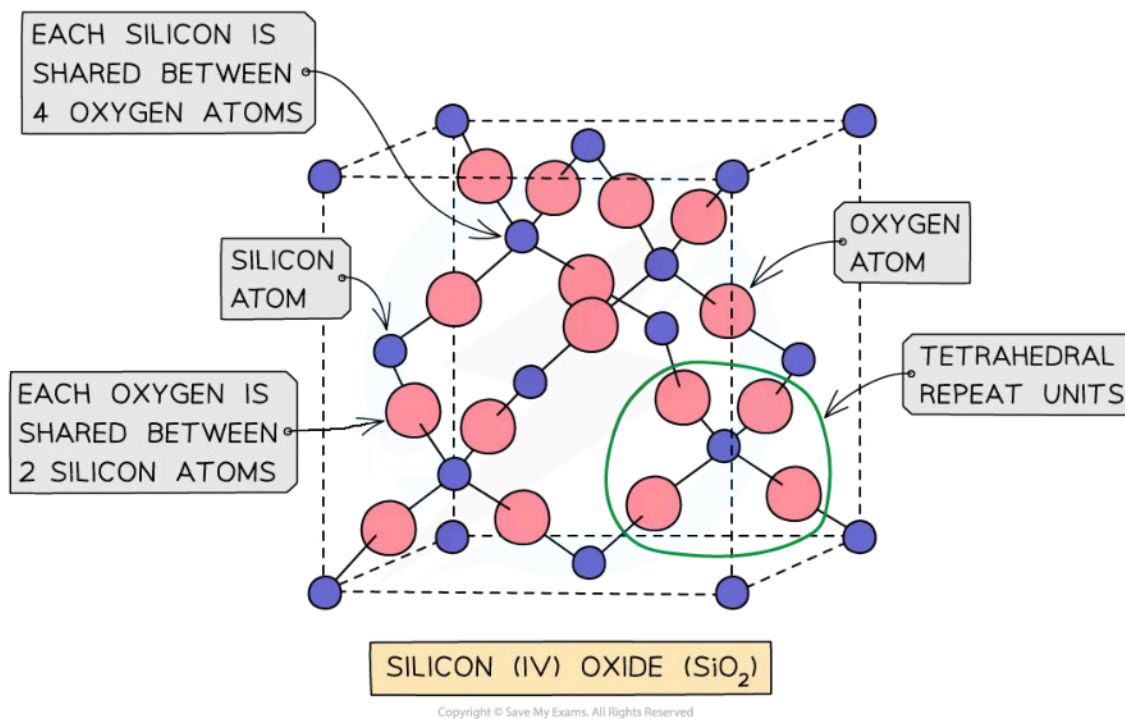

The structure of silicon dioxide

Properties of Giant Covalent Structures

- Different types of **structure** and **bonding** have different effects on the **physical properties** of substances such as their **melting** and **boiling points**, **electrical conductivity** and **solubility**
- **Giant covalent lattices** have very high **melting** and **boiling points**
 - These compounds have a large number of **covalent bonds** linking the whole structure
 - A lot of energy is required to break the lattice
- The compounds can be **hard** or **soft**
 - Graphite is **soft** as the forces between the carbon layers are weak
 - Diamond and silicon(IV) oxide are **hard** as it is difficult to break their 3D network of strong covalent bonds
 - Graphene is strong, flexible and transparent which it makes it potentially a very useful material
- Most compounds are insoluble with water
- Most compounds do not **conduct electricity** however some do
 - Graphite has **delocalised** electrons between the carbon layers which can move along the layers when a voltage is applied
 - Graphene is an excellent conductors of electricity due to the **delocalised** electrons
 - Buckminsterfullerene is a semi-conductor

- Diamond and silicon(IV) oxide do not conduct electricity as all four outer electrons on every carbon atom is involved in a **covalent bond** so there are no free electrons available

Characteristics of Giant Covalent Structures Table

	Diamond	Graphite	Graphene	Buckminsterfullerene	Silicon	Silicon dioxide
Melting and boiling point	Very high	Very high	Very high	Low	High	Very high
Appearance	Transparent crystal	Grey solid	Transparent	Black powder	Grey-white solid	Transparent crystals
Electrical conductivity	Non-conductor	Good	Very good	Poor	Poor	Non-conductor
Thermal conductivity	Good	Poor	Very good	Poor	Good	Good
Other properties	Hardest known natural substance	Soft and slippery	Thinnest and strongest material to exist	Light and strong	Good mechanical strength	Piezoelectric – produces electric charge from mechanical stress



Your notes

Examiner Tip

Although buckminsterfullerene is included in this section it is not classified as a giant structure as it has a fixed formula, C₆₀.

Intermolecular Forces



Your notes

Intermolecular Forces

- There are no covalent bonds between molecules in molecular covalent compounds. There are, however, forces of attraction between these molecules, and it is these which must be overcome when the substance is melted and boiled
- These forces are known as **intermolecular forces**
- There are three main types of **intermolecular forces**:
 - London (dispersion) forces
 - Dipole-dipole attraction
 - Hydrogen bonding

London (dispersion) forces

- The electrons in atoms are not static; they are in a state of constant motion
 - It is therefore likely that at any given time the distribution of electrons will not be exactly symmetrical - there is likely to be a slight surplus of electrons on one side of the atoms

Diagram to show how London (dispersion) forces arise

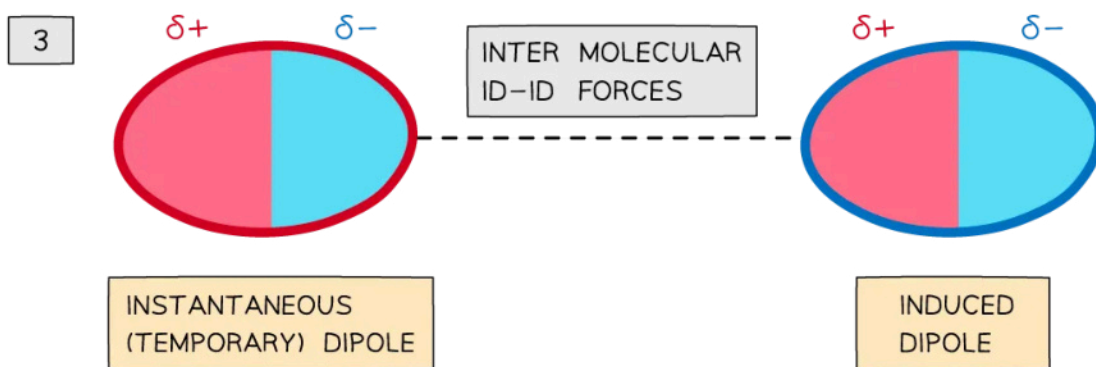
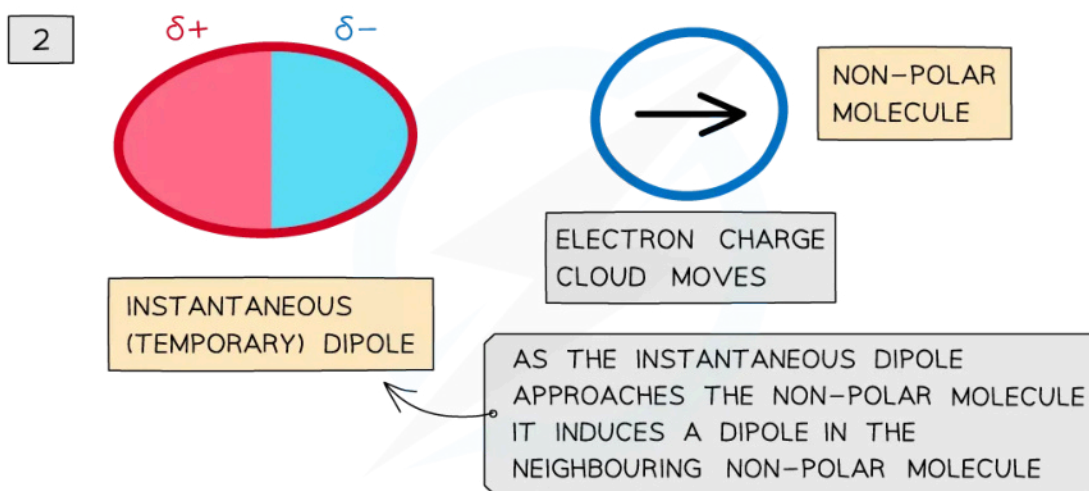
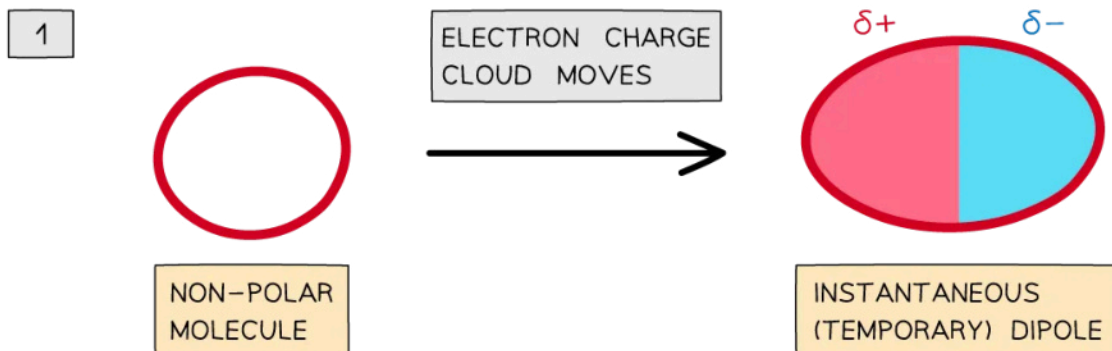

Copyright © Save My Exams. All Rights Reserved

London (Dispersion) forces

- This is known as a **temporary dipole**
 - It lasts for a very short time as the electrons are constantly moving

- **Temporary dipoles** are constantly appearing and disappearing
- Consider now an adjacent atom. The electrons on this atom are repelled by the negative part of the dipole and attracted to the positive part and move accordingly
- This is a **temporary induced dipole**
 - There is a resulting attraction between the two atoms, and this known as **London (dispersion) forces**, after the German chemist, Fritz London
- **London (dispersion) forces** are present between all atoms and molecules, although they can be very weak
 - They are the reason all compounds can be liquefied and solidified
 - **London (dispersion) forces** tend to have strengths between 1 kJmol^{-1} and 50 kJmol^{-1} .
- The strength of the **London (dispersion) forces** in between molecules depends on two factors:
 - the number of electrons in the molecule
 - Surface area of the molecules

Number of electrons

- The greater the number of electrons in a molecule, the greater the likelihood of a distortion and thus the greater the frequency and magnitude of the temporary dipoles
- The dispersion forces between the molecules are stronger and the melting and boiling points are larger
- The enthalpies of vaporisation and boiling points of the noble gases illustrate this factor:

Graph to show the effect of number of electrons on enthalpy of vaporisation and boiling point



Your notes



Your notes

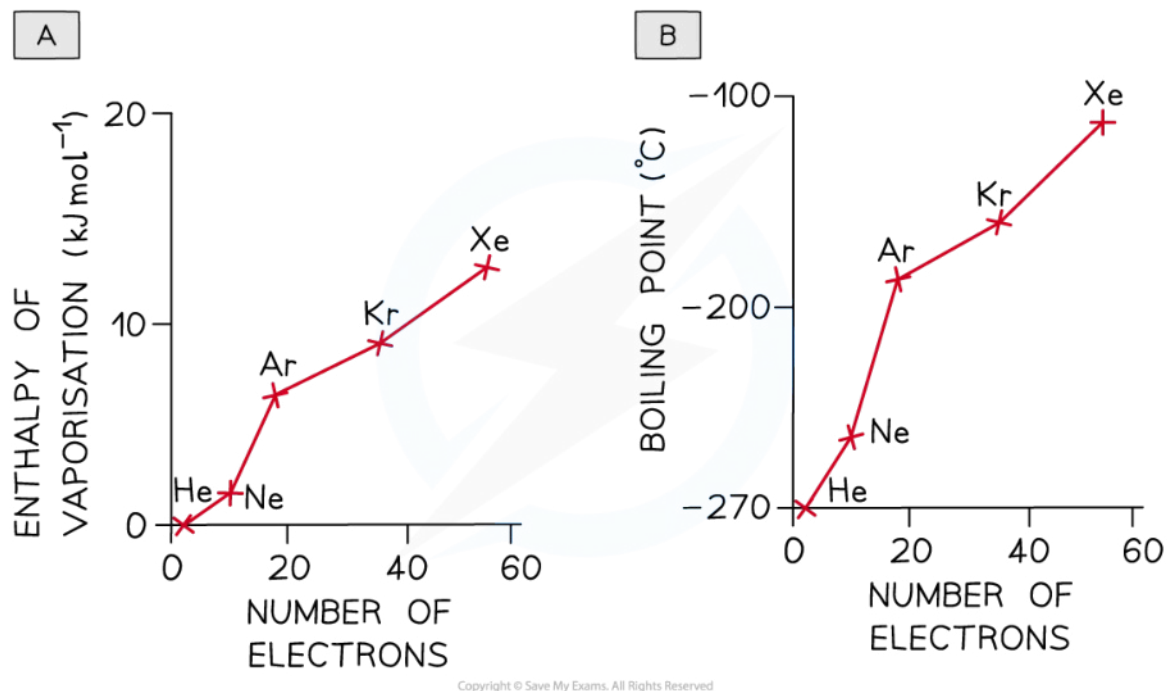

As the number of electrons increases more energy is needed to overcome the forces of attraction between the noble gases atoms

Surface area

- The larger the surface area of a molecule, the more contact it will have with adjacent molecules
- The greater its ability to induce a dipole in an adjacent molecule, the greater the **London (dispersion) forces** and the higher the melting and boiling points
- This point can be illustrated by comparing different isomers containing the same number of electrons:

Diagram to show the effect of surface area on intermolecular forces

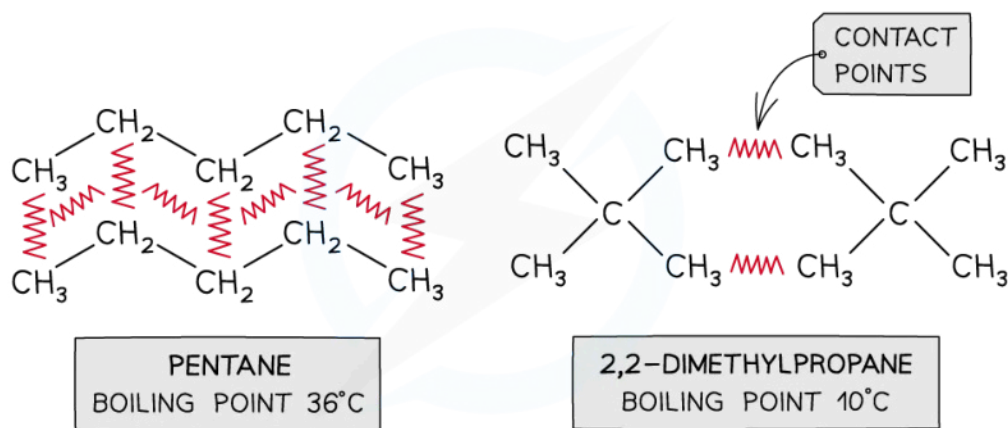

Copyright © Save My Exams. All Rights Reserved

Boiling points of molecules with the same numbers of electrons but different surface areas

Dipole-dipole attractions

- Temporary dipoles exist in all molecules, but in some molecules there is also a **permanent dipole**
- In addition to the **London (dispersion) forces** caused by temporary dipoles, molecules with permanent dipoles are also attracted to each other by **permanent dipole-dipole bonding**

Diagram to show permanent dipole-dipole interactions

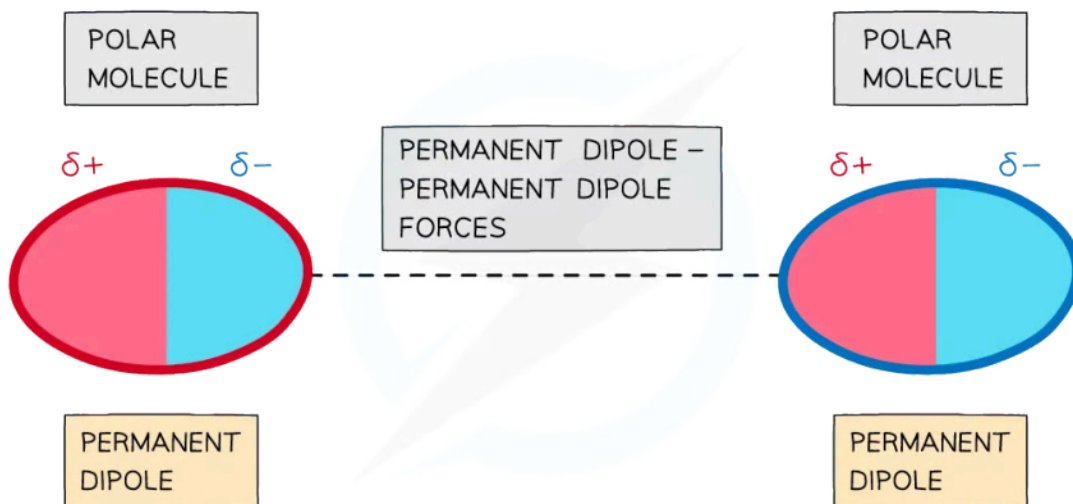

Copyright © Save My Exams. All Rights Reserved

The delta negative end of one polar molecule will be attracted towards the delta positive end of a neighbouring polar molecule

- This is an attraction between a **permanent dipole** on one molecule and a **permanent dipole** on another.
- **Dipole-dipole bonding** usually results in the boiling points of the compounds being slightly higher than expected from temporary dipoles alone
 - it slightly increases the strength of the intermolecular attractions
- The effect of **dipole-dipole bonding** can be seen by comparing the melting and boiling points of different substances which should have **London (dispersion) forces** of similar strength

Comparing butane and propanone

- For small molecules with **the same number of electrons**, **dipole-dipole attractions** are **stronger** than **dispersion forces**
 - Butane and propanone have the same number of electrons
 - Butane is a nonpolar molecule and will have only dispersion forces
 - Propanone is a polar molecule and will have dipole-dipole attractions and dispersion forces
 - Therefore, more energy is required to break the intermolecular forces between propanone molecules than between butane molecules
 - The result is that propanone has a higher boiling point than butane

Diagram to show the structures of butane and propanone

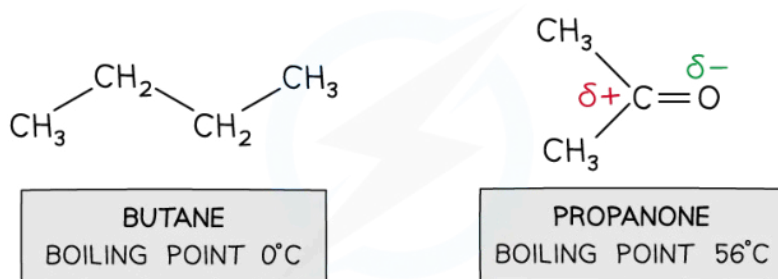

Copyright © Save My Exams. All Rights Reserved

Comparing substances with permanent and temporary dipoles in smaller molecules with an equal number of electrons

Dipole-induced dipole attraction

- Some mixtures might contain both polar and nonpolar molecules, for example HCl and Cl₂
- The permanent dipole of a polar molecule can cause a temporary separation of charge on a non-polar molecule
- This force is called dipole-induced dipole attraction
- This force acts in addition to the London dispersion forces that occur between nonpolar molecules and the dipole-dipole forces between polar molecules

Diagram to show dipole-induced dipole attraction

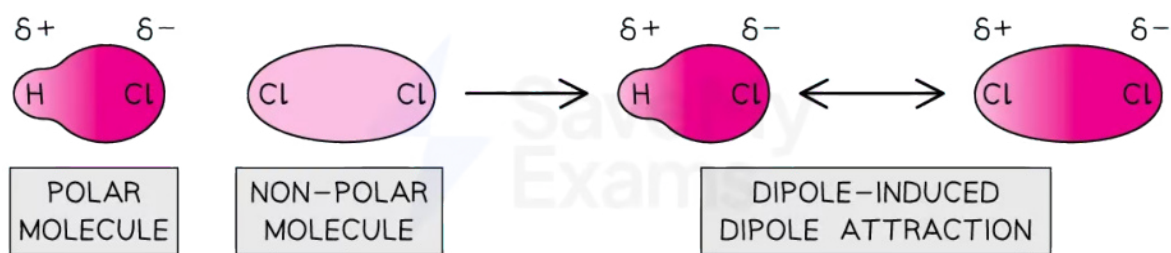

Copyright © Save My Exams. All Rights Reserved

The polar HCl molecule causes a separation of charge on the nonpolar chlorine molecule

Hydrogen bonding

- Hydrogen bonding is the **strongest** type of **intermolecular force**
 - Hydrogen bonding is a special type of **permanent dipole – permanent dipole** bonding
- For hydrogen bonding to take place the following is needed:
 - A species which has an **O** or **N** or **F** (very **electronegative**) atom with an available **lone pair** of electrons
 - A hydrogen attached to the **O, N** or **F**
- When hydrogen is covalently bonded to an **electronegative** atom, such as **O, N** or **F**, the bond becomes very highly **polarised**
- The H becomes so **δ^+** charged that it can form a bond with the **lone pair** of an **O, N** or **F** atom in another molecule

Diagram to show polarisation of the H–O/N/F bond

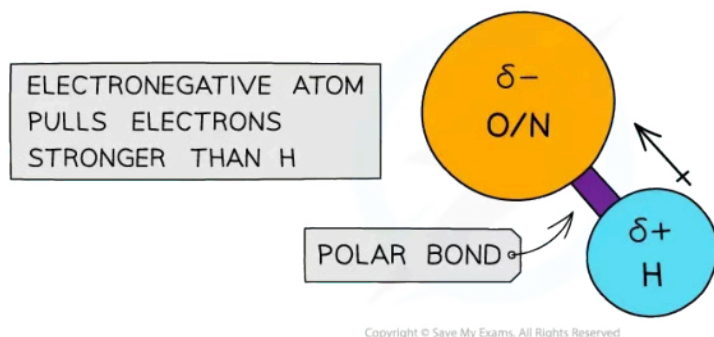

Copyright © Save My Exams. All Rights Reserved

The electronegative atoms O or N have a stronger pull on the electrons in the covalent bond with hydrogen, causing the bond to become polarised

- Hydrogen bonds are represented by dots or dashes between H and the N/O/F element
- The number of hydrogen bonds depends on:
 - The number of hydrogen atoms attached to O, N or F in the molecule
 - The number of **lone pairs** on the O, N or F

Diagram to show hydrogen bonding in ammonia

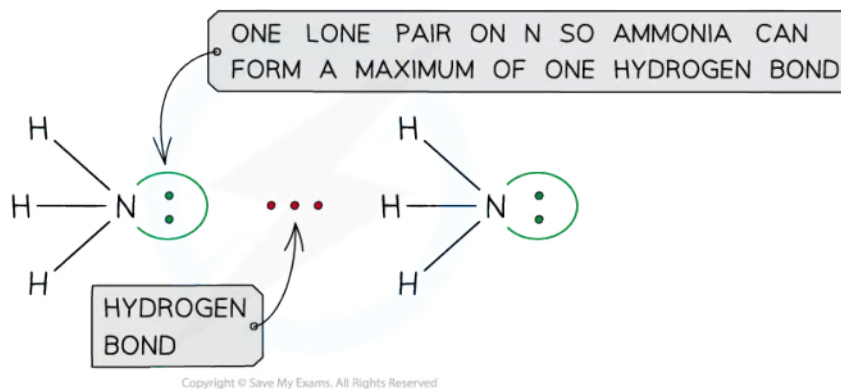

Ammonia can form a maximum of one hydrogen bond per molecule

Diagram to show hydrogen bonding in water

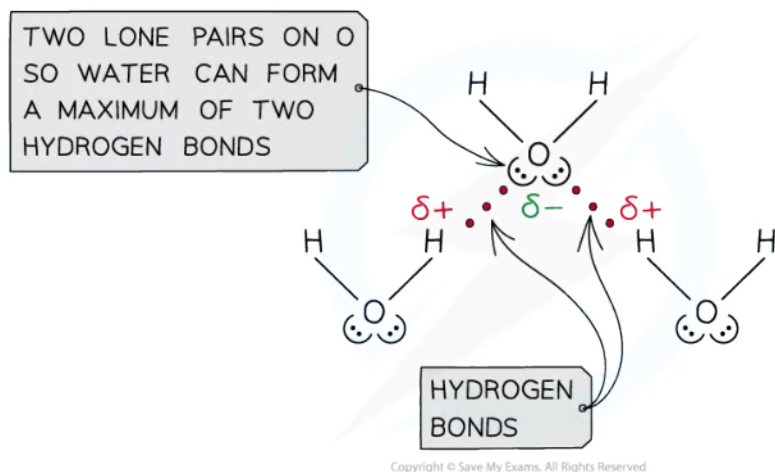

Water can form a maximum of two hydrogen bonds per molecule

Van der Waals' forces

- The term Van der Waal's forces is used to include:
 - London dispersion forces
 - Dipole-induced dipole attractions
 - Dipole-dipole attractions
- These forces occur between molecules (intermolecularly), as well within a molecule (intramolecularly)

Diagram to show the difference between intermolecular and intramolecular forces

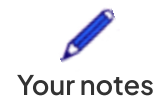
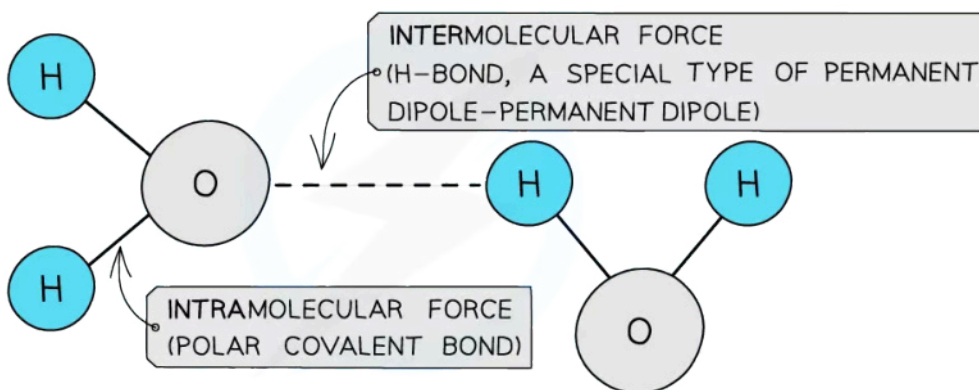

The polar covalent bonds between O and H atoms are intramolecular forces and the permanent dipole – permanent dipole forces between the molecules are intermolecular forces

 **Examiner Tip**

The term “London (dispersion) forces” refers to instantaneous induced dipole induced dipole forces that exist between any atoms or groups of atoms and should be used for non-polar species.



Your notes

Physical Properties of Covalent Substances

Physical Properties of Covalent Substances

- The physical properties of **molecular covalent compounds** are largely influenced by their **intermolecular forces**
- If you know the type of **intermolecular forces** present you can predict the physical properties like **melting** and **boiling point**, **solubility**, and **conductivity**

Melting and boiling point

- When covalent molecular substances change state you are overcoming the **intermolecular forces**
- The stronger the forces the more energy need to break the attraction
- **Intermolecular forces** are much weaker than covalent bonds, so many covalent substances are liquid or gases at room temperature
- Substance with a low melting and boiling point are said to be very **volatile**
- The strength of the intermolecular forces increases with
 - the **size** of the molecule
 - the increase in the **polarity** of the molecule
 - Drawing the structure of the molecule helps identify and rank molecules according to boiling point as the following example shows

Worked example

Place these three molecules in the correct order from lowest to highest boiling point and explain your reasoning:

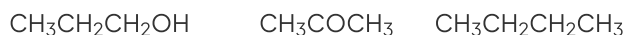

Answer:

- **Step 1:** The first thing to do is find the approximate relative molecular mass:

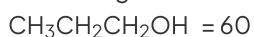

This tells you the molecules are approximately the same size so the dispersion forces will be similar

- **Step 2:** Draw the structures of the molecules and identify the intermolecular forces present

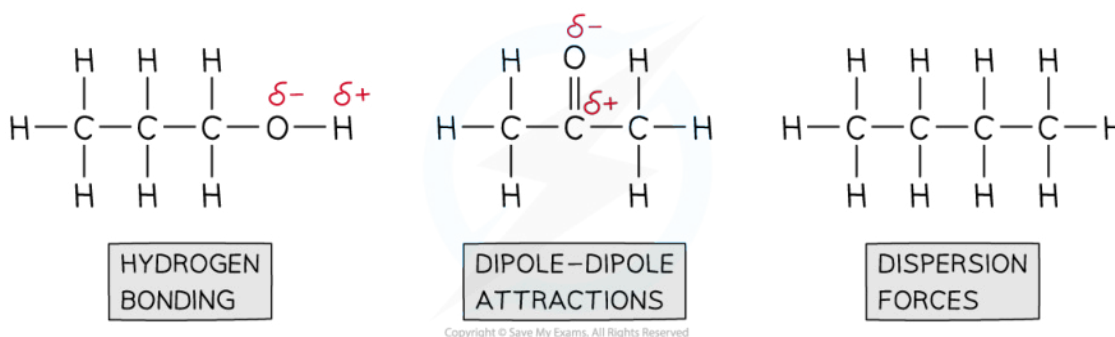

So, the order of boiling from lowest to highest is:



Solubility

- The general principle is that 'like dissolves like' so non-polar substances mostly dissolve in non-polar solvents, like hydrocarbons and they form dispersion forces between the solvent and the solute
- Polar covalent substances generally dissolve in polar solvents as a result of dipole-dipole interactions or the formation of hydrogen bonds between the solute and the solvent
- A good example of this is seen in organic molecules such as alcohols and water:

Diagram to show the hydrogen bonding between ethanol and water

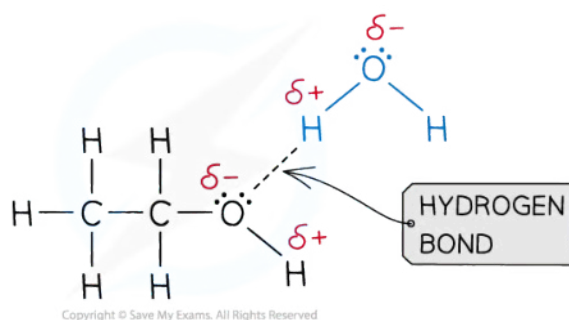

A hydrogen bond forms between oxygen atom on the ethanol and the hydrogen atom of the water

- As covalent molecules become larger their solubility can decrease as the polar part of the molecule is only a smaller part of the overall structure
 - This effect is seen in alcohols for example where ethanol, C_2H_5OH , is readily soluble but hexanol, $C_6H_{13}OH$, is not
- Polar covalent substances are unable to dissolve well in non-polar solvents as their dipole-dipole attractions are unable to interact well with the solvent
- Giant covalent substances generally don't dissolve in any solvents as the energy needed to overcome the strong covalent bonds in the lattice structures is too great

Conductivity

- As covalent substances do not contain any freely moving charged particles they are unable to conduct electricity in either the solid or liquid state
- However, under certain conditions some polar covalent molecules can ionise and will conduct electricity
- Some giant covalent structures are capable of conducting electricity due to delocalised electrons but they are exceptions to the general rule

Comparing the Properties of Covalent Compounds Table

	Non-polar covalent substances	Polar covalent substances	Giant covalent substances	Ionic substances
Melting and boiling point	Low	Low	Very high	Very high
Volatility	Highest	High	Low	Low
Solubility in polar solvents	Insoluble	Some solubility depending on	Insoluble	Soluble



Your notes

		molecular size		
Solubility in non-polar solvents	Soluble	Some solubility depending on molecular size	None	Insoluble
Electrical conductivity	None	None	None – except graphite, graphene	Only when molten or aqueous

Worked example

Compound **X** has the following properties:

Melting point	Electrical conductivity	
1450°C	solid	molten
	poor	poor

What is the most probable structure of **X**?

- A. Network covalent
- B. Polar covalent molecule
- C. Ionic lattice
- D. Metallic lattice

Answer:

- The correct option is **A** because:
 - A high melting point is characteristic of a giant structure, which could be metallic, ionic or covalent
 - The poor conductivity as a liquid and solid would match a giant covalent or network covalent structure



Your notes

Chromatography

Chromatography

What is chromatography?

- Chromatography is a separation technique that enables the separation of mixtures and includes:
 - paper chromatography
 - thin-layer chromatography (TLC)
- These chromatography techniques make use of the principle that components in a mixture when dissolved in a fluid (**mobile phase**), will flow through another material (**stationary phase**) at varying rates
- The rate of separation depends upon how the components in the mixture interact with the stationary phase (their **retention**) and how soluble they are in the mobile phase
- Therefore the rate of separation depends on the intermolecular forces present

For more information on performing chromatography and other separation techniques, see our revision notes on [separating mixtures](#)

Examiner Tip

- Column chromatography (CC) and gas chromatography (GC), sometimes called gas-liquid chromatography (GLC), are other chromatographic techniques you may see in other resources
- They also work on the same principles as paper chromatography and TLC but with different stationary and mobile phases.
 - These are beyond the scope of this specification.

What is paper chromatography?

- In paper chromatography, the mobile phase is a **solvent**, and the stationary phase is the **chromatography paper**
- A **pencil line** is drawn on chromatography paper, this is the **baseline** (or origin), and spots of the sample are placed on it
 - Pencil is used for this as ink would run into the chromatogram along with the samples
- The paper is then lowered into the solvent container, making sure that the pencil line sits **above** the level of the solvent so the samples don't wash into the solvent container
- The solvent travels up the paper by capillary action, taking the sample with it
- As the solvent moves up the paper, the components in the mixture are dissolved to different extents depending on their **solubility**, so will travel with the solvent at different rates
 - The extent of solubility depends on the **intermolecular forces** present
- The paper contains cellulose fibres which have hydroxyl (OH) groups along their structure
- Substances in the mixture that can form **hydrogen bonds** with the OH groups will be more attracted to the stationary phase than those which form weaker intermolecular forces
 - This attraction to the stationary phase also affects the rate of separation

- Once the solvent front almost reaches the top of the paper, the paper is removed from the solvent and the solvent front is marked on the paper
- The separated components will appear as distinct spots on the paper

Paper chromatography

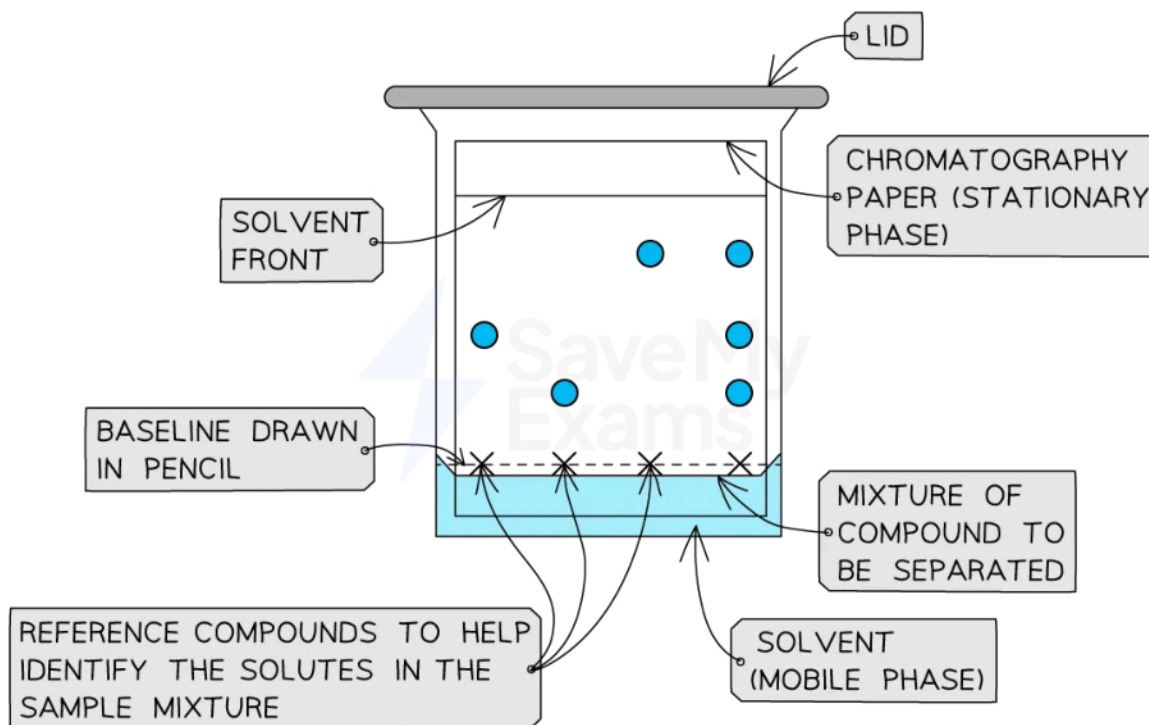

A dot of the sample is placed on the baseline and allowed to separate as the mobile phase flows through the stationary phase; the reference compound/s will also move with the solvent and are used to identify the components in the mixture.

Examiner Tip

- If the sample does not travel with the solvent, it is because it is insoluble in that solvent
- An alternative solvent should be used
- Sometimes a number of solvents need to be trialled in order to find a suitable one in which the components of the sample are separated sufficiently

What is thin layer chromatography (TLC)?

- TLC works in a similar way to paper chromatography but has a different stationary phase
- The **stationary phase** is a thin layer of an inert substance (e.g. **silica** or **alumina**) supported on a flat, unreactive surface (e.g. **glass**)
- The **mobile phase**, like paper chromatography, is a **solvent**



Your notes

- Silica and alumina contain OH groups so can form hydrogen bonds with components in the sample
- The components are **adsorbed** onto the surface of the stationary phase
- Depending on the strength of interactions with the stationary phase, the separated components will travel particular distances through the plate

What are retardation factors (R_f) values?

- The extent of separation of the component molecules in the investigated sample depends on their solubility in the mobile phase and the extent of adhesion to the stationary phase
- The R_f value is used to quantify the distance a particular component travels relative to the solvent front
- R_f values for compounds are calculated using measurements from the paper chromatogram or TLC plate and can be calculated using the R_f equation:

$$R_f = \frac{\text{distance travelled by component}}{\text{distance travelled by solvent}}$$

- These values can be used alongside other analytical data to deduce the composition of mixtures

Calculation of R_f values

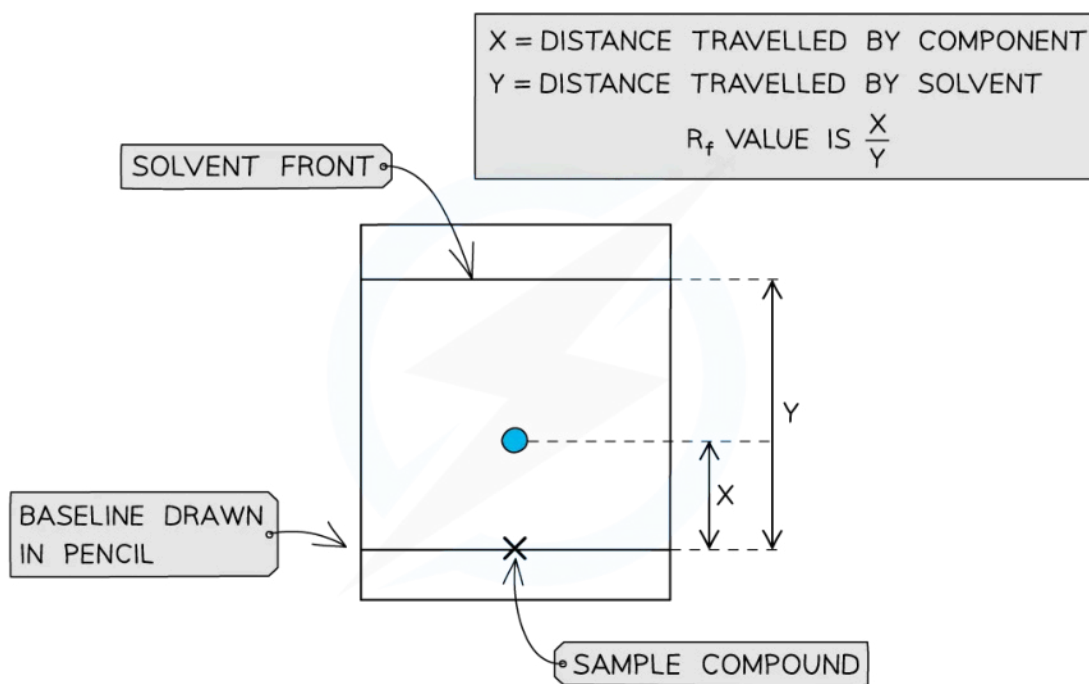

R_f values can be calculated by taking 2 measurements from a chromatogram

Examiner Tip

- R_f values are quoted as decimals and have no units as they are a ratio of distances
 - When you divide two lengths measured in the same unit, those units cancel out, leaving you with a unitless number.
- R_f values will always be less than 1 as the component cannot travel further than the solvent front!



Your notes



Your notes

Resonance Structures (HL)

Resonance Structures

- The delocalisation of electrons can explain the structures of some species that don't seem to fit with a Lewis formula
- Delocalised electrons are electrons in a molecule, ion or solid metal that are not associated with a single atom or one covalent bond
- The Lewis diagram for the nitrate (V) ion gives a molecule with a double and two single bonds
- There are three possible Lewis formulas
- These structures are called resonance structures
- However, studies of the electron density and bond length in the nitrate (V) ion indicate all the bonds are equal in length and the electron density is spread evenly between the three oxygen atoms
 - The bond length is intermediate between a single and a double bond
 - The actual structure is something in between the resonance structures and is known as a resonance hybrid

Resonance structures of the nitrate (V) ion

- To determine the Lewis formula of the nitrate (V) ion first count the number of valence electrons and then add one electron for the negative charge on the ion

$$\text{Number of valence electrons} = N + 3O + 1$$

$$= 5 + (3 \times 6) + 1 = \mathbf{24 \text{ electrons}}$$

- Three structures are possible, consisting of a double bond and two singles:

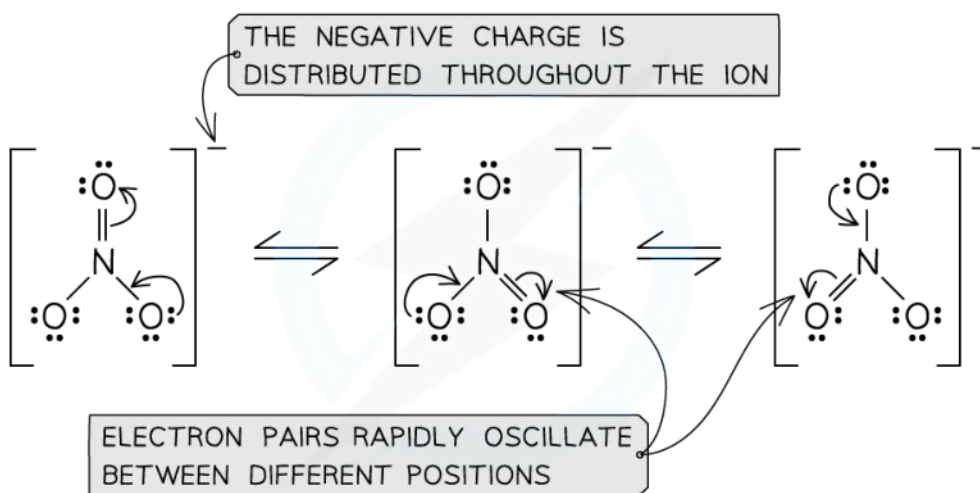

Copyright © Save My Exams. All Rights Reserved

Resonance structures in the nitrate ion

- Dotted lines are used to show the position of the delocalised electrons

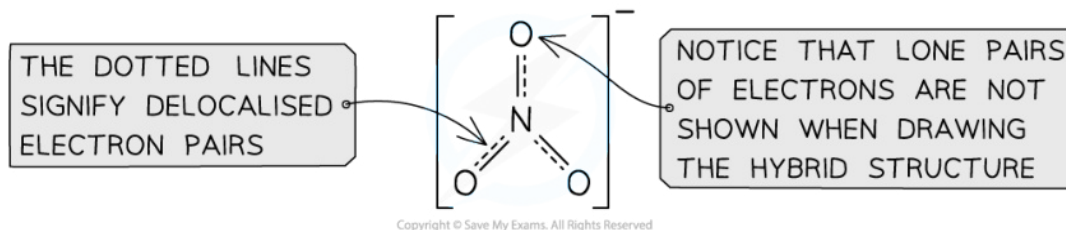

Resonance hybrid nitrate (V) ion

- The criteria for forming resonance hybrids structures is that molecules must have a double bond (π bond) that is capable of migrating from one part of a molecule to another
- This usually arises when there are adjacent atoms with equal electronegativity and lone pairs of electrons that can re-arrange themselves and allow the double bonds to be in different positions
- Other examples that you should know about are the carbonate ion, benzene, ozone and the carboxylate anion

Resonance Hybrids Table

- Below are some other resonance structures and hybrids that you should know:

Species	Lewis Resonance Formulas	Resonance Hybrid
Carbonate ion, CO_3^{2-}		
Benzene, C_6H_6		
Ozone, O_3		

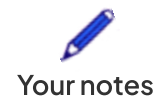

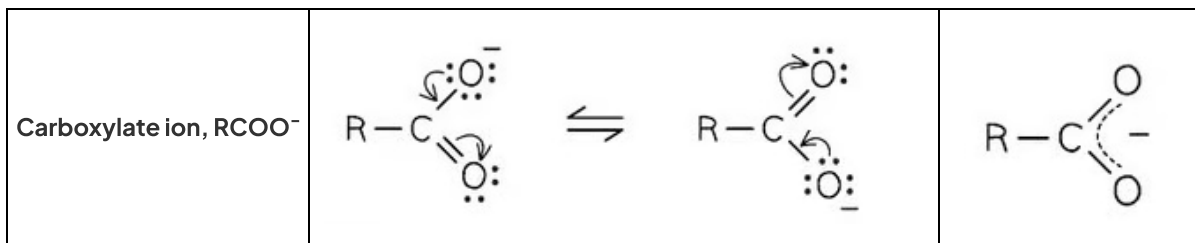

Your notes



Your notes

Benzene (HL)

Benzene

Structure of Benzene

- The structure of benzene was determined many years ago, by a chemist called Kekulé
- The structure consists of 6 carbon atoms in a hexagonal ring, with alternating single and double carbon-carbon bonds
 - This suggests that benzene should react in the same way that an unsaturated alkene does
 - However, this is not the case

The structure of benzene

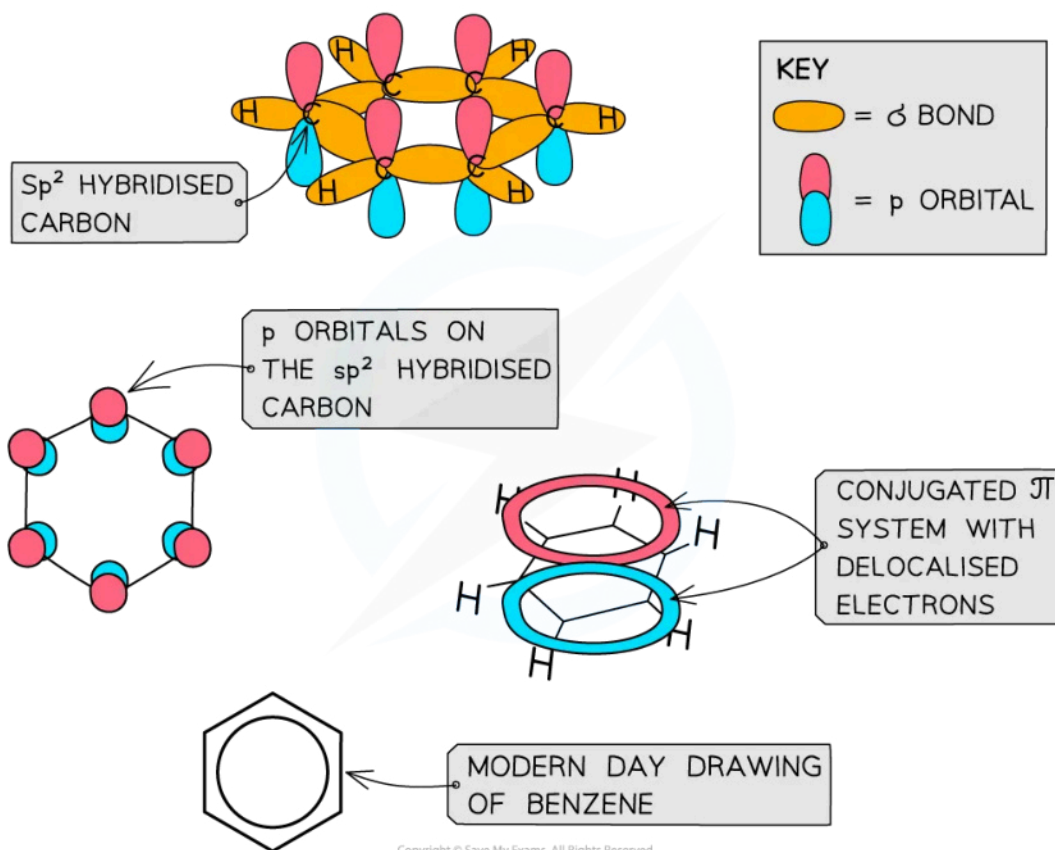

Like other aromatic compounds, benzene has a planar structure due to the sp^2 hybridisation of carbon atoms and the conjugated π system in the ring

- Each carbon atom in the ring forms three σ bonds using the sp^2 orbitals
- The remaining **p orbitals** overlap laterally with p orbitals of neighbouring carbon atoms to form a π system



Your notes

- This extensive sideways overlap of p orbitals results in the electrons being delocalised and able to freely spread over the entire ring causing a π system
 - The π system is made up of two ring-shaped clouds of electron density - one above the plane and one below it
- Benzene and other aromatic compounds are **regular** and **planar** compounds with bond angles of 120°
- The delocalisation of electrons means that all of the carbon-carbon bonds in these compounds are identical and have both **single** and **double** bond character
- The bonds all being the same length is evidence for the delocalised ring structure of benzene

Evidence for delocalisation

- This evidence of the bonding in benzene is provided by data from:
 - Enthalpy changes of hydrogenation
 - Carbon-carbon bond lengths from X-ray diffraction
 - Saturation tests
 - Infrared spectroscopy

Enthalpy changes of hydrogenation

- Hydrogenation of cyclohexene
 - Each molecule has one C=C double bond
 - The enthalpy change for the reaction of cyclohexene is -120 kJ mol^{-1}

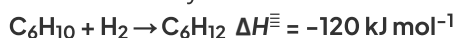

- Hydrogenation of benzene
 - The Kekulé structure of benzene as cyclohexa-1,3,5-triene has three double C=C bonds:

Structural formula of benzene

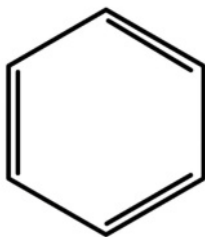

The structural formula of benzene shows the alternating single and double bonds

- It would be expected that the enthalpy change for the hydrogenation of this structure would be three times the enthalpy change for the one C=C bond in cyclohexene

$$\text{C}_6\text{H}_6 + 3\text{H}_2 \rightarrow \text{C}_6\text{H}_{12} \quad \Delta H^\ominus = 3 \times -120 \text{ kJ mol}^{-1} = -360 \text{ kJ mol}^{-1}$$
- When benzene is reacted with hydrogen, the enthalpy change obtained is actually far less exothermic, $\Delta H^\ominus = -208 \text{ kJ mol}^{-1}$
 - This means that 152 kJ mol^{-1} less energy is produced than expected
 - Therefore, the actual structure of benzene is more stable than the theoretical Kekulé model



Carbon-carbon bond lengths

- Cyclohexene contains two different carbon-carbon bonds
 - The single carbon-carbon bond (C-C) has a bond length of 154 pm
 - The double carbon-carbon bond (C=C) has a bond length of 134 pm
- The Kekulé structure of benzene as cyclohexa-1,3,5-triene has three single C-C and three double C=C bonds
 - It would be expected that benzene would have an equal mixture of bonds with lengths of 134 pm and 154 pm

Comparing carbon-carbon bond lengths

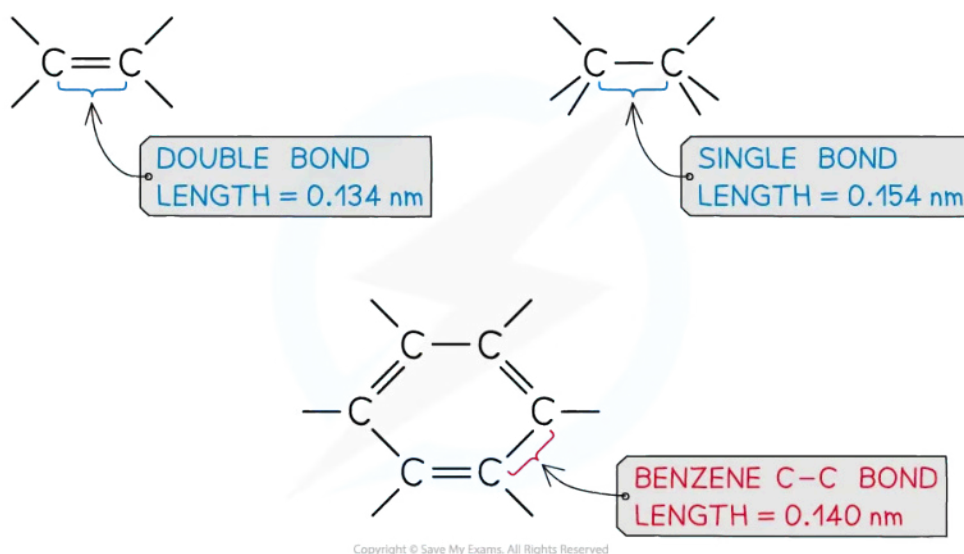

The bond lengths observed in benzene are intermediate of single and double carbon-carbon bond lengths

- All of the carbon-carbon bond lengths are 140 pm suggesting that they are all the same and also intermediate of the single C-C and double C=C bonds

Saturation tests

- Cyclohexene will decolourise bromine water as an electrophilic addition reaction takes place
- The Kekulé structure of benzene as cyclohexa-1,3,5-triene has three double C=C bonds
 - It would, therefore, be expected that benzene would easily decolourise bromine water
- Benzene does not decolourise bromine water suggesting that there are no double C=C bonds

Infrared spectroscopy

- Cyclohexene shows a peak in the range of $1620 - 1680 \text{ cm}^{-1}$ for the double C=C bond within its structure
- The Kekulé structure of benzene as cyclohexa-1,3,5-triene has three double C=C bonds
 - It would, therefore, be expected to also show a peak at $1620 - 1680 \text{ cm}^{-1}$ for the double C=C bonds

- Benzene does not show a peak in this range for the double C=C bonds, instead, peaks are seen at around 1450, 1500 and 1580 cm^{-1} which are characteristic of double C=C bonds in arenes



Your notes



Your notes

Expansion of the Octet (HL)

Expansion of the Octet

Expansion of the octet

- Elements in period 3 and above have the possibility of having more than eight electrons in their valence shell
- This is because there is a d-subshell present which can accommodate additional pairs of electrons
- This is known as the **expansion of the octet**
- The concept explains why structures such as PCl_5 and SF_6 exist, which have 5 and 6 bonding pairs of electrons respectively, around the central atom

Five electron pairs

Phosphorus pentachloride, PCl_5

- An example of a molecule with five bonding electron pairs is phosphorus pentachloride, PCl_5
- The total number of valence electrons is $= \text{P} + 5\text{Cl} = 5 + (5 \times 7) = 40$
- The number of bonding pairs is 5, which accounts for 10 electrons
- The remaining 30 electrons would be 15 lone pairs, so that each Cl has 3 lone pairs
- The completed Lewis formula looks like this:

Lewis formula of PCl_5



The octet of the central phosphorous atom has been expanded to hold 10 electrons

Sulfur tetrafluoride, SF_4

- The total number of valence electrons is $= \text{S} + 4\text{F} = 6 + (4 \times 7) = 34$
- The number of bonding pairs is 4, which accounts for 8 electrons
- The remaining 26 electrons would be 13 lone pairs
- Fluorine cannot expand the octet so each fluorine would accommodate 3 lone pairs, accounting for 24 electrons, leaving 1 lone pair on the sulfur (sulfur has expanded the octet)
- The completed Lewis formula looks like this:

Lewis formula of SF_4



The octet of the central sulfur atom has been expanded to hold 10 electrons

Chlorine trifluoride, ClF₃

- The total number of valence electrons is = Cl + 3F = 7 + (3 × 7) = 28
- The number of bonding pairs is 3, which accounts for 6 electrons
- The remaining 22 electrons would be 11 lone pairs
- Fluorine cannot expand the octet so each fluorine would accommodate 3 lone pairs, accounting for 18 electrons, leaving 2 lone pairs on the chlorine
- The completed Lewis formula looks like this:

Lewis formula of ClF₃



The octet of the central chlorine atom has been expanded to hold 10 electrons

Triiodide ion, I₃⁻

- The total number of valence electrons is = 3I + the negative charge = (3 × 7) + 1 = 22
- The number of bonding pairs is 2, which accounts for 4 electrons
- The remaining 18 electrons would be 9 lone pairs
- Iodine would accommodate 3 lone pairs, accounting for 12 electrons, leaving 3 lone pairs on the central iodine
- The completed Lewis formula looks like this:

Lewis formula of I₃⁻



The octet of the central iodine atom has been expanded to hold 10 electrons

Six electron pairs

Sulfur hexafluoride, SF₆



Your notes

- An example of a molecule with six bonding electron pairs is sulfur hexafluoride, SF₆
- The total number of valence electrons is = S + 6F = 6 + (6 x 7) = 48
- The number of bonding pairs is 6, which accounts for 12 electrons
- The remaining 36 electrons would be 18 lone pairs, so that each F has 3 lone pairs, accounting for all electrons and no lone pairs
- The completed Lewis formula looks like this:

Lewis formula of SF₆



Copyright © Save My Exams. All Rights Reserved

The octet of the central sulfur atom has been expanded to hold 12 electrons

Bromine pentafluoride, BrF₅

- The total number of valence electrons is = Br + 5F = 7 + (5 x 7) = 42
- The number of bonding pairs is 5, which accounts for 10 electrons
- The remaining 32 electrons would be 16 lone pairs
- Fluorine cannot expand the octet so each fluorine would accommodate 3 lone pairs, accounting for 30 electrons, leaving 1 lone pair on the bromine
- The completed Lewis formula looks like this:

Lewis formula of BrF₅



Copyright © Save My Exams. All Rights Reserved

The octet of the central bromine atom has been expanded to hold 12 electrons

Xenon tetrafluoride, XeF₄

- The total number of valence electrons is = Xe + 4F = 8 + (4 x 7) = 36
- The number of bonding pairs is 4, which accounts for 8 electrons
- The remaining 28 electrons would be 14 lone pairs
- Each fluorine would accommodate 3 lone pairs, accounting for 24 electrons, leaving 2 lone pairs on the xenon
- The completed Lewis formula looks like this:

Lewis formula of XeF₄



The octet of the central xenon atom has been expanded to hold 12 electrons

Revisiting Valence Shell Electron Pair Repulsion Theory (VSEPR)

- Molecular shapes and the angles between bonds can be predicted using the three basic rules associated with **valence shell electron pair repulsion theory** known by the abbreviation **VSEPR** theory
- **VSEPR** theory consists of three basic rules:
 - All electron pairs and all lone pairs arrange themselves as far apart in space as possible.
 - Lone pairs repel more strongly than bonding pairs
 - Multiple bonds behave like single bonds
- For more information about valence shell electron pair repulsion theory, see our revision note on [Shapes of Molecules](#)

Molecular geometry versus electron domain geometry

- It is important to distinguish between molecular geometry and electron domain geometry in exam questions
 - Molecular geometry refers to the shape of the molecules based on the relative orientation of the atoms
 - Electron domain geometry refers to the relative orientation of all the bonding and lone pairs of electrons
- The Lewis formula for water enables us to see that there are four electron pairs around the oxygen so the electron domain geometry is tetrahedral
- However, the molecular geometry shows us there are two angled bonds so the shape is bent, angular, bent linear or V-shaped (when viewed upside down)

Lewis formula and molecular shape of water

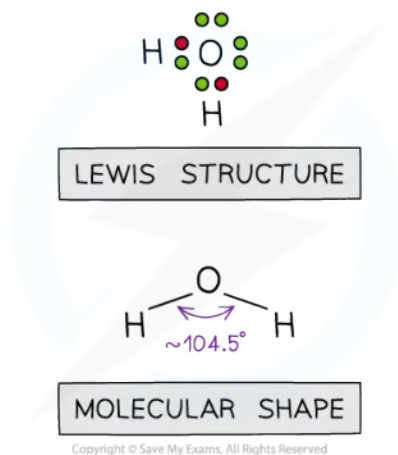

The Lewis formula of water and molecular shape can be used to determine the electron domain and molecular geometries



Your notes

Five electron domains

Table of molecular geometries associated with five electron domains

Electron domain geometry	Bonding pairs	Lone pairs	Molecular geometry	Shape example
trigonal bipyramidal	5	0	trigonal bipyramidal	
trigonal bipyramidal	4	1	seesaw	
trigonal bipyramidal	3	2	T-shape	

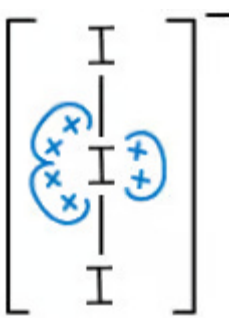

trigonal bipyramidal	2	3	Linear	
----------------------	---	---	--------	------------------------------------------------------------------------------------

- PCl_5 is a symmetrical molecule so the electron cloud charge is evenly spread
 - This means that it will be a non-polar molecule as any dipoles from the P-Cl bonds would be cancelled out
- SF_4 and ClF_3 are asymmetrical molecules having one or two lone pairs on one side of the central axis making the overall molecule polar

Six electron domains

Table of molecular geometries associated with six electron domains

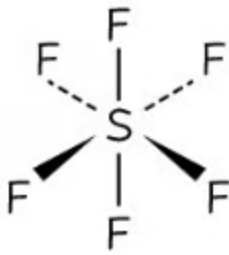
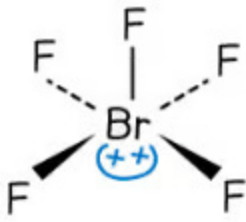
Electron domain geometry	Bonding pairs	Lone pairs	Molecular geometry	Shape example
octahedral	6	0	octahedral	
octahedral	5	1	square based pyramid	

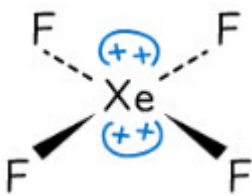
octahedral	4	2	square planar	
------------	---	---	---------------	------------------------------------------------------------------------------------



- SF_6 is a symmetrical molecule so the electron cloud charge is evenly spread with 90° between the bonds
 - This means that it will be a non-polar molecule as any dipoles from the S-F bonds would be cancelled out
- XeF_4 is also non-polar despite having two lone pairs
 - The bonding pairs are at 90° to the plane and the lone pairs are at 180°
 - The lone pairs are arranged above and below the square plane resulting in an even distribution of electron cloud charge
- BrF_5 is asymmetrical having a lone pair at the base of the pyramid making the overall molecule polar

Worked example

What is the electron domain geometry, molecular geometry and F-Xe-F bond angle of xenon difluoride, XeF_2 ?

Answer

- Count the valence electrons = $\text{Xe} + 2\text{F} = 8 + (2 \times 7) = 22$
- There are two bonding pairs, accounting for 4 electrons, so 18 electrons remain
- Each fluorine should have 3 lone pairs, accounting for 6 pairs or 12 electrons, which leaves 3 lone pairs on the xenon
- Xenon, therefore, has 2 bonding pairs and 3 lone pairs meaning it has:
 - Electron domain geometry = **trigonal bipyramid**
 - Molecular geometry = **linear**
- The bond angle will be **180°** (having the same structure as the triiodide ion)

Examiner Tip

Lewis structure and Lewis formula may be used interchangeably, but Lewis formula is the preferred term in the specification.



Your notes

Formal Charge (HL)

Formal Charge

- A limitation of the model of covalent bonding is that when drawing Lewis formulas for molecules, it is sometimes possible to come up with more than one structure while still obeying the **octet rule**
- This leads to the problem of deciding which structure is appropriate and is consistent with other information such as spectroscopic data on bond lengths and electron density
- One approach to determining which is the preferred structure is to determine the **formal charge (FC)** of all the atoms present in the molecule
- It is a kind of electronic book keeping involving the bonding, non-bonding and valence electrons
- Formal charge is described as the charge assigned to an atom in a molecule, assuming that all the electrons in the bonds are shared equally between atoms, regardless of differences in **electronegativity**
- The formula for calculating FC is

$$\text{FC} = (\text{number of valence electrons}) - \frac{1}{2}(\text{number of bonding electrons}) - (\text{number of non-bonding electrons})$$

or

$$\text{FC} = \text{V} - \frac{1}{2}\text{B} - \text{N}$$

- The Lewis formula which is preferred is the one which:
 - the **difference** in FC of the atoms is **closest to zero**
 - has negative charges located on the most electronegative atoms
- The process of drawing a Lewis formula has been covered previously, but here is a reminder of how to draw the Lewis formula of tetrachloromethane, CCl_4 .

Diagram to show the Lewis formula of carbon tetrachloride



1 TOTAL NUMBER OF VALENCE ELECTRONS = C + 4Cl = 4 + (4 × 7) = 32

2 DRAW THE SKELETAL POSITIONS

3 ADD THE BONDING PAIRS

ADD 24 LONE PAIR ELECTRONS

4 COMPLETED LEWIS STRUCTURE

$\begin{array}{c} \text{Cl} \\ \text{Cl} \text{ C } \text{Cl} \\ \text{Cl} \\ \text{Cl} \\ \text{Cl} : \text{C} : \text{Cl} \\ \text{Cl} \end{array}$

4 BONDING PAIRS MEANS 32 - 8 = 24 ELECTRONS LEFT

$\begin{array}{c} : \ddot{\text{Cl}} : \\ : \ddot{\text{Cl}} : \text{C} : \ddot{\text{Cl}} : \\ : \ddot{\text{Cl}} : \end{array}$

LONE PAIRS

Copyright © Save My Exams. All Rights Reserved

Steps in drawing the Lewis formula for CCl_4

- To work out the formal charge of the C and Cl atoms in the structure simply apply the FC formula:

$$\text{FC for carbon} = (4) - \frac{1}{2}(8) - 0 = 0$$

$$\text{FC for chlorine} = (7) - \frac{1}{2}(2) - 6 = 0$$

- Notice that formal charge is calculated for one of each type of atom and does not count the total number of atoms in the molecule



Your notes

Worked example

What is the formal charge on boron in the BH_4^- ion?

Answer

- Boron is a group 13 element, so has 3 valence electrons. Hydrogen has one valence electron and the charge on the ion is -1 , so there are 8 electrons in the diagram. The Lewis formula is therefore:

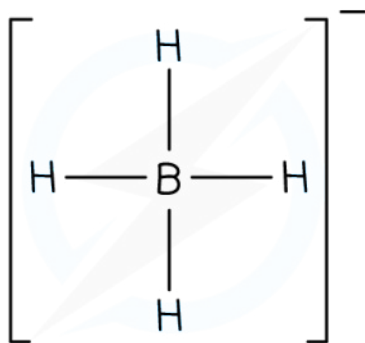

Copyright © Save My Exams. All Rights Reserved

Lewis formula of BH_4^-

- The number of bonded electrons is 8 and the number of non-bonded electrons is zero. So the formal charge on B is:
- $\text{FC}(\text{B}) = (3) - \frac{1}{2}(8) - 0 = -1$

- It is possible to draw three resonance structures for sulfur dioxide, SO_2 :

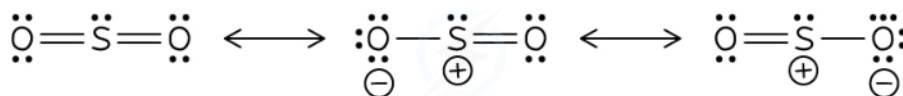

Copyright © Save My Exams. All Rights Reserved

The three resonance structures of sulfur dioxide

- The first structure is an illustration of the expansion of the octet as the sulfur has 10 electrons around it
- Formal charge can be used to decide which of the Lewis formulas is preferred
- The FC on the first structure is as follows:

$$\text{FC on sulfur} = (6) - \frac{1}{2}(8) - (2) = 0$$

$$\text{FC on oxygen} = (6) - \frac{1}{2}(4) - (4) = 0$$

$$\text{Difference in FC} = \Delta\text{FC} = \text{FC}_{\text{max}} - \text{FC}_{\text{min}} = 0$$

- The FC on the second (and third) structures is as follows:



$$\text{FC on sulfur} = (6) - \frac{1}{2}(6) - (2) = +1$$

$$\text{FC on left side oxygen} = (6) - \frac{1}{2}(2) - (6) = -1$$

$$\text{FC on right side oxygen} = (6) - \frac{1}{2}(4) - (4) = 0$$

$$\text{Difference in FC} = \Delta\text{FC} = \text{FC}_{\text{max}} - \text{FC}_{\text{min}} = 2$$

Worked example

What is the formal charge on the two resonance structures shown?



Resonance structures of carbon dioxide

Deduce which is the preferred structure.

Answer

Structure I

- FC on carbon = $(4) - \frac{1}{2}(8) - (0) = 0$
- FC on oxygen = $(6) - \frac{1}{2}(4) - (4) = 0$
- Difference in FC = $\Delta\text{FC} = \text{FC}_{\text{max}} - \text{FC}_{\text{min}} = 0$

Structure II

- FC on carbon = $(4) - \frac{1}{2}(8) - (0) = 0$
- FC on left oxygen = $(6) - \frac{1}{2}(6) - (2) = +1$
- FC on right oxygen = $(6) - \frac{1}{2}(2) - (6) = -1$
- Difference in FC = $\Delta\text{FC} = \text{FC}_{\text{max}} - \text{FC}_{\text{min}} = 2$

Structure I is the preferred structure as the difference is zero

Examiner Tip

The term Lewis structure and Lewis formula mean the same thing.



Your notes

Sigma & Pi Bonds (HL)

Sigma & Pi Bonds

Bond overlap in covalent bonds

- A single **covalent bond** is formed when two non-metals combine
- Each atom that combines has an **atomic orbital** containing a single unpaired electron
- When a covalent bond is formed, the **atomic orbitals** overlap to form a **combined orbital** containing two electrons
 - This new orbital is called the **molecular orbital**
 - The shape of the molecular orbital is dependent on the shape of the atomic orbitals that combined
- The **greater** the atomic orbital overlap, the **stronger** the bond
- There are two main types of molecular orbital: a **sigma (σ) bond** and a **pi (π) bond**

What is a sigma bond?

- **Sigma (σ) bonds** are formed from the head-on / end-to-end **combination** or **overlap** of atomic orbitals
- The electron density is concentrated along the bond axis (an imaginary line between the two nuclei)
- s orbitals overlap this way as well as p to p, and s with p orbitals

The formation of sigma bonds from s orbitals

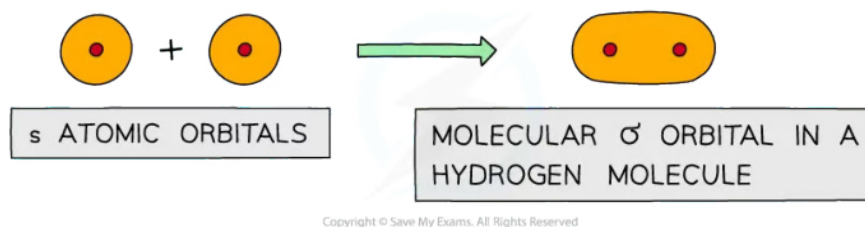

Sigma orbitals can be formed from the head-on combination of s orbitals

The formation of sigma bonds from an s and a p orbital



Hydrogen fluoride has sigma bonds between s and p orbitals

The formation of sigma bonds from p orbitals

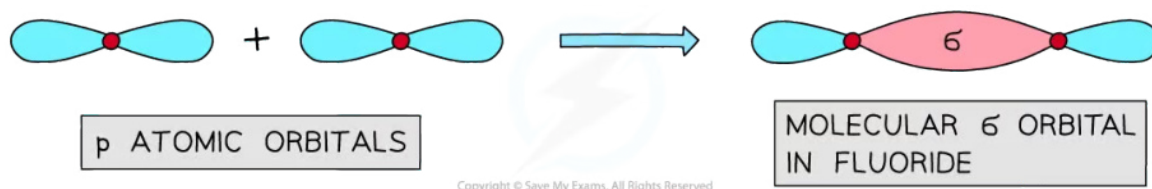

Fluorine has sigma bonds between p orbitals

- The electron density in a σ bond is symmetrical about a line joining the nuclei of the atoms forming the bond
- The electrostatic attraction between the electrons and nuclei bonds the atoms to each other
- A **single** covalent bond is always a **sigma** bond

What is a pi bond?

- Pi (π) bonds are formed from the **lateral** (sideways) **combination** or **overlap** of **adjacent** p orbitals
- The two lobes that make up the π bond lie **above and below the plane** of the σ bond
- This maximises the overlap of the p orbitals
- A single π bond is drawn as **two electron clouds** one arising from each lobe of the p orbitals
- The two clouds of electrons in a π bond represent **one** bond containing **two electrons**
- The electron density is concentrated on **opposite** sides of the bond axis
- **π bonds** are only found within **double** and **triple** bonds

The formation of a pi bond from p orbitals

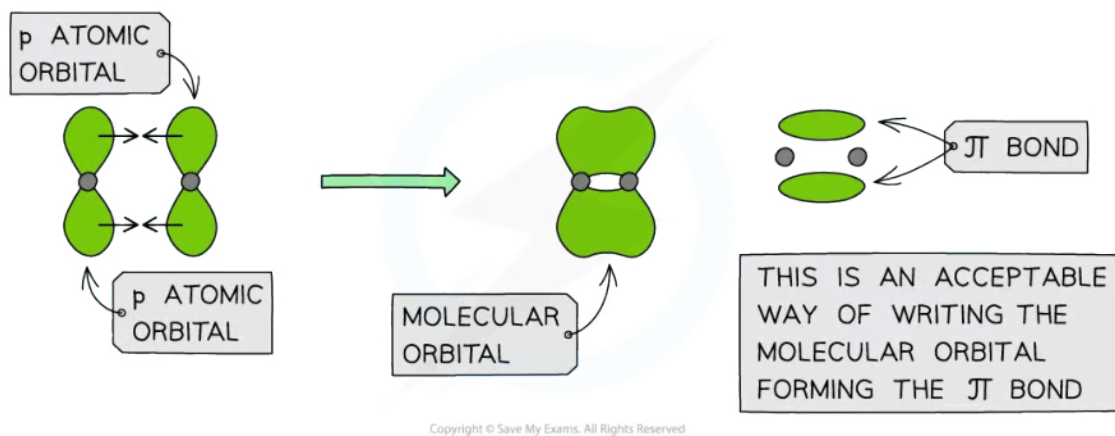

π orbitals are formed by the lateral combination of p orbitals



Your notes

Examples of sigma & pi bonds

Hydrogen

- The hydrogen atom has only one s orbital
- The s orbitals of the two hydrogen atoms will overlap to form a σ bond

The formation of a sigma bond in hydrogen

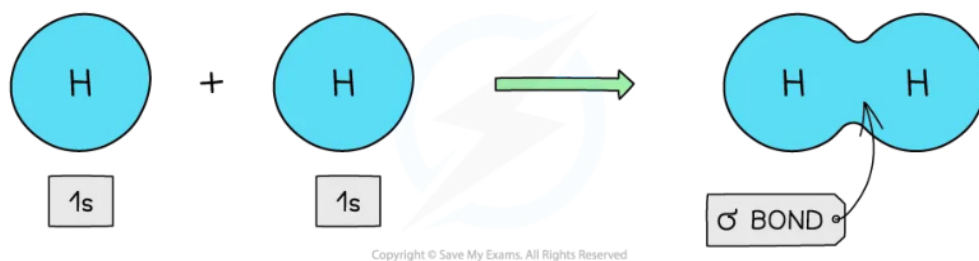

Direct overlap of the 1s orbitals of the hydrogen atoms results in the formation of a σ bond

Ethene

- Each carbon atom uses **three** of its **four** electrons to form σ bonds
- Two σ bonds are formed with the hydrogen atoms
- One σ bond is formed with the other carbon atom
- The fourth electron from each carbon atom occupies a p orbital which overlaps **sideways** with another p orbital on the other carbon atom to form a π bond
- This means that the C-C is a **double bond**: one σ and one π bond

The formation of a pi bond in ethene

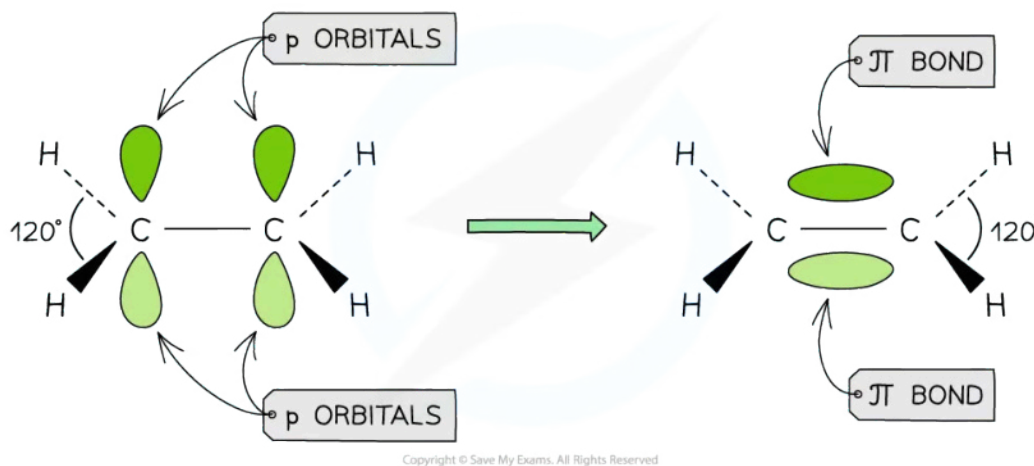

Overlap of the p orbitals results in the forming of a π bond in ethene



The formation of sigma bonds and a pi bond in ethene

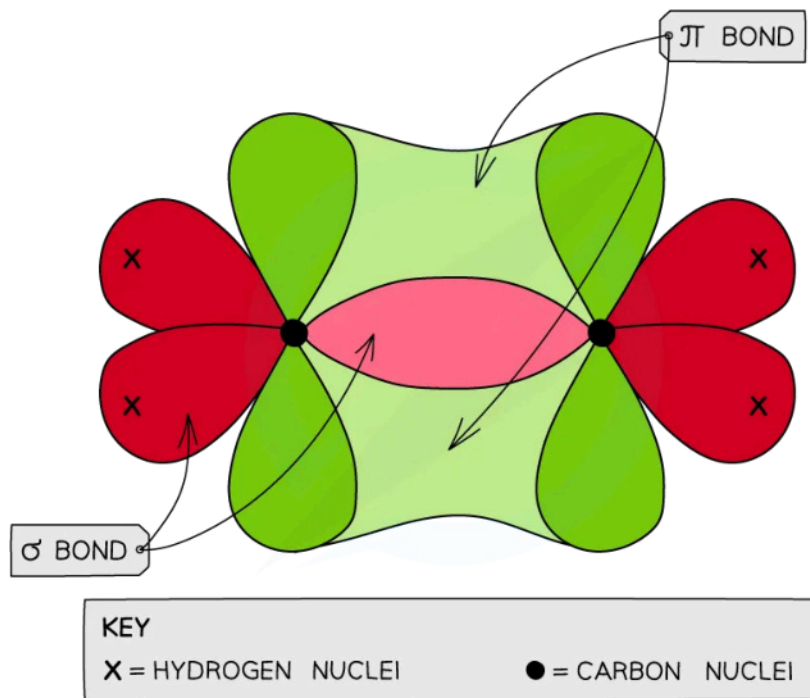

Each carbon atom in ethene forms two sigma (σ) bonds with hydrogen atoms and one sigma (σ) bond with another carbon atom. The fourth electron is used to form a pi (π) bond between the two carbon atoms

Ethyne

- This molecule contains a **triple bond** formed from **two π bonds** (at right angles to each other) and **one σ bond**
- Each carbon atom uses **two** of its **four** electrons to form σ bonds
- One σ bond is formed with the hydrogen atom
- One σ bond is formed with the other carbon atom
- Two electrons are used to form two π bonds with the other carbon atom

The formation of sigma bonds and pi bonds in ethyne

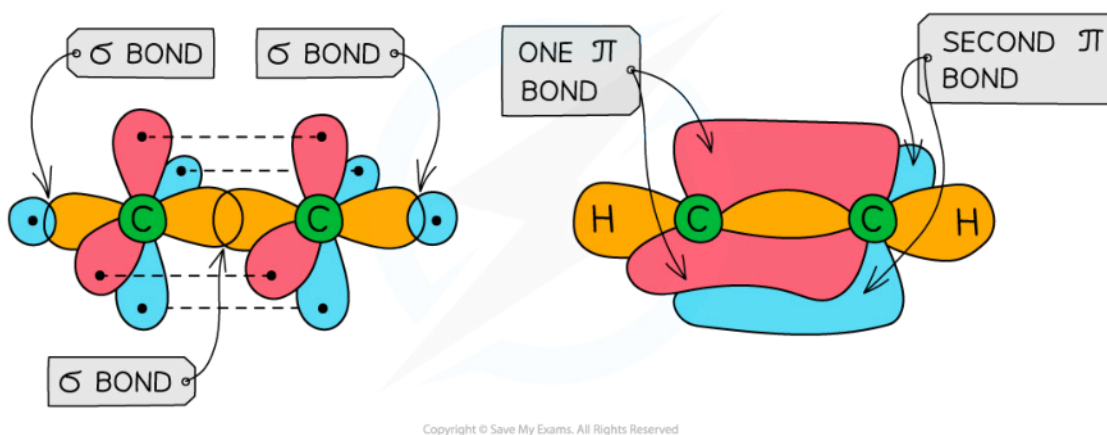

Ethyne has a triple bond formed from two π bonds and one σ bond between the two carbon atoms

Predicting the Type of Bonds

- Whether sigma (σ) or pi (π) bonds are formed can be predicted by consideration of the combination of atomic orbitals

Worked example

What type of molecular orbitals are found in the following chemicals?

1. Nitrogen, N_2
2. Hydrogen cyanide, HCN

Answer 1:

- Nitrogen contains a **triple bond** and a **lone pair** on each nitrogen atom
- Nitrogen atoms have the electronic configuration $1s^2 2s^2 2p^3$
- The triple bond is formed from one σ bond between the two nitrogen atoms and the lateral overlap of **two sets** of p orbitals on the nitrogen atoms to form **two π bonds**
- **NOTE:** The σ bond between the two nitrogen atoms is formed from the head-on overlap of two sp hybrid orbitals
 - For more information, see our revision notes on [Hybridisation](#)
- The two π bonds are at **right angles to each other**

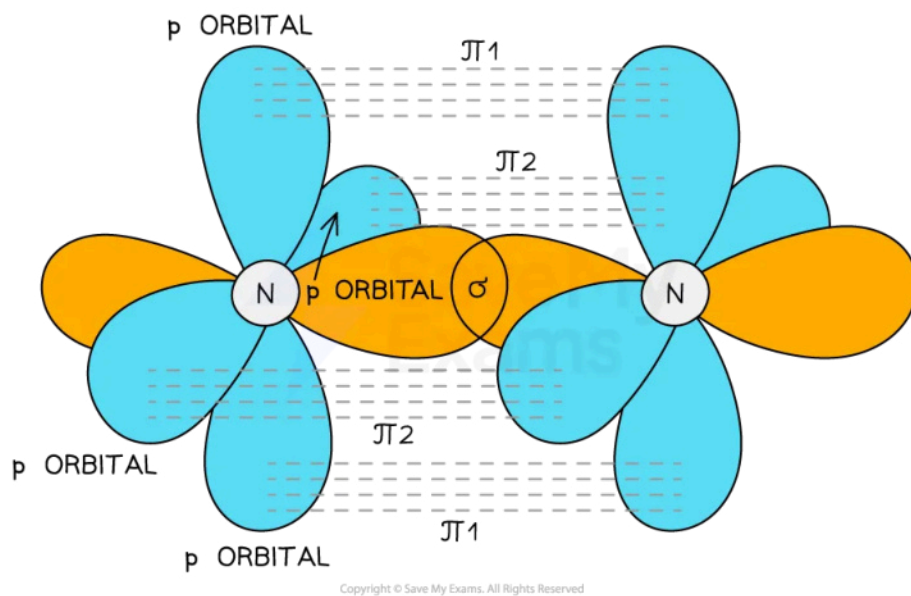

The triple bond is formed from two π bonds and one σ bond

Answer 2:

- Hydrogen cyanide contains a **triple bond**
- One σ bond is formed between the H and C atom
- A second σ bond is formed between the C and N atom

- The remaining **two sets** of p orbitals of **nitrogen and carbon** will overlap to form **two π bonds** at right angles to each other

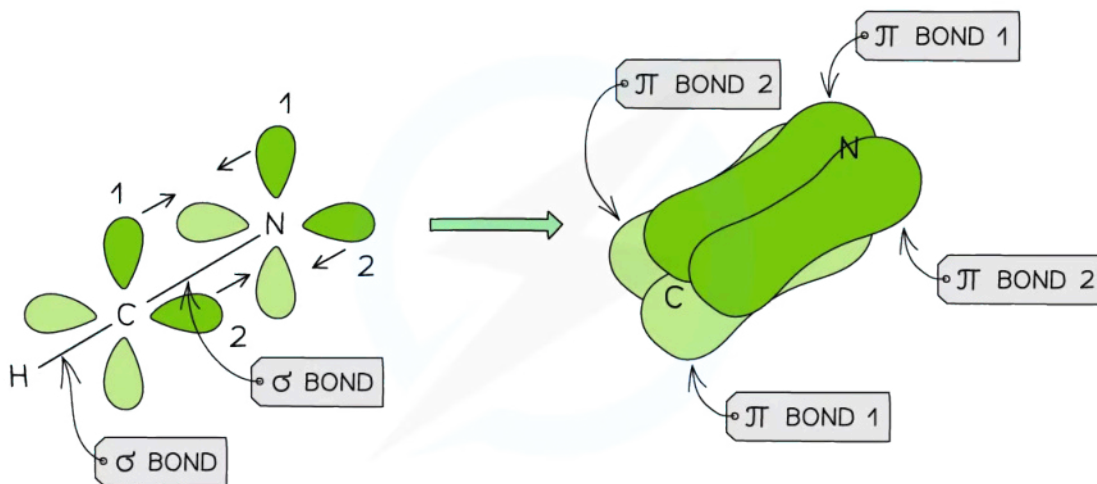

Copyright © Save My Exams. All Rights Reserved

Hydrogen cyanide has a triple bond formed from a σ bond and the overlap of two sets of p orbitals of nitrogen



Your notes



Your notes

Hybridisation (HL)

Hybridisation

What is hybridisation?

- The ground state of the electrons in a carbon atom is $1s^2 2s^2 2p^2$
- This can be represented using a spin diagram as shown:

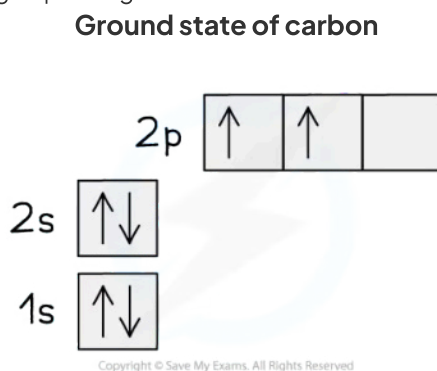

Orbital spin diagram for carbon in the ground state

- This electronic structure would imply that carbon forms two covalent bonds using the unpaired 2p electrons
- Since the 2s electrons are paired there would be no reason for them to be involved in bonding
- However studies of carbon compounds show that carbon typically forms four covalent bonds that are all equal in energy
- This puzzle has been explained using the theory of **bond hybridisation**
- A half full p-subshell has a slightly lower energy than a partially filled one. The difference in energy between the 2s and 2p subshells is small, so an electron can fairly easily be promoted from the 2s to the 2p giving the new arrangement:

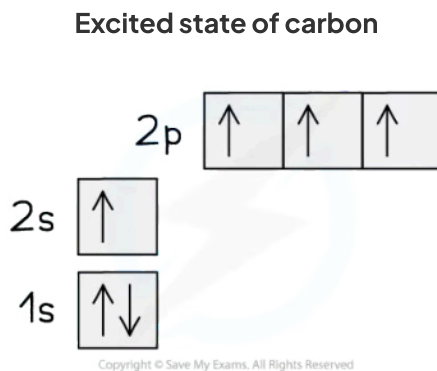

Orbital spin diagram for carbon in the excited state



Your notes

- The 2s and 2p subshells blend together and form four new hybrid orbitals (called sp^3 orbitals, after the merger of an s and 3 p orbitals)
- This would give four unpaired electrons of equal energy, capable of forming four covalent bonds.

sp^3 hybrid orbitals

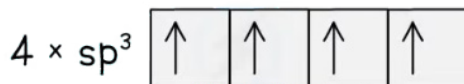

Copyright © Save My Exams. All Rights Reserved

Orbital spin diagram for carbon showing sp^3 hybrid orbitals

- The theory of Quantum mechanics shows that the shape of a 1s orbital is spherical and a p orbital is dumbbell or figure-of-eight shaped
- There are three p orbitals all at right angles to each other, known as p_x , p_y and p_z

The shape of s and p orbitals

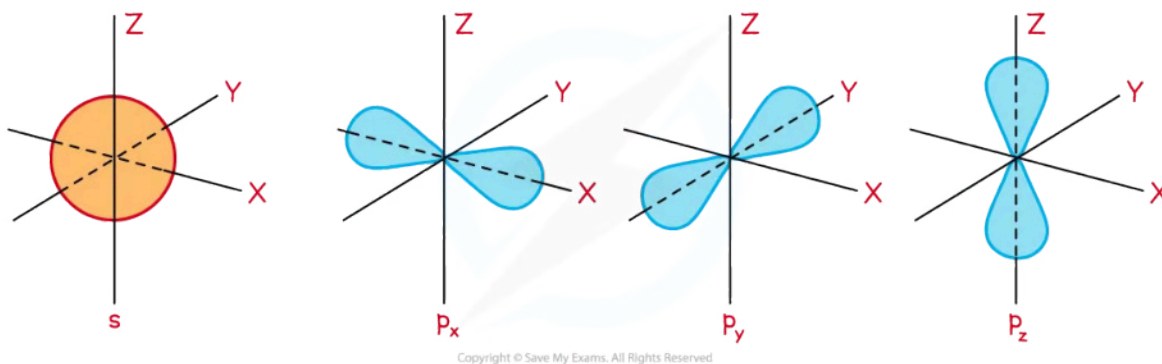

Copyright © Save My Exams. All Rights Reserved

The s orbital is spherical and the three dumbbell-shaped p orbitals lie at right angles to each other

What is sp^3 hybridisation?

- Four hybrid orbitals are produced when the 2s and three 2p orbitals blend together
- These hybrids have $\frac{1}{4}$ s character and $\frac{3}{4}$ p character so they have a club shape reminiscent of an enlarged p orbital
- The four sp^3 hybrid orbitals space themselves out at 109.5° forming a tetrahedron
- This is the resolution of the structure seen when carbon forms single bonds, such as would be found in methane

sp^3 hybridised orbitals

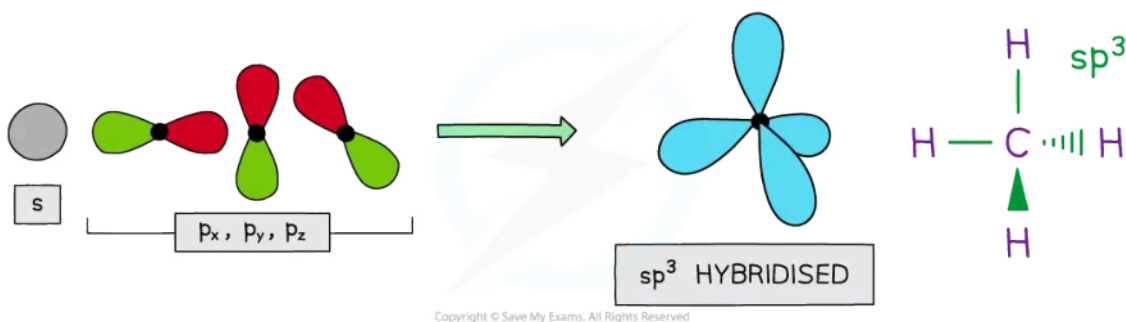

4 x sp^3 hybrid orbitals are formed from one s orbital and three p orbitals

- The sp^3 orbitals merge with the s orbitals in hydrogen forming four equal sigma bonds
- It is not just bonding pairs of electrons that are accommodated in hybrid orbitals - lone pairs can also be present
- The domain geometry of ammonia is tetrahedral due to sp^3 hybrid orbitals where three bonding pairs and one lone pair are found

What is sp^2 hybridisation?

- Three hybrid orbitals are produced when the $2s$ and two $2p$ orbitals blend together
- These hybrids have $\frac{1}{3}$ s character and $\frac{2}{3}$ p character
- The three sp^2 hybrid orbitals space themselves out at 120° forming a trigonal planar geometry
- This is the resolution of the structure seen when carbon forms two single bonds and a double bond with another carbon in alkenes

sp^2 hybridised orbitals

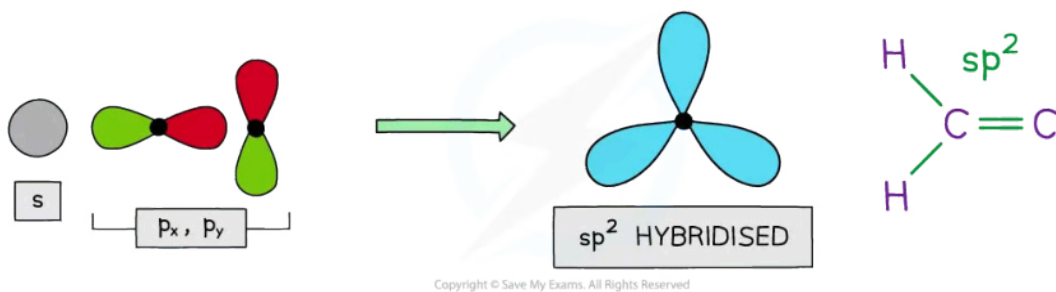

3 x sp^2 hybrid orbitals are formed from one s orbital and three p orbitals

- In the case of carbon, the sp^2 orbitals merge with the s orbitals in hydrogen and the sp^2 of an adjacent carbon, forming three equal sigma bonds
- The double bond is created by the sideways (lateral) overlap of the unhybridised p -orbitals
- This bonding arrangement can also occur between a double bonded carbon and oxygen so is typically seen in the carbonyl group

What is sp hybridisation?

- Two hybrid orbitals are produced when the 2s and one 2p orbital blend together
- These hybrids have $\frac{1}{2}$ s character and $\frac{1}{2}$ p character
- The two sp hybrid orbitals space themselves out at 180° forming linear geometry
- This is the resolution of the structure seen when carbon forms one single bonds and a triple bond with itself in alkynes

sp hybridised orbitals

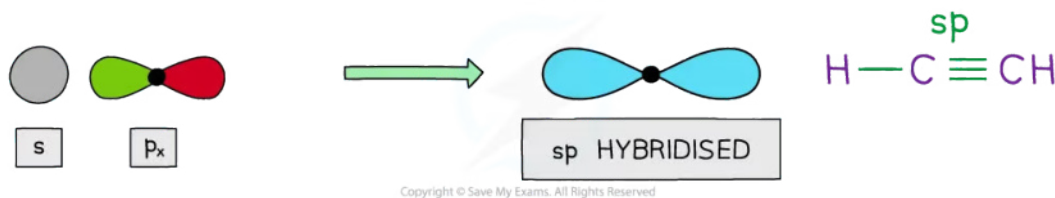

2 x sp hybrid orbitals are formed from one s orbital and two p orbitals

- In the case of carbon, the sp orbital merges with the s orbital in hydrogen and the sp of an adjacent carbon, forming two equal sigma bonds
- The triple bond is created by the sideways overlap of two pairs of the unhybridised p-orbitals, set at right angles to each other

Examiner Tip

Carbon can form 4 bonds. To help remember how the type of bonding relates to the hybridisation of the carbon atomic orbitals:

- For **sp³**: $4 - 3 = 1$ so the carbon atom forms **single** bonds
- For **sp²**: $4 - 2 = 2$ so the carbon atom forms a **double** bond
- For **sp**: $4 - 1 = 3$ so the carbon atom forms a **triple** bond