

DP IB Environmental Systems & Societies (ESS): HL



Your notes

2.1 Individuals, Populations, Communities & Ecosystems

Contents

- * Introduction to Ecological Systems
- * Classification & Taxonomic Tools
- * Human Populations
- * Factors Affecting Populations
- * Population Growth
- * Studying Populations
- * Ecosystem Functioning & Sustainability
- * Classification (HL)
- * Fundamental & Realised Niches (HL)
- * Life Cycles (HL)

Introduction to Ecological Systems



Your notes

Introduction to Ecological Systems

The biosphere

- The **biosphere** refers to the **narrow, life-supporting zone** around the Earth
 - It is where the air (**atmosphere**), water (**hydrosphere**) and land (**lithosphere**) meet
- The biosphere contains all living organisms, including:
 - Plants (flora)
 - Animals (fauna)
 - Fungi and microorganisms
- It can be thought as **one large, complex system** of living communities, as well as their interactions with each other and with the non-living components of the Earth's systems, all interacting as a **single unit**



Your notes

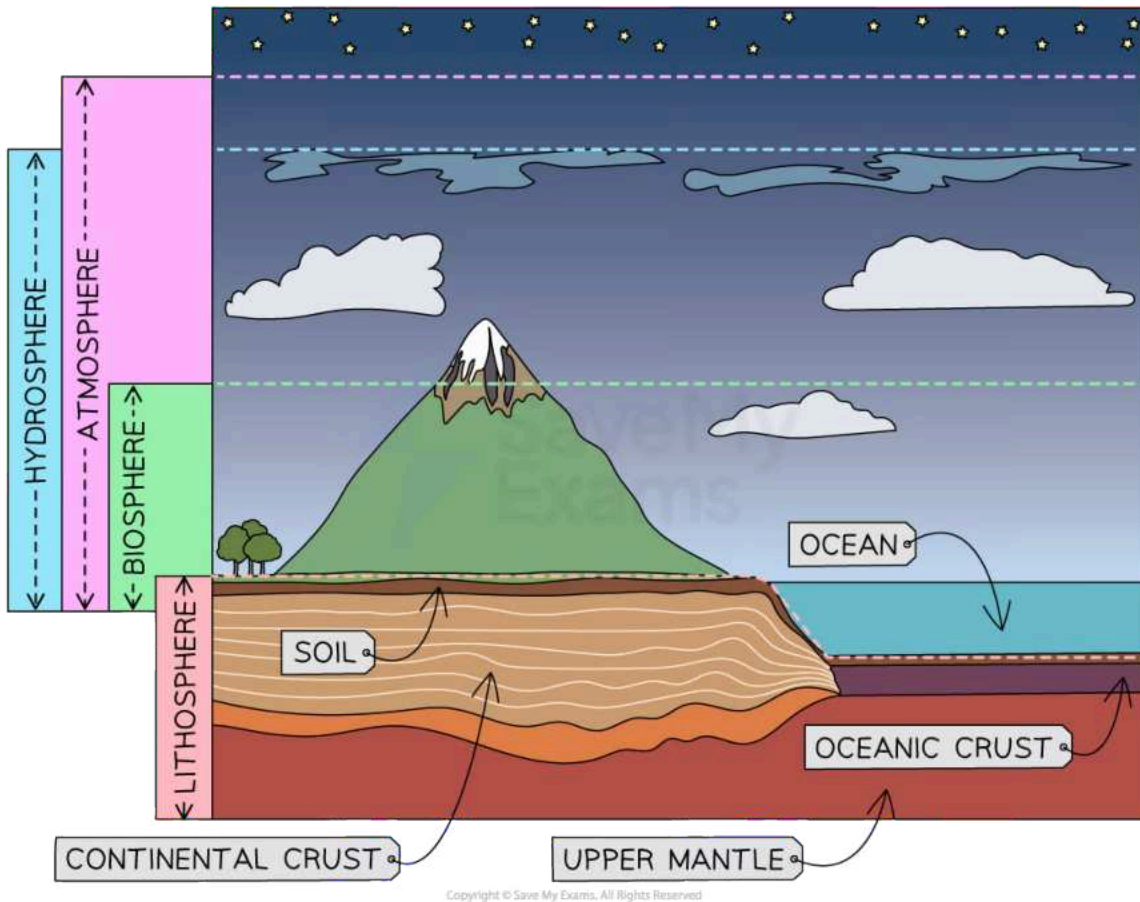

Biosphere

The biosphere measures approximately 20 km from top to bottom—however, most life exists in a narrow range of 6.5 km (500 m below sea level and 6 km above sea level)

Species

- A species is a group of organisms sharing common characteristics that **interbreed** to produce **fertile offspring**
 - This is known as the **biological species concept**
 - Members of the same species share a gene pool, meaning that they can breed and produce offspring with similar traits

Populations

- A population is a group of organisms of the **same species** living in the **same area** at the **same time** which interbreed



Your notes

- A population can be seen as an **interbreeding unit** of a species
- One species may consist of any number of populations, from one to many—for example:
 - The Eastern Grey Kangaroo is a species of marsupial native to Australia
 - This species consists of multiple populations across various regions of Australia
 - There are populations of Eastern Grey Kangaroos in Queensland, New South Wales, Victoria and other parts of the country
 - Although individuals from these different populations are capable of interbreeding, in reality they very rarely do due to the fact that they are **geographically isolated** (separated) from each other
 - Each population may have its own unique characteristics and adaptations based on local factors such as habitat, climate and food availability
 - Despite being part of the same species, these populations may exhibit some small genetic and behavioural differences due to their isolation and local environmental conditions

Community

- A community includes all of the different **populations** (of different species) living in the **same area** at the **same time**
 - A community is a collection of **interacting** populations within an ecosystem
 - For example, each species within a community depends on other species for food, shelter, pollination, seed dispersal, etc.

Habitat

- A habitat is the **local environment** in which an organism, species, population or community normally lives
 - E.g. badgers, deer, oak trees and ants are all species that would live in a **woodland habitat**
 - A description of the habitat of a species can include both **geographical** and **physical** locations, as well as the type of ecosystem required to meet all environmental conditions needed for the survival of the organism, species, population or community

Ecosystems

- An ecosystem refers to a community of living organisms, along with their physical environment, interacting as a system within a specific area
 - This includes the living, **biotic** components (such as plants, animals, fungi and microorganisms) interacting with the non-living, **abiotic** components (such as soil, water, air, sunlight, temperature, humidity and minerals)

- These abiotic components provide the essential resources and conditions necessary for the survival and functioning of the biotic community
- Together, the interactions between biotic and abiotic components shape the structure and dynamics of the ecosystem, influencing factors such as biodiversity, nutrient cycling and ecosystem services
- Ecosystems **vary in size**, from small ponds to vast forests
- Each ecosystem has its own **unique characteristics**, shaped by factors like geography, climate and the species present within it
- Ecosystems are **open systems** in which both **energy** and **matter** can enter and exit. For example:
 - **Photosynthetic** organisms such as plants and algae capture sunlight, which is the primary source of energy for ecosystems
 - **Energy exits** ecosystems primarily through **heat** released during cellular respiration, lost during trophic transfers (e.g. from herbivores to carnivores) and **radiated** from the Earth's surface into space
 - **Matter** can **enter or exit ecosystems** in the form of **water, nutrients, gases** or **waste** products produced by animals



Your notes



Your notes

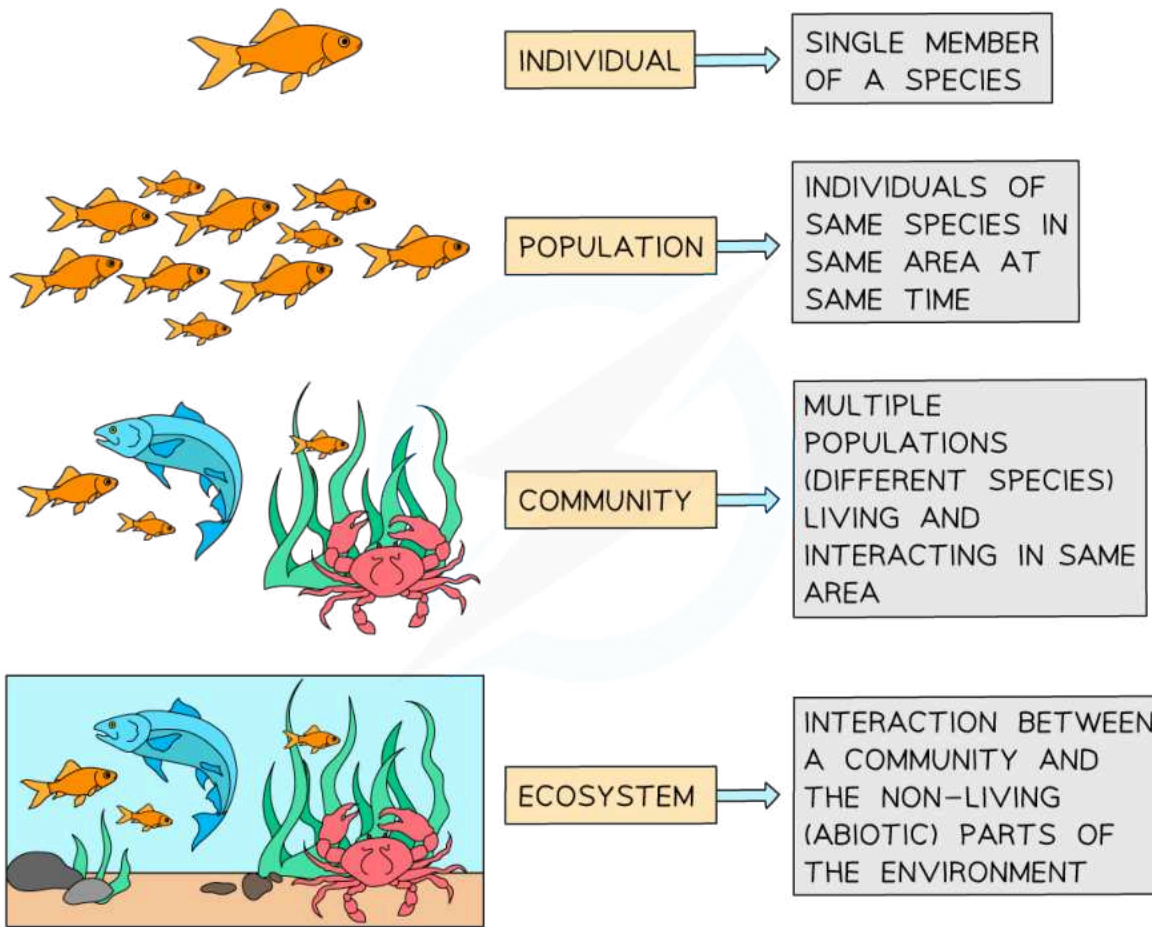

Copyright © Save My Exams. All Rights Reserved

Levels of organisation in an ecosystem



Your notes

Classification & Taxonomic Tools

Classification

- There are millions of different **species** that currently exist on Earth
 - Biologists and ecologists can manage and organise this enormous diversity of species by putting **similar** species together into **groups**
- This process is known as **classification**
 - It involved organising and categorising species based on their similarities and differences
 - Species are grouped into a hierarchy of different categories according to the **biological characteristics** that they **share**
 - Classifying species in this way allows us to quickly identify them and predict their characteristics

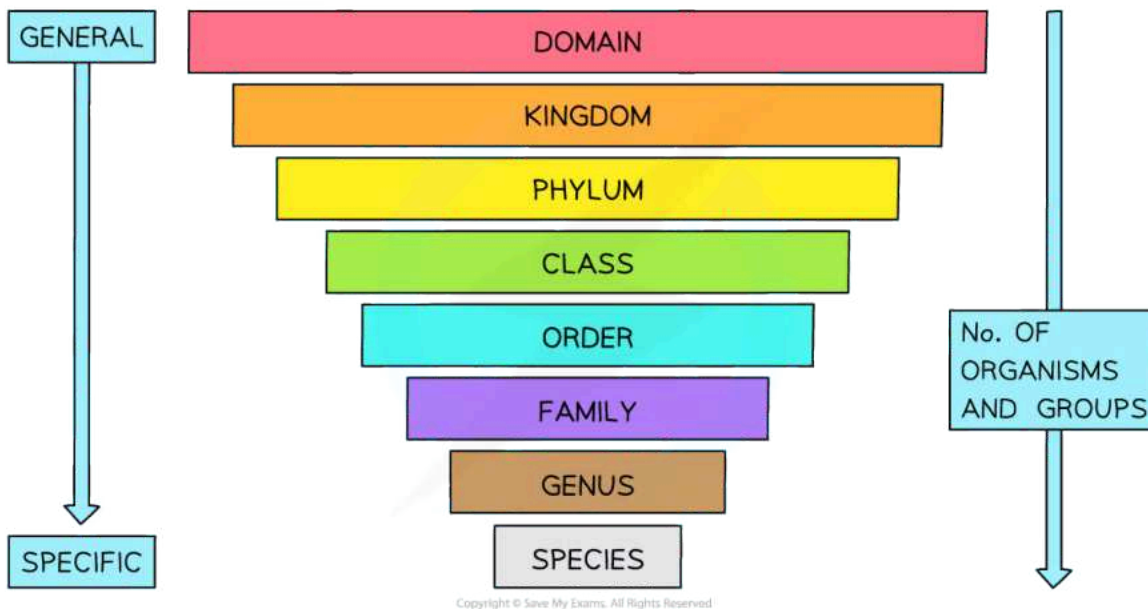

The hierarchical classification system—the higher ranks contain more organisms with less similarity between them and the lower ranks contain fewer organisms with more similarity between them

- The first step to classifying a species is to put it into a group known as a **genus**
 - A genus is a category in the classification hierarchy that includes **one or more species** that are closely related and share common characteristics



Your notes

- Every species gets a **two-part name** in the following format: the name of the genus, then the name of the species
 - The genus name is always written first and with a capital letter
 - The species name does not have a capital letter
 - Both genus and species should be either italicised or underlined.
- For example, humans are called *Homo sapiens*, where **Homo** is the **genus** and **sapiens** is the **species**
 - This could also be written as Homo sapiens
 - Although a genus usually contains more than one species, we are the only species in our genus that exists today
 - However, in the past, there were other species within the *Homo* genus, such as *Homo neanderthalensis* (Neanderthals) and *Homo erectus*, among others
- An example of a well-known genus is the genus *Canis*
 - This genus includes several species of canids or members of the **dog family**, including:
 - *Canis lupus* (Grey wolf)
 - *Canis familiaris* (Domestic dog)
 - *Canis latrans* (Coyote)
 - *Canis aureus* (Golden jackal)
 - *Canis simensis* (Ethiopian wolf)
 - *Canis mesomelas* (Black-backed jackal)
 - *Canis anthus* (African golden wolf)
 - *Canis adustus* (Side-striped jackal)
 - *Canis lupaster* (African wolf)
 - These species share common characteristics, such as similar body structures, behaviours and genetic traits
 - While they may have distinct features and habitats, they are all grouped together under the genus *Canis* due to their close evolutionary relationship and shared ancestry

Taxonomic Tools

- Taxonomists use various tools to identify an organism and to help them decide how to classify it
 - Identification in this context means determining which species an individual organism belongs to



Your notes

Comparison of specimens with reference collections

- Taxonomists can compare unknown specimens with well-documented reference collections
 - These reference collections contain a large number of similar organisms that have already been **identified** and **classified**
 - This method involves **physically comparing** the specimen to known samples
 - It relies on the taxonomist's expertise and the quality of the reference collection
 - For example, a botanist could identify an unknown plant specimen by visually comparing it with a large collection of known plant species at a botanical garden
 - Today there are apps that identify unknown species by comparing a photo to thousands of photos of different species in an online database (a virtual reference collection)

DNA surveys

- DNA surveys involve analysing an organism's DNA to determine its species
 - This method compares the DNA sequence of the specimen with **known sequences** from a very large number of species, stored in very large computer databases
 - It provides **precise** and **reliable** identification, especially for **closely related species**
 - For example, in a wildlife conservation project, researchers could use DNA surveys to distinguish between similar-looking species of butterflies

Dichotomous keys

- Dichotomous keys are tools used to identify organisms based on their **characteristics**
 - The keys consist of a series of paired statements or questions with two possible answers
 - Each pair offers two choices, leading the user to another pair of statements or questions, eventually resulting in the identification of the organism



Your notes

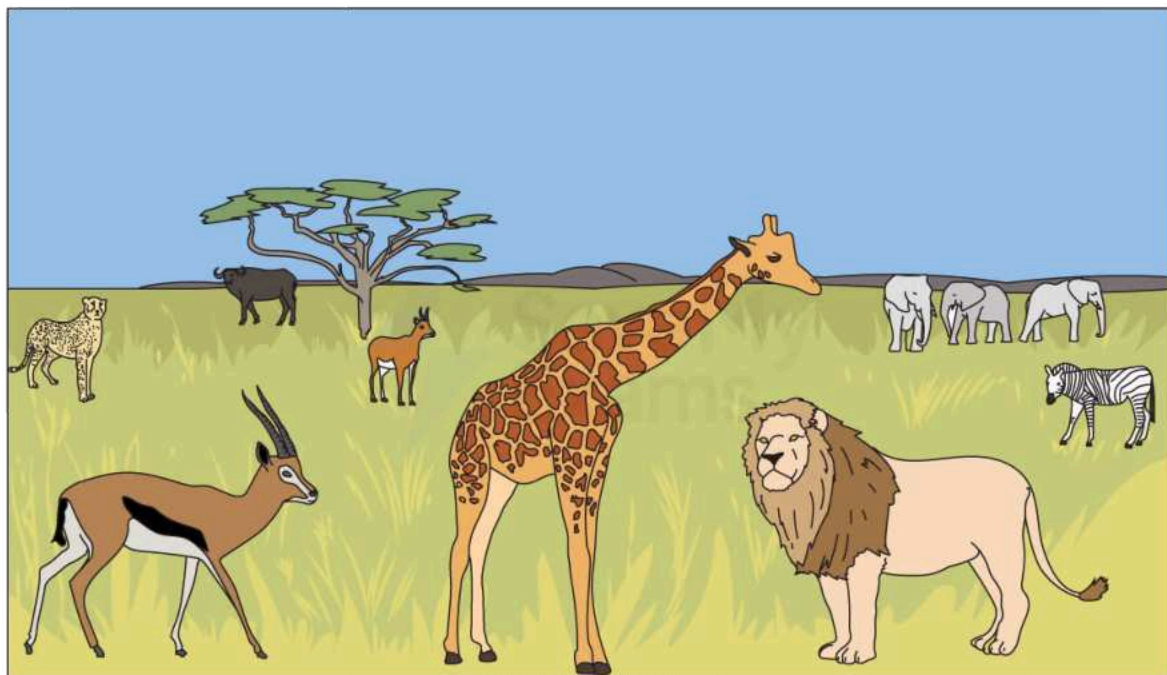

Copyright © Save My Exams. All Rights Reserved

A dichotomous key can be used to identify different species in the Serengeti

- Below is an example of a dichotomous key that can be used to identify eight species in the Serengeti ecosystem:

Serengeti Dichotomous Key

1	a	Animal covered in black and white stripes	Zebra (<i>Equus quagga</i>)
	b	Animal not covered in black and white stripes	go to 2
2	a	Animal is a large cat	go to 3
	b	Animal is not a large cat	go to 4
3	a	Animal covered in spots	Cheetah (<i>Acinonyx jubatus</i>)
	b	Animal not covered in spots	Lion (<i>Panthera leo</i>)
4	a	Animal has horns	go to 5

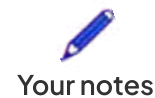

	b	Animal does not have horns	go to 7
5	a	Horns meet in the middle of the head	Cape buffalo (<i>Syncerus caffer</i>)
	b	Horns do not meet in the centre of the head	go to 6
6	a	Horns are long and curved	Grant's gazelle (<i>Nanger granti</i>)
	b	Horns are not long and curved	Oribi (<i>Ourebia ourebi</i>)
7	a	Animal has a long neck	Giraffe (<i>Giraffa camelopardalis</i>)
	b	Animal does not have a long neck	African elephant (<i>Loxodonta africana</i>)

- There are limitations to using a dichotomous identification key:
 - **Limited scope:**
 - Dichotomous keys are typically designed to identify a limited number of species and may not be comprehensive enough to identify all organisms in a given ecosystem
 - **Inaccuracies:**
 - Dichotomous keys are only as accurate as the information provided
 - If the key is not designed properly or lacks important distinguishing characteristics, the identification may be inaccurate
 - **Variability:**
 - Organisms can exhibit variability in their physical characteristics, which can make it difficult to accurately identify them using a dichotomous key
 - **Time-consuming:**
 - Using a dichotomous key can be a time-consuming process, especially for beginners who are not familiar with the organisms in question
 - **Expertise required:**
 - Dichotomous keys require a certain level of expertise and familiarity with the organisms in question
 - Beginners may find it difficult to use the key without assistance from an expert

- **Limited to physical characteristics:**

- Dichotomous keys are limited to the physical characteristics of organisms and may not take into account other important factors, such as behaviour or habitat, which can be important in identifying certain species



Examiner Tips and Tricks

You should try to practice using dichotomous keys with different examples to familiarise yourself with the process, as it can be a little confusing at first, especially when trying to identify closely related species.



Your notes



Your notes

Human Populations

Human Population Growth

Limiting factors on human population growth

- Human societies are increasingly able to **overcome** the limiting factors that once slowed down the growth of human populations
 - As well as allowing human population to dramatically increase in size in over the last few hundred years, this also has many **negative consequences** for the **sustainability of ecosystems**
- The main reasons humans have been able to eliminate these limiting factors include:
 - Elimination of natural predators:**
 - Removal of natural predators like wolves or big cats has led to unchecked growth in certain human populations
 - This has also resulted in imbalances in ecosystems, such as overgrazing by deer populations due to the absence of wolves
 - For example, in Yellowstone National Park, reintroduction of wolves helped control the elk population, which in turn allowed vegetation to regenerate and stabilised the ecosystem
 - Technological advances:**
 - Technological advancements in agriculture and medicine have reduced mortality rates and increased food production
 - This has led to exponential population growth as more people survive and reproduce
 - The Green Revolution in the mid-20th century, with the introduction of high-yield crop varieties and modern agricultural techniques, significantly increased food production globally
 - Degradation of the environment:**
 - Our degradation of the environment has allowed humans to **extract valuable resources** like timber, minerals and fossil fuels
 - Clearing of forests for agriculture and urbanisation provides **more living space** and **land for food production**, increasing human population growth rates
 - Environmental degradation continues to facilitate the extraction of energy sources, such as fossil fuels, which are vital for sustaining growing populations
 - However, these activities also **disrupt ecosystems**, leading to habitat destruction, pollution and resource depletion

- Negative impacts on biodiversity and ecosystem services compromise the sustainability of ecosystems and eventually their ability to support human populations

Assessing carrying capacity for human populations

- Scientists use various methods to estimate the carrying capacity of an environment for a given species
 - These methods include field observations, population surveys, mathematical modelling and data analysis
 - By studying population trends, resource availability and species interactions, researchers can make **informed estimates** of carrying capacity
- However, estimating carrying capacity becomes **challenging** when it comes to **human populations** due to several reasons:

The broad and changing ecological niche of humans

- Populations in ecosystems tend to reach equilibrium when the availability of resources matches the population's needs
- However, humans have a broad and dynamic ecological niche, constantly adapting through technological innovations and changes in consumption patterns

1. Mobility of resources:

- Humans have the ability to move and exploit resources **beyond their immediate habitat**
- This mobility complicates the assessment of carrying capacity, as humans can draw resources from **distant locations**
 - For example, global trade allows societies to access resources like food and materials from around the world, solving the problem of local resource limitations

2. Technological advancements:

- Human societies have the ability to modify their environment and overcome traditional carrying capacity limitations through technology
 - For example, the development of **agriculture** and **irrigation techniques** has allowed humans to increase food production and support larger populations beyond what the natural environment could sustain

3. Cultural and social factors:

- Human population dynamics are influenced by cultural norms, social behaviours and economic factors
 - For example, these can affect **fertility rates** and **migration patterns**, making it difficult to accurately predict or estimate carrying capacity for human populations



Your notes



Your notes

4. Changing lifestyles and consumption patterns:

- Human populations are characterised by varying lifestyles and consumption rates, which can significantly impact resource demands and environmental impacts
 - For example, urbanised societies with high levels of consumption may **strain the carrying capacity** of their surrounding areas due to increased resource demands and waste generation

5. Adaptive capacity:

- More so than any other species, humans have the ability to adapt and innovate in response to changing environmental conditions
- This adaptability can affect carrying capacity by influencing **resource use efficiency** and the development of **technological solutions**

Disputed estimates of carrying capacity

- Urbanisation and industrialisation continually reshape human habitats, making it challenging to estimate carrying capacity
- Estimates are often disputed due to uncertainties in factors like technology, consumption patterns and environmental degradation



Your notes

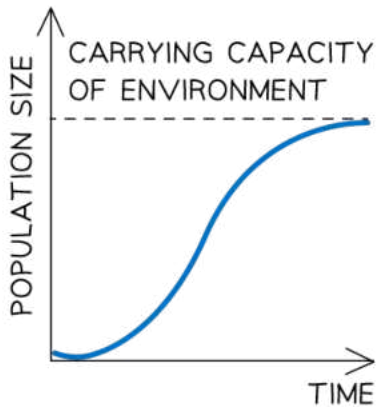

POPULATION GROWS EXPONENTIALLY AS IT CONSUMES RESOURCES UNTIL IT REACHES THE ENVIRONMENT'S CARRYING CAPACITY, WHEREBY IT REMAINS STABLE OR FALLS

IF AT ANY POINT THE CARRYING CAPACITY DECREASES ECONOMIC DEVELOPMENT SLOWS DOWN OR STOPS

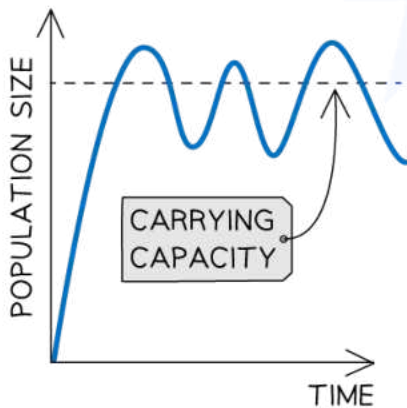

POPULATION GROWS EXPONENTIALLY AND OVERSHOOTS THE LIMIT OF RESOURCES

IT LEADS TO NOT ENOUGH RESOURCES TO GO AROUND SO PEOPLE SUFFER AND DEATH RATES INCREASE. E.g. LACK OF FOOD SUPPLY LEADS TO FAMINE

POPULATION WILL INCREASE AGAIN ONCE IT SINKS BELOW CARRYING CAPACITY AND MORE RESOURCES ARE AVAILIABLE PER PERSON

Copyright © Save My Exams. All Rights Reserved

Two different scenarios showing how human populations may respond to reaching their carrying capacity



Examiner Tips and Tricks

Although our unsustainable extraction of natural resources has allowed many local human populations (as well as the global human population) to overcome various limiting factors and grow exponentially, it is important to note that this environmental degradation, in the long-term, will also negatively impact the ability of ecosystems to support human populations.



Your notes

Factors Affecting Populations

Biotic & Abiotic Factors

- Factors that determine the **distribution** of a **population** can be abiotic or biotic
 - Biotic refers to the **living components** of an ecosystem
 - Abiotic refers to **non-living, physical factors** that may influence organisms

Biotic Factors

- The living, biological factors that influence ecosystems and the communities of organisms within them are termed biotic factors
 - In other words, biotic factors are the **interactions** between the organisms within a population or community
- Biotic factors include:
 - Predation
 - Herbivory
 - Parasitism
 - Mutualism
 - Disease
 - Competition

Examples of Biotic Factors

Biotic Factor	How it Affects Communities	Example
Availability of food	More food means organisms have a higher chance of surviving and reproducing. This means their populations can increase.	Rainforest ecosystems have a rich food supply and this allows many species to live there. Deserts have a poor food supply, which allows fewer species to live there.
New predators	In balanced ecosystems, predators catch enough prey to survive but not so many that they wipe out the prey population. If a new predator is	Red foxes were introduced for recreational hunting in Australia in the 1800s but have since caused the decline of many native species that they feed on, such as small

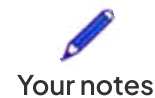

	introduced to the ecosystem, the system may become unbalanced.	mammals and birds. This has also reduced the food supply for native predators.
New pathogens	If a new pathogen enters an ecosystem, the populations living there will have no immunity or resistance to it, and the population may decline or be wiped out.	Avian flu can cause population declines in wild bird species. An outbreak of the H5N1 virus in the bar-headed goose in Qinghai Lake, China, in 2005 caused the deaths of over 6 000 birds in the area, representing a significant proportion of the bar-headed goose population.
Competition	If two species compete for the same resource(s) and one is better adapted to take advantage of these resources, then that species will outcompete the other. This may continue until there are too few members of the less well-adapted species to breed successfully.	North American grey squirrels were introduced to the UK in the 1800s and have since caused a decline in our native red squirrel population. Grey squirrels have outcompeted red squirrels for resources such as food and nest-sites. They also carry a virus (a new pathogen) that red squirrels have no resistance to.



Worked Example

A study recorded the number of red and grey squirrels in a particular woodland habitat for 20 years. Grey squirrels were introduced to the habitat in year 5 of the study. What conclusions can you draw from the graph about the effect of introducing grey squirrels to a habitat that is occupied by red squirrels? Explain why this might have occurred.



Your notes

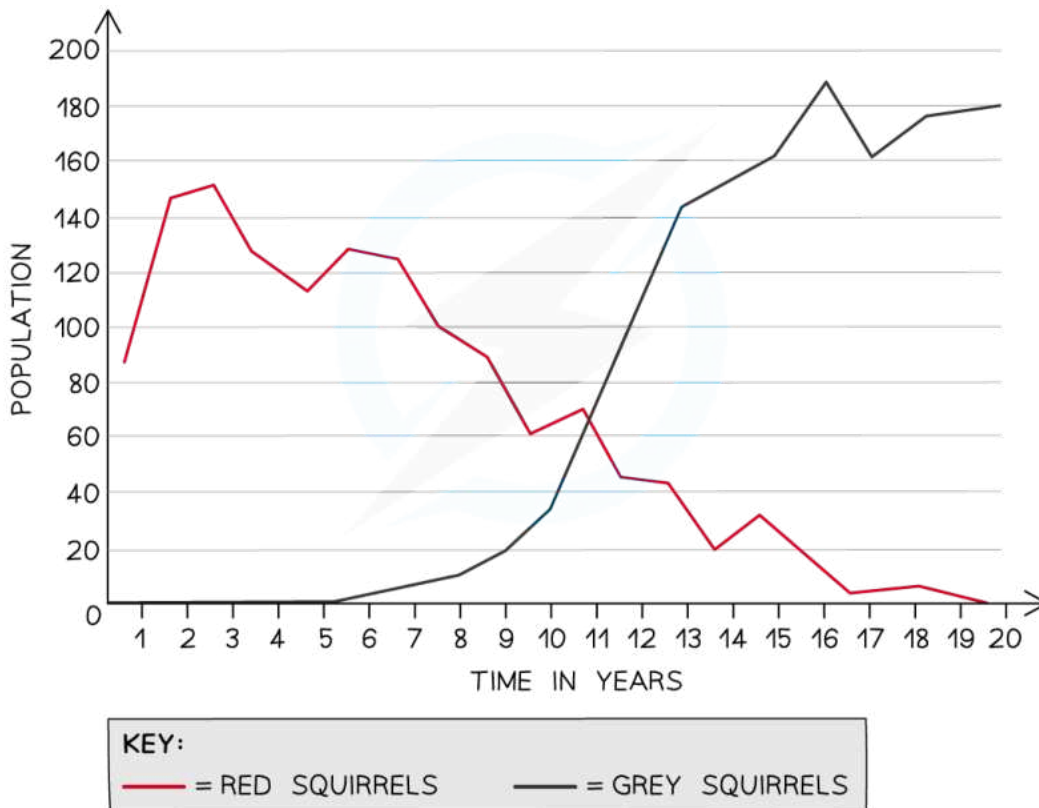

Answer

As the number of grey squirrels increases, the number of red squirrels decreases. This might have occurred because the two squirrel species are competing for one or more of the same resources. Grey squirrels are better adapted to use these resources and have outcompeted the red squirrels until eventually there are too few red squirrels left to breed successfully. At this point, there are no red squirrels left in the habitat; they have become locally extinct.

Abiotic Factors

- The non-living, physical factors that influence ecosystems and the communities of organisms within them are termed abiotic factors
- These include factors such as:
 - Temperature
 - Sunlight
 - pH (soil and water)

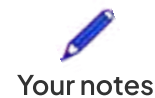

- Salinity
- Dissolved oxygen
- Soil texture
- Moisture and precipitation levels
- Minerals and nutrients
- Wind intensity
- Carbon dioxide levels (for plants)
- Changes in abiotic factors can affect the **survival** and **reproduction** of organisms, and the overall functioning of ecosystems
- Abiotic factors can be **quantified** (measured) to help determine the distribution of species in aquatic or terrestrial ecosystems

Examples of Abiotic Factors

Abiotic Factor	How it Affects Communities
Temperature	Affects the rate of photosynthesis in plants. It also affects the rate of metabolism, growth, and reproduction of organisms. Certain species have adapted to specific temperature ranges and cannot survive outside of those ranges.
Sunlight	Plants require light for photosynthesis. More light leads to an increase in the rate of photosynthesis and an increase in plant growth rates.
pH (soil and water)	pH levels affect the availability of nutrients in soil and water, influencing plant growth and the survival of aquatic organisms. Certain species are adapted to specific pH ranges.
Salinity	It affects the health and survival of aquatic organisms, particularly those that are adapted to specific salinity levels.
Dissolved oxygen	Essential for the survival of aquatic organisms, particularly fish. Low oxygen levels can lead to hypoxia and negatively impact aquatic ecosystems.
Soil texture	Influences water retention, nutrient availability, and root penetration, affecting plant growth and the distribution of soil-dwelling organisms.

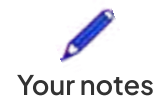

Moisture and precipitation	Determines the amount of water available to organisms, which can impact their survival, growth, and reproduction.
Minerals and nutrients	Different species of plants are adapted to different soil mineral contents and nutrient concentrations, influencing plant growth and community composition.
Wind intensity	Wind speed affects the transpiration rate in plants and can disperse seeds and pollen, influencing plant distribution and reproduction.
Carbon dioxide levels	CO ₂ is required for photosynthesis in plants. CO ₂ concentration affects the rate of photosynthesis and overall plant growth.

Ecological Niches

- A niche describes the particular set of abiotic and biotic conditions and resources to which an organism or population **responds** and upon which an organism or population **depends**
- Each individual species has its **own distinct** niche because only one species can occupy a given niche.
- If two species try to occupy the same niche, they will **compete** with each other for the same resources
 - One of the species will be more successful and out-compete the other species until only one species is left and the other is either forced to occupy a new, slightly different niche or to go extinct from the habitat or ecosystem altogether
- For example, the three North American warbler species shown below all occupy the **same habitat** (spruces and other conifer trees) but occupy **slightly different niches** as each species feeds at a different height within the trees
 - This avoids competition between the three species, allowing them to co-exist closely with each other in the same habitat



Your notes

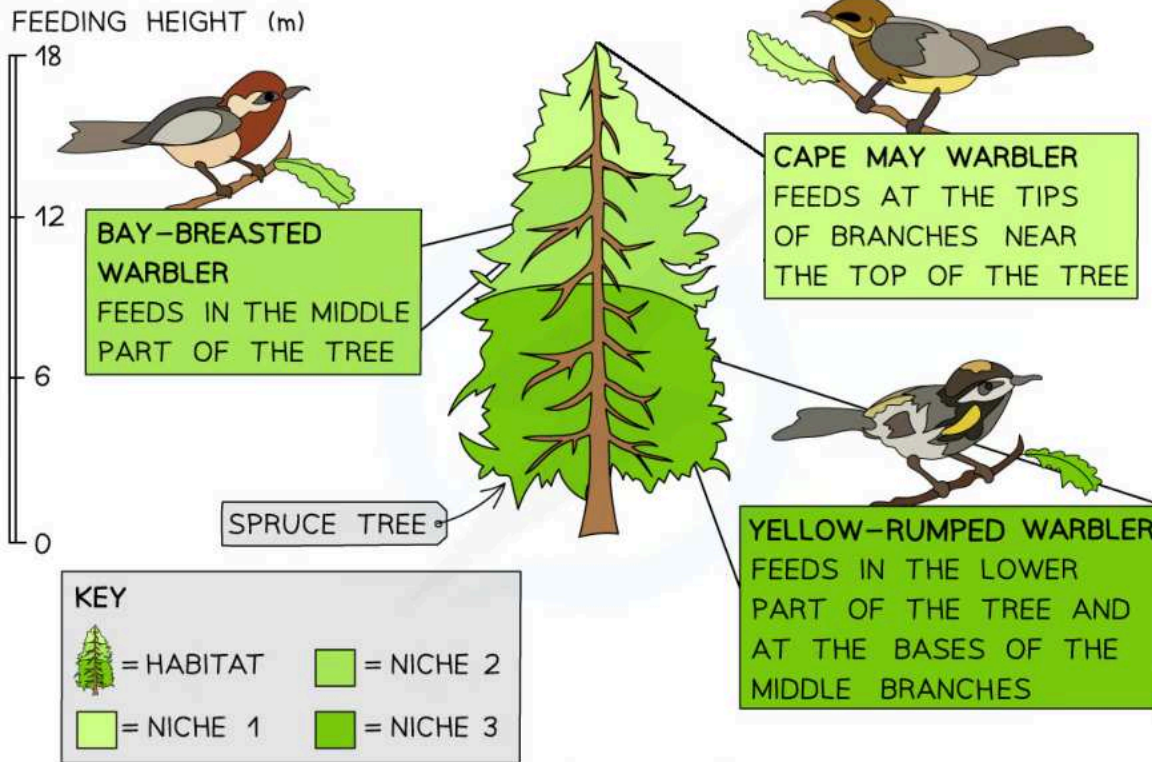

Although it appears as though these three species share the same niche, they actually spend their time feeding in different parts of spruces and other conifer trees



Examiner Tips and Tricks

It can be difficult to understand the concept of a niche. It can help to think of it as the **specific role** a species plays within its habitat, including its behaviours, the resources it consumes, and the specific places where it feeds and shelters.

Population Interactions

- A population is a group of organisms of the same species living in the **same area** at the **same time**
- Populations are **characterised** through:
 - Size
 - Density



Your notes

- Distribution
- Age structure
- Growth rate
- Interaction with each other
- Ecosystems consist of many populations of numerous different species interacting with each other
- Populations interact in ecosystems through:
 - Herbivory
 - Predation
 - Parasitism
 - Mutualism
 - Disease
 - Competition
- Resulting in ecological, behavioural and evolutionary consequences

Herbivory

- When an organism (known as an herbivore) feeds on a plant
- The carrying capacity of herbivore species is affected by the number of plants they feed on
- An area with more plant resources will have a higher carrying capacity for herbivore species
- This can have **negative feedback effects** (i.e. the carrying capacity of the herbivore species may decrease if herbivory rates are too high and the plant population decreases too much)

Predation

- When one animal eats (preys upon) another
- This lowers the carrying capacity of the prey species
- This can also have negative feedback effects, lowering the carrying capacity of the predator species due to a decrease in prey numbers
- In a stable community, the numbers of predators and prey rise and fall in **cycles**, limiting the carrying capacity of both predator and prey populations
- The graph below demonstrates some of the key patterns of predator-prey cycles:
 - The number of predators increases as more prey is available



Your notes

- The number of prey then decreases as there are now more predators
- The number of predators decreases as there is now less prey available
- The number of prey increases as there are now fewer predators
- The cycle now repeats

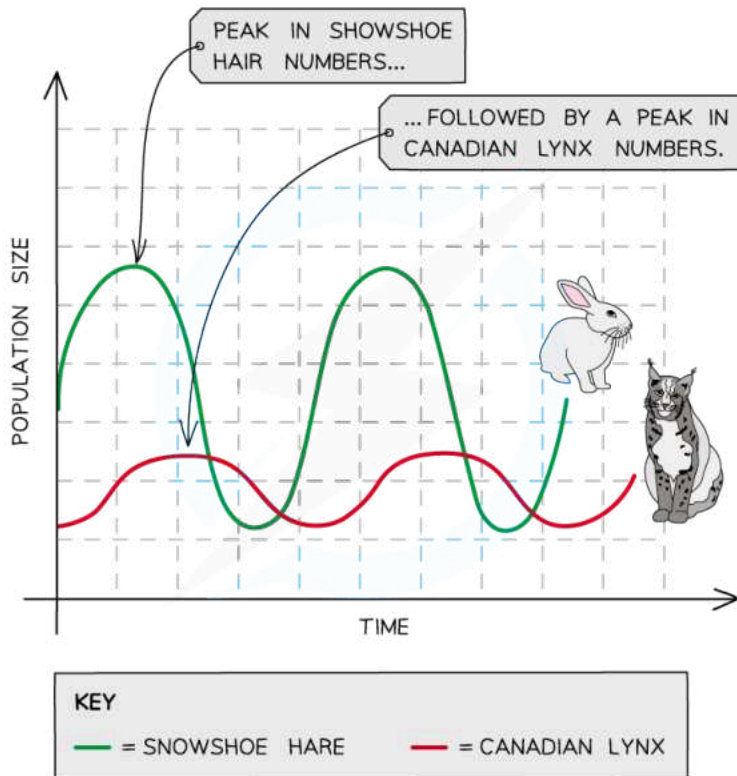

An example of a graph used to model a predator-prey cycle between the Canadian lynx and the snowshoe hare

Parasitism

- Parasites are organisms that are adapted to live very closely with another species, known as the **host** species
- A parasitic relationship is one in which the parasitic organism **benefits** from the host organism
- The parasite lives either in or on the body of the host species and gains **resources** (i.e. what it needs in order to survive) from the host, including food, shelter and a suitable location to reproduce (where offspring can feed and grow)



Your notes

- However, the host does not benefit from this relationship and parasites often harm the host in some way
- This can lower the host's carrying capacity
- An example of a parasitic relationship is fleas being parasites on mammals (e.g. dogs)—the fleas feed on the host's blood but don't provide anything to the host in return and may transmit diseases to the host
- Another example is the parasite that causes malaria
 - This parasite infects red blood cells in humans, causes recurrent episodes of fever and can be fatal in certain instances
 - The malarial parasite has a life cycle that includes the mosquito as a **vector**

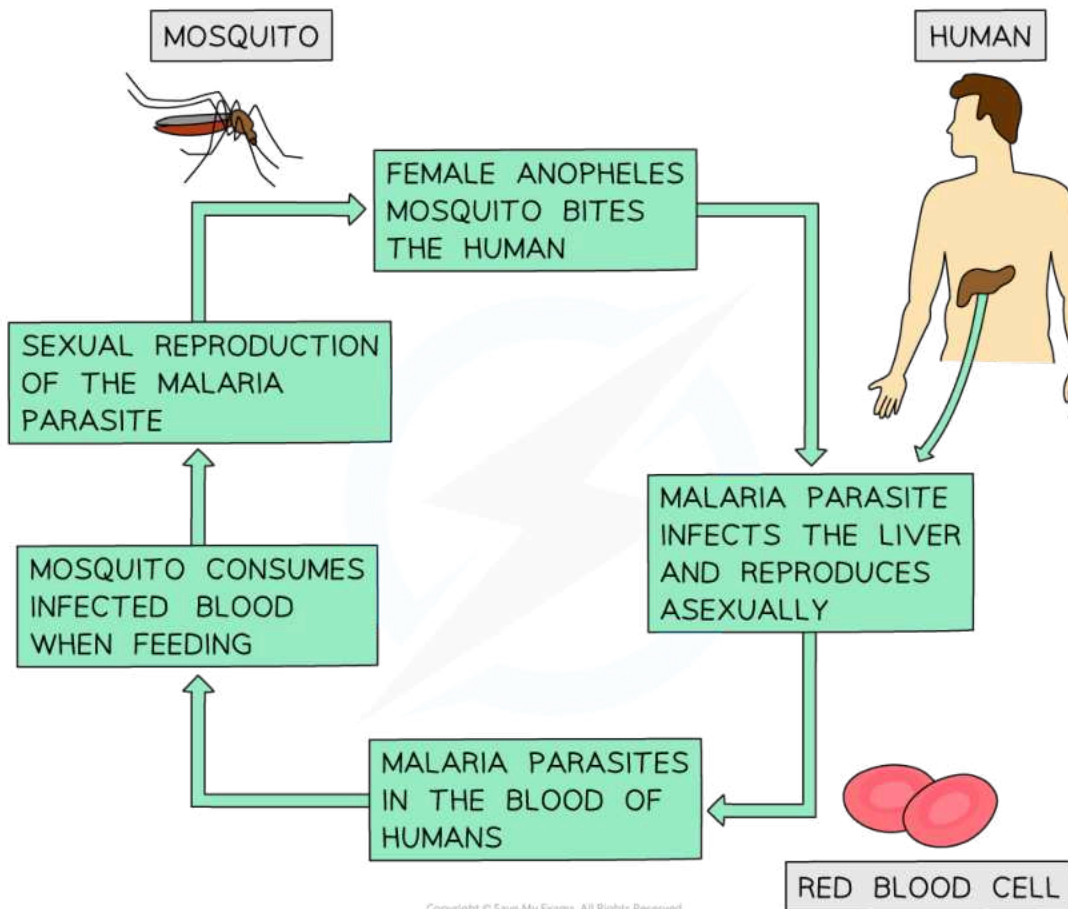

Copyright © Save My Exams. All Rights Reserved

Part of the malaria parasite's life cycle is in humans and the other part is in mosquitos

Mutualism

- A mutualistic relationship between species is one in which **both species benefit**
- This increases the carrying capacity of both species in the relationship
- An example of a mutualistic relationship is the one that exists between bees and many species of flowering plants
- Bees gain nectar (i.e. food to provide them with energy) from flowers
- When bees visit flowers, pollen is transferred to their bodies
- As bees visit multiple different flowers, they spread the pollen to these flowers, pollinating them
- In this way, the flowers gain help in **reproducing**



Your notes

Disease

- **Pathogens** (bacteria, viruses, fungi, and protozoa) are organisms that cause diseases
- These diseases lower the carrying capacity of the species that the pathogens infect
- Changes in the incidence of diseases can cause populations to **fluctuate** around their carrying capacity

Competition

- Competition can be divided into **intraspecific** competition (competition between members of the same species) and **interspecific** competition (competition between members of different species)
 - Intraspecific competition can lower the carrying capacity of a population due to a **decrease in food availability** caused by high population density
 - Interspecific competition occurs between species with **similar niches**, causing a decrease in the carrying capacity of one or both species



Your notes

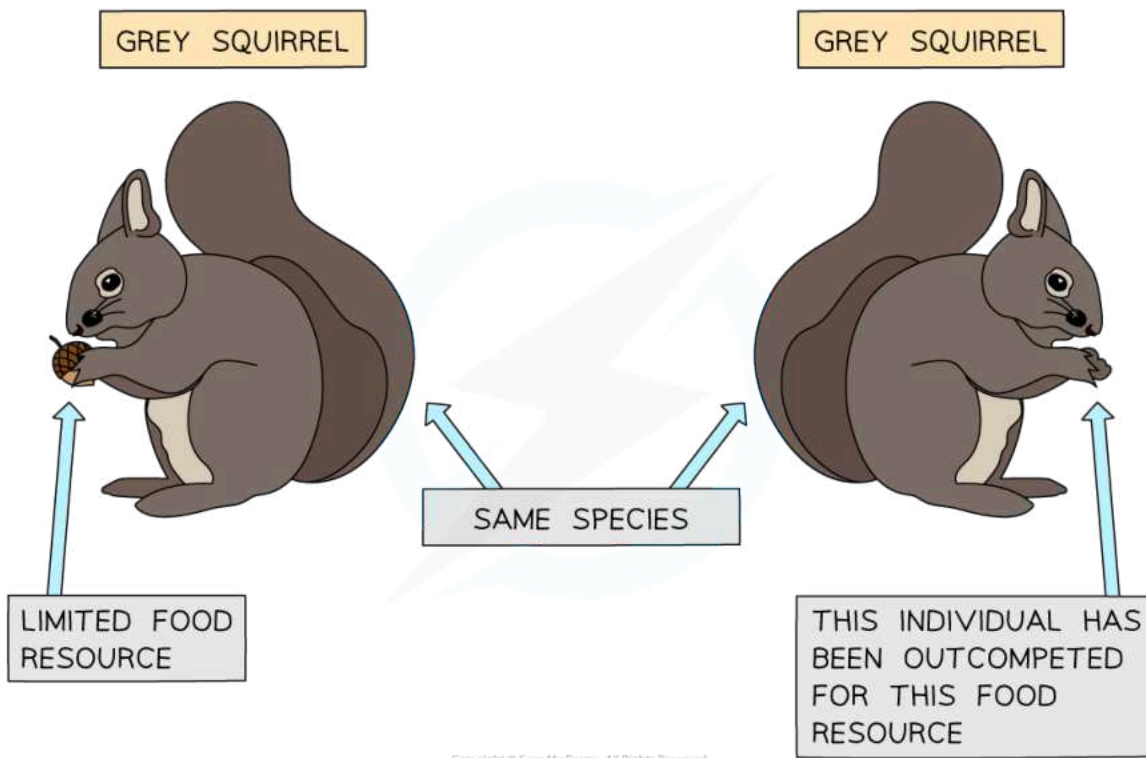

Copyright © Save My Exams. All Rights Reserved

Intraspecific competition between two grey squirrels (same species) for a limited resource



Your notes

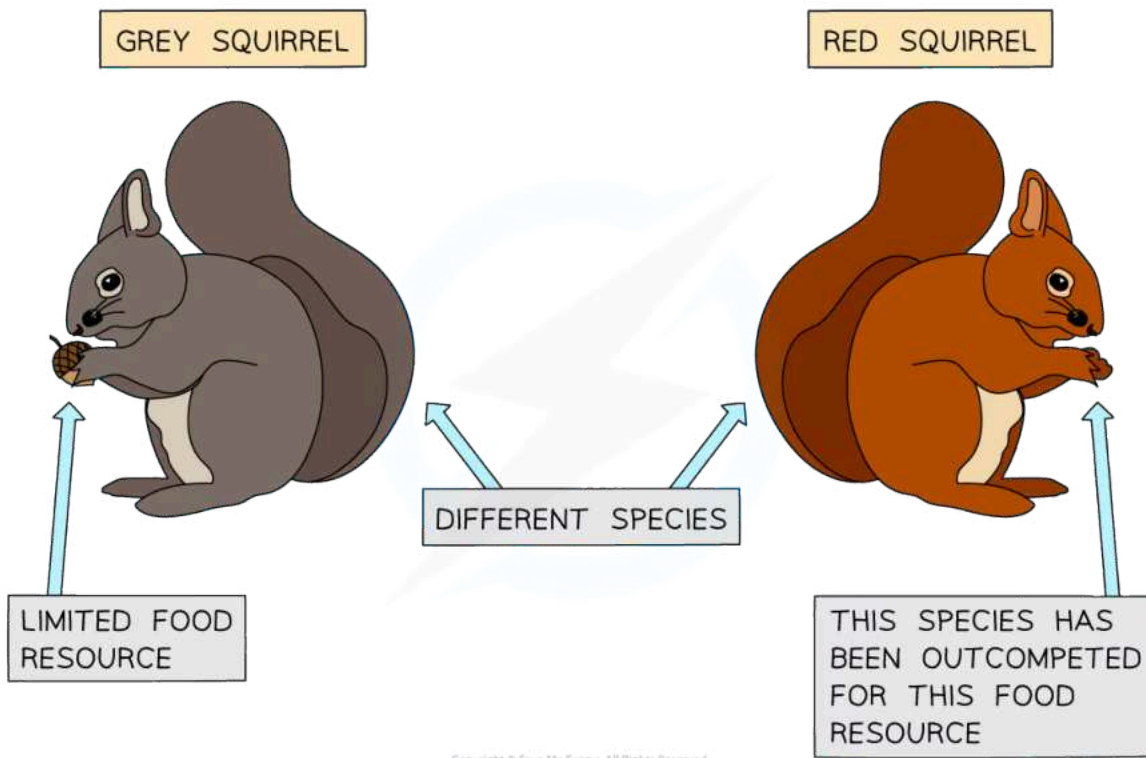

Interspecific competition between a grey squirrel and a red squirrel (different species) for a limited resource



Your notes

Population Growth

Carrying Capacity

- The **maximum stable population size** of a species that an ecosystem can **support** (determined by competition for limited resources) is known as the **carrying capacity**
- Every individual within a species population has the **potential to reproduce** and have **offspring** that will contribute to **population growth**
 - In reality, however, there are many abiotic and biotic factors that **prevent** every individual in a population from making it to adulthood and reproducing
- This ensures the population size of each species is **limited** at some point (i.e. the carrying capacity of that species is reached)
 - This is why no single species has a population size that dominates all other species populations on Earth, with the exception of humans (as we have managed to **overcome** many of the abiotic and biotic factors that could potentially limit the population growth of our species)
- The graph below shows the population growth of a population of lions
 - The point at which the graph starts to flatten out (plateau) is the carrying capacity of this population
 - At this point, the environmental (abiotic and biotic) factors that stop individuals from surviving and reproducing result in the population no longer being able to grow in size

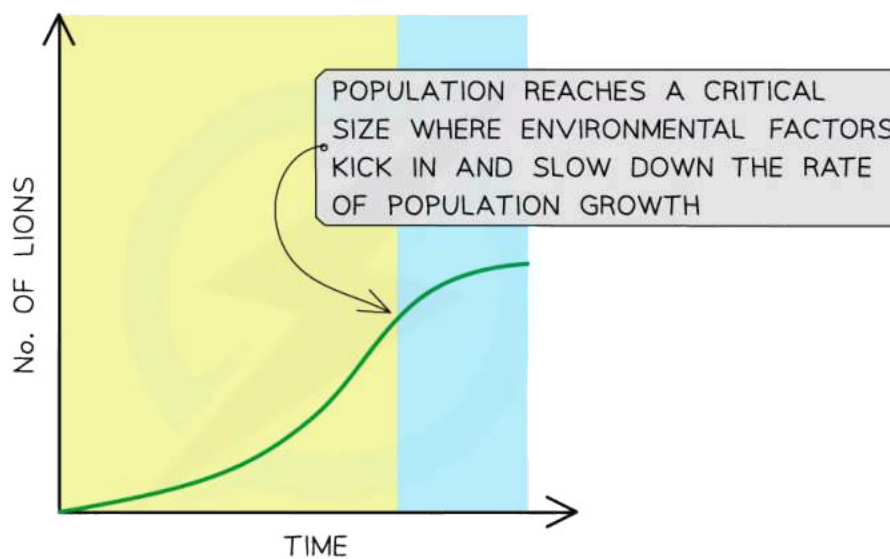

Copyright © Save My Exams. All Rights Reserved

An example graph showing the population growth of a population of lions and the point at which the carrying capacity of this population has almost been reached



Your notes

Density-dependent Factors & Negative Feedback Mechanisms

- Population size is regulated by density-dependent factors and negative feedback mechanisms
- Density-independent factors may influence population size
 - For example, environmental conditions like climate, temperature, rainfall patterns and soil fertility can limit the size of a population
- However, it is mainly **density-dependent factors** that regulate populations around the carrying capacity
 - Density-dependent factors are factors whose impact on population size varies with the population's density

Density-dependent factors

- Competition for resources:**
 - As population density increases, individuals compete more intensely for limited resources like food, water and shelter
 - For example, in a forest ecosystem, as deer population density rises, competition for available food (grass, leaves, etc.) increases, placing limits on individual growth rates and overall population size
- Increased risk of predation:**
 - Higher population density increases the likelihood of predators encountering prey, leading to more predation events
 - For example, in a coral reef ecosystem, as fish populations grow denser, predation by larger fish species also increases, regulating the population size of smaller fish species
- Pathogen transmission:**
 - Dense populations facilitate the spread of pathogens, such as diseases and parasites, leading to increased mortality rates
 - For example, in a population of bats living in a cave, as population density increases, close contact between individuals facilitates the transmission of pathogens—this increased pathogen transmission can lead to higher mortality rates among bats, regulating the population size



Your notes

Negative feedback mechanisms

- Density-dependent factors drive negative feedback mechanisms, which act to return a population to its **equilibrium state**, maintaining stability
 - As population density rises, factors like resource scarcity, increased predation and disease outbreaks trigger mechanisms that reduce population growth rates

Population Growth Curves

- Population growth can either be **exponential** or **limited by carrying capacity**
 - If there are no limiting factors, population growth follows a J-curve (exponential growth)
 - When density-dependent limiting factors start to operate, the curve becomes S-shaped

J-curves

- For some populations, when population growth is plotted against time, a J-curve is produced
 - A J-curve describes the growth pattern of a population in an environment with **unlimited resources**
- The J-curve has three distinct phases:
 1. **Lag phase:**
 - The initial growth is slow when the population is small
 2. **Exponential growth phase:**
 - Population growth accelerates exponentially as the number of individuals increases
 - The curve takes a J-shape due to exponential growth, as resources are not limiting the growth of the population
 - The population will continue to grow until a limiting factor such as disease or predation occurs
 3. **Crash phase:**
 - At this point, if there has been a significant population overshoot (if the population has increased far beyond the natural carrying capacity), there may be a sudden decrease in the population, known as a population crash



Your notes

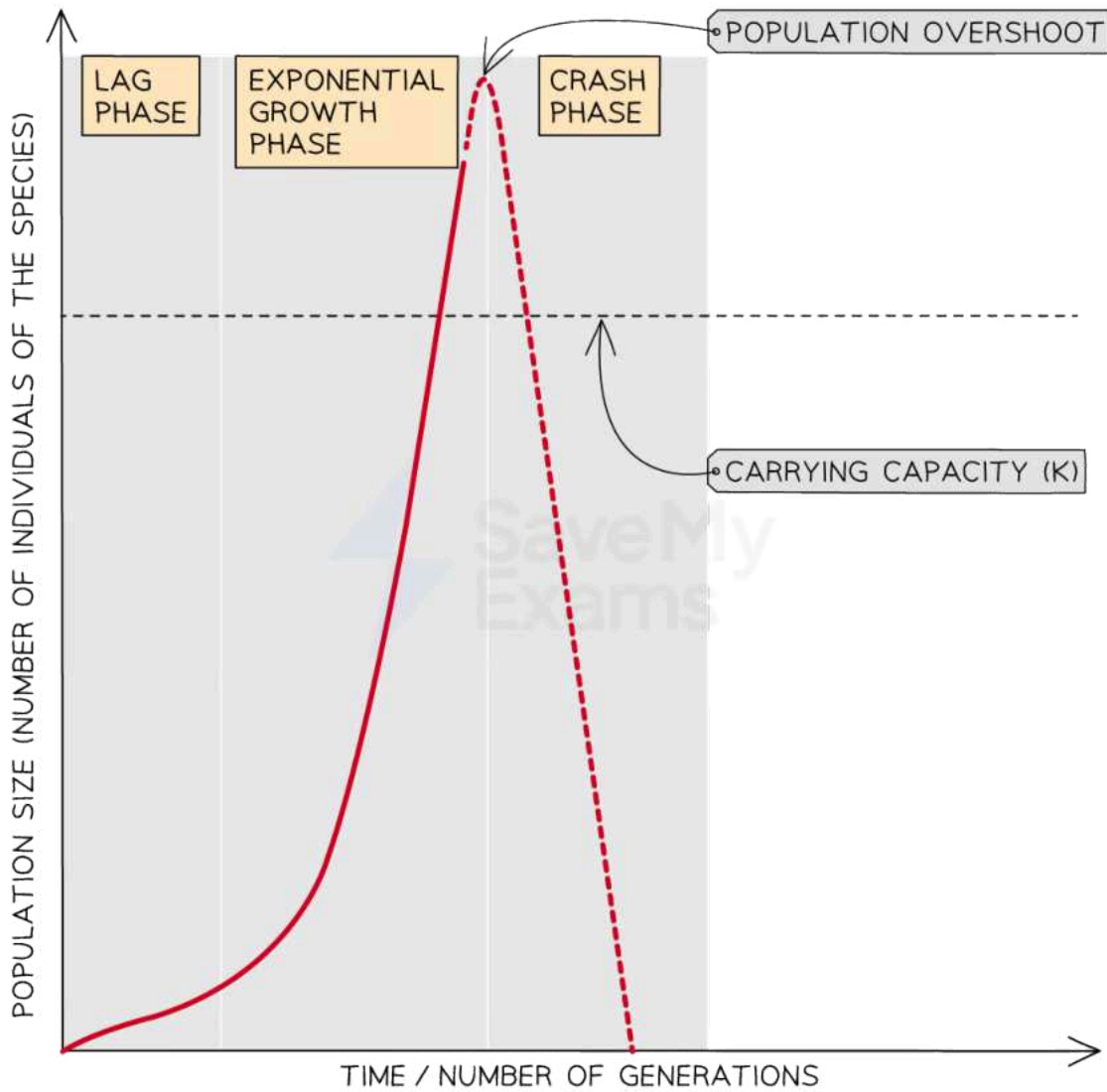

Copyright © Save My Exams. All Rights Reserved

A J-population curve describes the growth pattern of a population in an environment with unlimited resources

S-curves

- For most populations, when population growth is plotted against time, an S-population curve is produced
 - An S-population curve describes the growth pattern of a population in a **resource-limited environment**
- The S-population curve has four distinct phases:



Your notes

1. Lag phase:

- The initial growth is slow when the population is small

2. Exponential growth phase:

- With low or reduced limiting factors, the population expands exponentially into the habitat

3. Transitional phase:

- As the population grows, there is increased competition between individuals for the same limiting factors or resources
- This competition results in a lower rate of population increase

4. Plateau phase:

- The population reaches its carrying capacity and fluctuates around a set point determined by the limiting factors
- Changes in limiting factors cause the population size to increase and decrease (these increases and decreases around the carrying capacity are controlled by negative feedback mechanisms)



Your notes

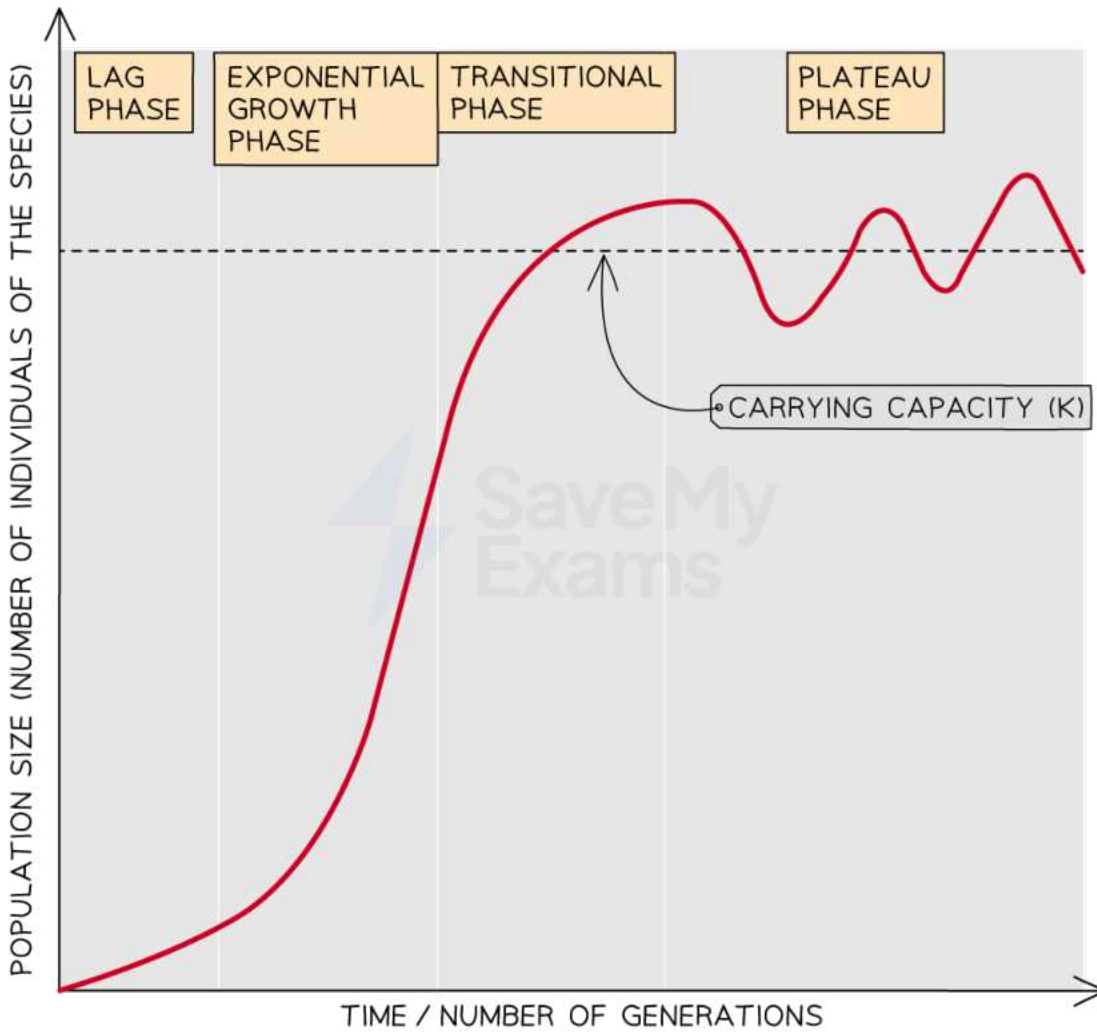

Copyright © Save My Exams. All Rights Reserved

An S-population curve describes the growth pattern of a population in a resource-limited environment



Your notes

Studying Populations

Sampling Strategies

Populations and samples

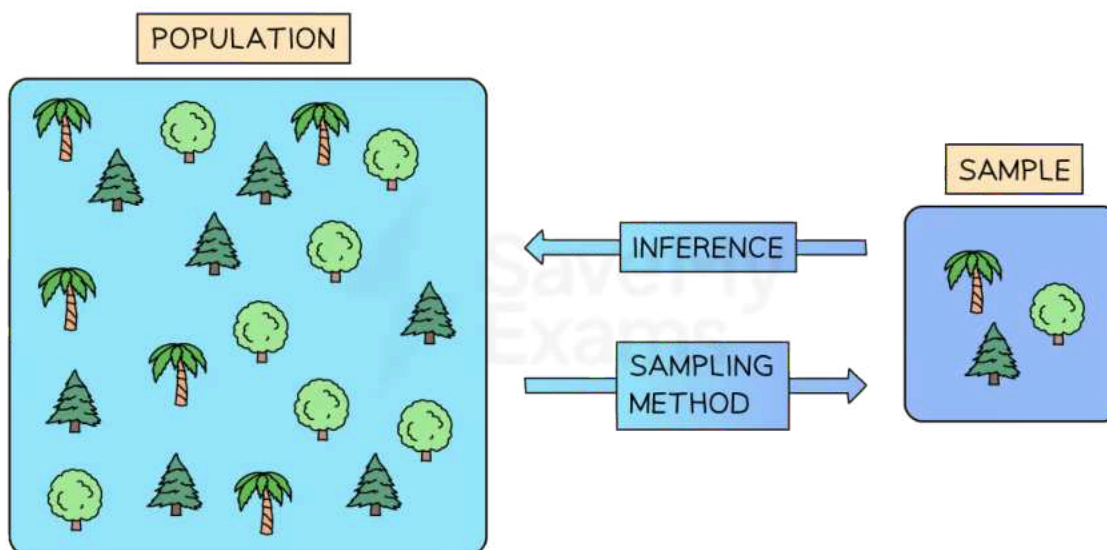

Copyright © Save My Exams. All Rights Reserved

Sampling methods are used to extract a smaller sample from a larger population – inferences (i.e. conclusions) can then be made about the population by analysing the sample data

What is a population?

- A population refers to the **whole set** of things that you are interested in
 - e.g. if a teacher wanted to know how long pupils in year 11 at their school spent revising each week then the population would be **all** the year 11 pupils at the school
- Population does not necessarily refer to a number of people or animals
 - e.g. if an IT expert wanted to investigate the speed of mobile phones then the population would be all the different makes and models of mobile phones in the world

What is a sample?

- A sample refers to a **selected part** (i.e. a **subset**) of the population that data is collected from
 - e.g. for the teacher investigating year 11 revision times, a sample would be a certain number of pupils from year 11



Your notes

- A **random sample** is where every item in the population has an **equal chance** of being selected
 - e.g. every pupil in year 11 would have the same chance of being selected for the teacher's sample
- A **biased** sample is where the sample is **not random**
 - e.g. the teacher asks pupils from just one class

What are the advantages and disadvantages of using a population?

- You may see or hear the word census - this is when data is collected from every member of the whole population
- The advantages of using a population include:
 - **Accurate results** - as every member/item of the population is used
 - All options/opinions/responses will be included in the results
- The disadvantages of using a population include:
 - **Time consuming** to collect the data
 - **Expensive** due to the large numbers involved
 - **Large amounts of data** to organise and analyse

What are the advantages and disadvantages of using a sample?

- The advantages of using a sample include:
 - **Quicker** to collect the data
 - **Cheaper** as not so much work involved
 - **Less data** to organise and analyse
- The disadvantages of using a sample include:
 - A small sample size can lead to **unreliable results**
 - Sampling methods can usually be improved by taking a larger sample size
 - A sample can introduce **bias**
 - Particularly if the sample is **not random**
 - A sample might not be **representative** of the population
 - Only a selection of options/opinions/responses might be accounted for
 - The members/items used in the sample may all have similar responses



Your notes

- e.g. even with a random sample, it may be possible that the teacher happens to select pupils for their sample who all happen to do very little revision
- It is important to recognise that **different samples** (from the same population) may produce **different results**

Random and systematic sampling strategies

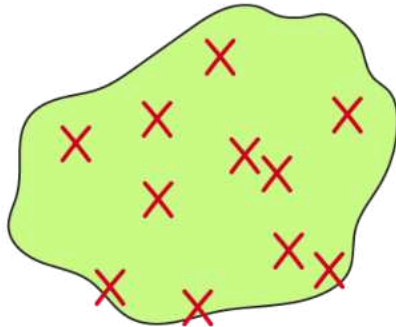

RANDOM SAMPLE SITES

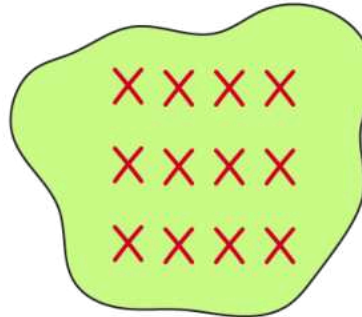

SYSTEMATIC SAMPLE SITES

Random sampling differs from systematic sampling when choosing sample sites for an area of land

- There are two different types of sampling:
 - **Random**
 - **Systematic**
- In random sampling, the positions of the sampling points are completely random or due to **chance**
 - For example, sampling points can be selected using a random number generator to create a set of random coordinates
 - This method is beneficial because it means there will be **no bias** by the person who is carrying out the sampling that may affect the results (i.e. there will be **no researcher bias**)
 - Random sampling can be used when the population size or the individual sample size is relatively small, and all individuals have an equal chance of being sampled
- In systematic sampling, the positions of the sampling points are **chosen** by the person carrying out the sampling and a **regular pattern** is used to select sample points
 - There is a possibility that the person choosing could show bias towards or against certain areas
 - Individuals may deliberately place the quadrats in areas with the least species as these will be easier and quicker to count
 - This is unrepresentative of the whole area



Your notes

- When a sampling area is reasonably **uniform** or has **no clear pattern** to the way the species are distributed, random sampling is the best choice

Transect sampling

- Systematic sampling allows researchers to investigate the effect of the presence of certain environmental features on species distribution e.g. by taking samples along a line that extends away from, or along, an environmental feature, such as a river
 - A line of this type is known as a **transect**
- Transect sampling is used when there is a clear change in the physical conditions across the area being studied
 - For example, there may be changes in altitude, soil pH or light intensity
 - Methods using transects can help show how species distribution changes with the different physical conditions in the area
 - A transect is a line represented by a measuring tape, along which samples are taken
- For a **line transect**:
 - Lay out a measuring tape in a straight line across the sample area
 - At equal distances along the tape, record the identity of the organisms that touch the line (e.g. every 2 m)
- For a **belt transect**:
 - Place quadrats at regular intervals along the tape and record the abundance or percentage cover of each species within each quadrat

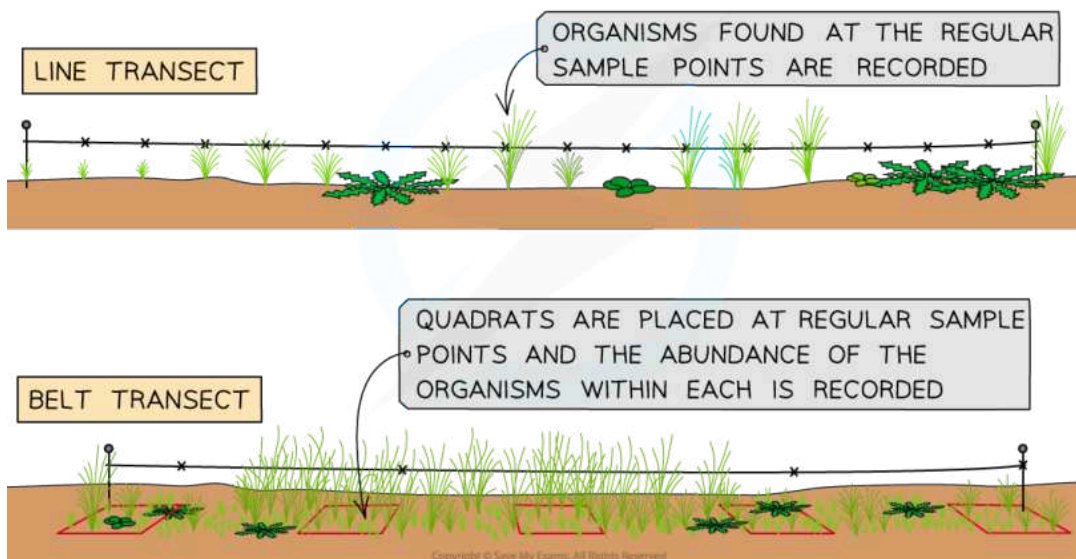



Your notes

A line transect and belt transect is carried out in a habitat

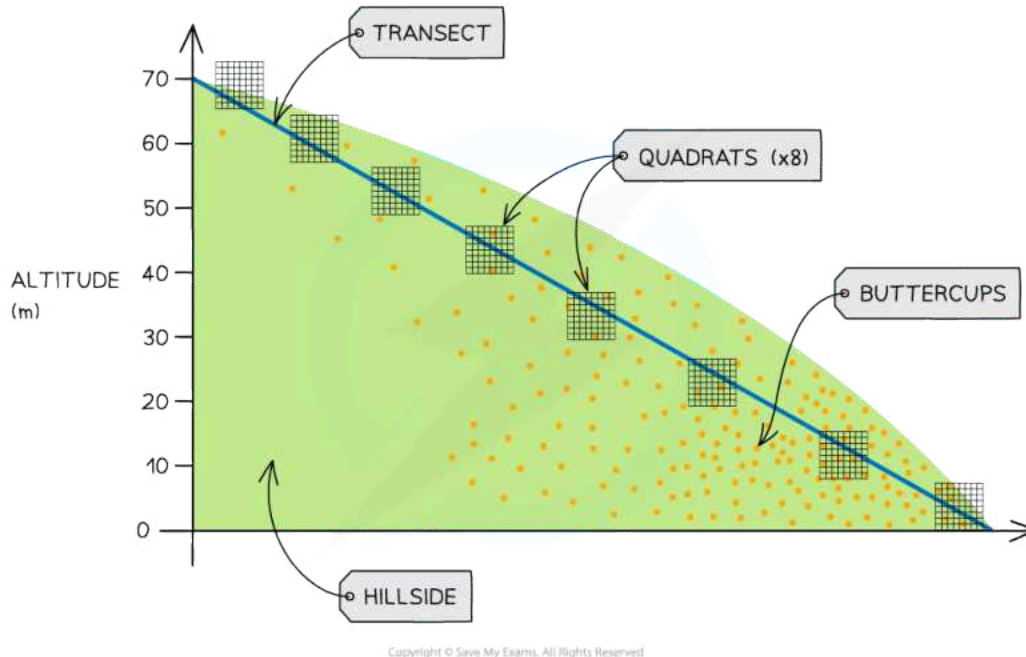

An example of a belt transect on a hillside—quadrat is placed at regular intervals (every 10 m of altitude gained) and the number of individuals (of the species being investigated e.g. buttercups) in each quadrat is recorded

Quadrat Sampling

- Quadrats are square frames made of wood or wire
- They can be a variety of sizes e.g. 0.25 m² or 1 m²
- They are placed on the ground and the organisms within them are recorded
- Non-motile organisms such as plant species are commonly studied using random quadrat sampling to estimate their population size
- Quadrats can be used to estimate population size by recording:
 - The number of an individual species: the total number of individuals of a single species (e.g. daisies) is recorded
 - Percentage cover: the approximate percentage of the quadrat area in which an individual species is found is recorded (this method is often used when it is difficult to count individuals of the plant species being recorded eg. grass or moss)



Your notes

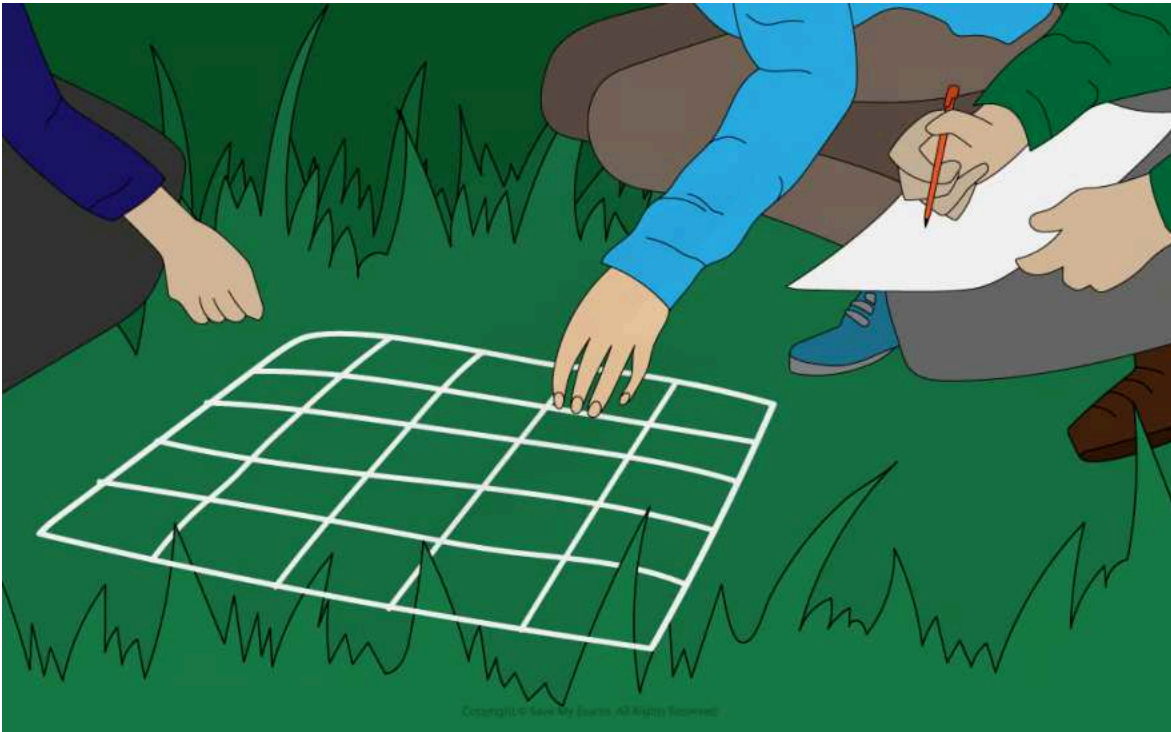

Using a quadrat to estimate population size

Estimating population size

- Quadrats must be laid randomly in the area to avoid sampling bias
 - This random sampling can be done by converting the sampling area into a grid format and labelling each square on the grid with a number
 - Then a random number generator is used to pick the sample points
- Once the quadrat has been laid on the chosen sample point the abundance of all the different species present can be recorded



Your notes

ESTIMATING POPULATION SIZE METHOD

1 USE TWO TAPE MEASURES TO LAY OUT A SURVEY AREA (e.g. 10 m x 10 m) IN YOUR CHOSEN HABITAT, SUCH AS THE SCHOOL FIELD.

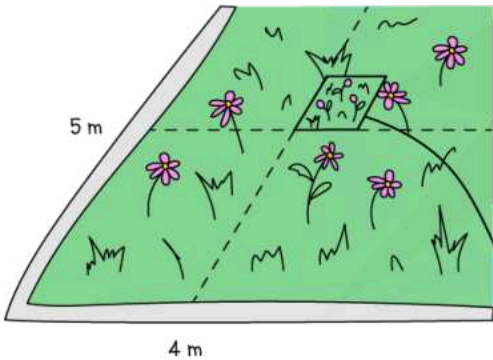
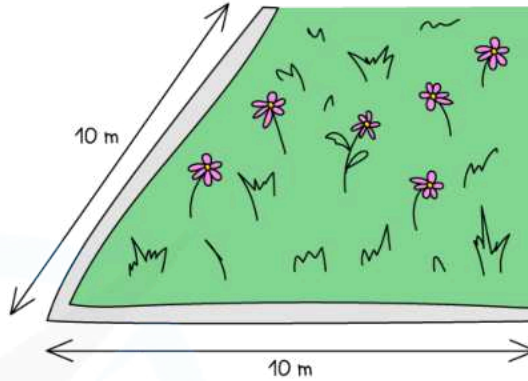

2 USE A RANDOM NUMBER GENERATOR TO CREATE A SET OF COORDINATES TO PLACE YOUR FIRST QUADRAT. e.g. IF YOU GET A 4 AND A 5, PLACE YOUR QUADRAT 4 m ALONG THE x-AXIS AND 5 m ALONG THE y-AXIS.

3 COUNT THE NUMBER OF YOUR CHOSEN PLANT SPECIES (e.g. DANDELIONS) THAT ARE FOUND WITHIN THIS QUADRAT.

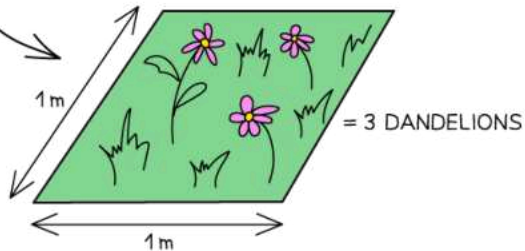



Your notes

Quadrat	Number of dandelions
1	3
2	4
3	2
4	1
5	0
6	0
7	2
8	5
9	3
10	1
Total	21

4 RECORD THIS NUMBER IN A RESULTS TABLE AND REPEAT STEPS 1-3 UNTIL YOU HAVE RECORDED THE NUMBER OF YOUR CHOSEN PLANT SPECIES IN 10 QUADRATS.

5 ESTIMATE THE POPULATION OF DANDELIONS IN YOUR SURVEY AREA USING THE EQUATION:

$$\text{ESTIMATED POPULATION SIZE} = \frac{\text{TOTAL AREA}}{\text{AREA SAMPLED}} \times \text{TOTAL NUMBER OF DANDELIONS COUNTED}$$

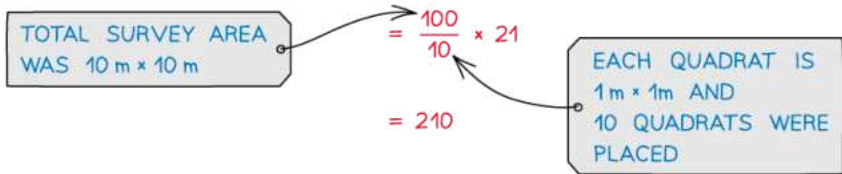

Copyright © Save My Exams. All Rights Reserved

How to estimate the population size of a plant species in a survey area

Estimating percentage cover and percentage frequency

- Percentage cover is an estimate of the area within a given quadrat covered by the plant or animal being sampled



Your notes

- Percentage frequency is the number of squares in which the species occurs divided by the number of possible occurrences

$$\% \text{ frequency} = \left(\frac{\text{number of quadrat squares in which species present}}{\text{total number of quadrat squares}} \right) \times 100$$

- This can be useful, as it can sometimes be **difficult to count individual plants or organisms** within a quadrat
- For example, if grass is found in 89 out of 100 squares in the quadrat then it has a percentage frequency of 89%
 - This process could be repeated for a series of quadrats within a given sample area
 - This information could then be used to calculate the average percentage cover across all the sampled quadrats

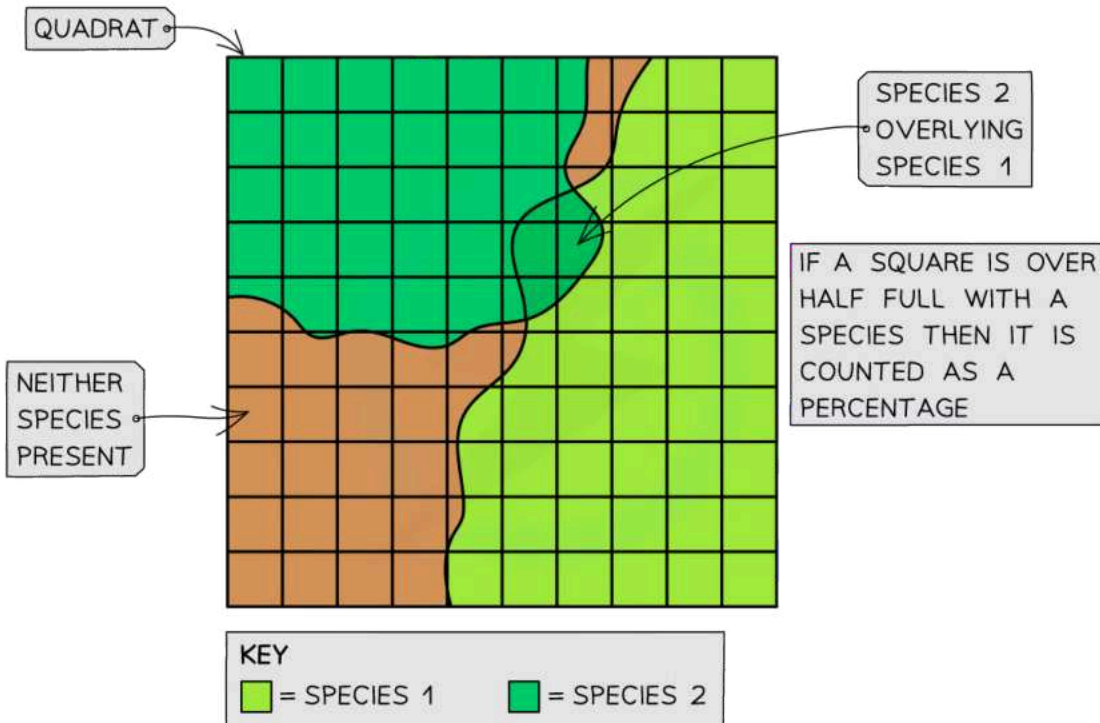

Using a quadrat to investigate percentage cover of two species of grass—there may be some squares lacking any species and other squares with multiple species



Your notes

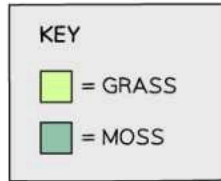
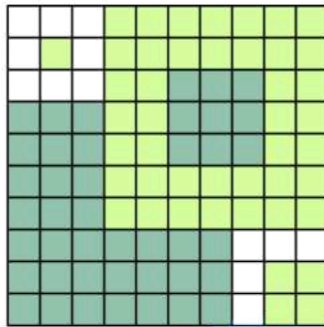

PROCESS

CALCULATIONS

STEP 1: COUNT THE NUMBER OF SQUARES COVERED BY GRASS

STEP 2: CALCULATE THIS AS A PERCENTAGE (DIVIDE THE NUMBER OF SQUARES COVERED BY GRASS BY THE TOTAL NUMBER OF SQUARES IN THE QUADRAT, THEN MULTIPLY THIS BY 100)

STEP 3: REPEAT THIS PROCESS FOR MOSS

GRASS COVERS 45 SQUARES

$$45 \div 100 = 0.45$$

$$0.45 \times 100 = 45\%$$

 PERCENTAGE COVER OF GRASS = 45%

MOSS COVERS 42 SQUARES

$$42 \div 100 = 0.42$$

$$0.42 \times 100 = 42\%$$

 PERCENTAGE COVER OF MOSS = 42%

Copyright © Save My Exams. All Rights Reserved

How to estimate the percentage frequency of one or more species using a quadrat



Examiner Tips and Tricks

It is important to note that percentage cover and frequency give an estimate of abundance but not actual population size.

Capture-mark-release-recapture & the Lincoln Index

- The sampling methods described above are only useful for non-motile (sessile) organisms



Your notes

- Different methods are required for estimating the number of individuals in a population of motile animals (i.e. animals that are mobile)
- The capture-mark-release-recapture method is commonly used alongside the Lincoln index (a statistical measure used to estimate population size)
- The Lincoln index can be used to estimate the **abundance** or **population size** of a species in a **given area**
 - First, the capture-mark-release-recapture technique is carried out
- For a single species in the area:
 - The first large sample is taken—as many individuals as possible are caught, **counted** and **marked** in a way that won't affect their survival e.g. if studying a species of beetle, a small amount of brightly coloured non-toxic paint can be applied to their carapace (shell)
 - The marked individuals are returned to their habitat and allowed to **randomly mix** with the rest of the population
 - When a sufficient amount of time has passed another large sample is captured
 - The number of marked and unmarked individuals within the sample are counted
 - The **proportion of marked to unmarked individuals** is used to calculate an estimate of the population size (the Lincoln index)
- The formula for calculating the Lincoln index is:
$$\text{Population size estimate} = (M \times N) \div R$$
- Where:
 - M = number of individuals caught in the first sample (i.e. number of marked individuals released)
 - N = number of marked and unmarked individuals caught in the second sample (i.e. total number of individuals recaptured)
 - R = number of marked individuals in the second sample (i.e. number of marked individuals recaptured)



Worked Example

Scientists wanted to investigate the abundance of leafhoppers in a small grassy meadow. They used sweep nets to catch a large sample of leafhoppers from the meadow. Each insect was marked on its underside with non-toxic waterproof paint and then released back into the meadow. The following day another large sample was caught using sweep nets. Use the figures below to estimate the size of the leafhopper population in this meadow.

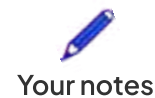

- Number caught and marked in first sample (M) = 236
- Number caught in second sample (N) = 244
- Number of marked individuals in the second sample (R) = 71

Answer

Step One: Write out the equation and substitute in the known values

$$N = (M \times N) \div R$$

$$N = (236 \times 244) \div 71$$

Step Two: Calculate the population size estimate (N)

$$N = 57\,584 \div 71$$

$$N = 811$$

Estimated population size = 811

Limitations of using the capture-mark-release-recapture method

- When using the mark-release-capture method, there are a few assumptions that have to be made:
 - The marked individuals must be given sufficient time to disperse and mix back in fully with the main population - this can be time-consuming
 - The marking doesn't affect the survival rates of the marked individuals (e.g. doesn't make them more visible and therefore more likely to be predated)
 - The marking remains visible throughout the sampling and doesn't rub off - this is often difficult to ensure and so the accuracy of population size estimates may be negatively affected
 - The population stays the same size during the study period (i.e. there are no significant changes in population size due to births and deaths and there are no migrations into or out of the main population) - again, this is almost impossible to ensure, further affecting the accuracy of population size estimates

Ecosystem Functioning & Sustainability



Your notes

Ecosystem Functioning & Sustainability

Sustainability of ecosystems

- Sustainability is a fundamental property of ecosystems
 - It refers to the ecosystem's ability to maintain **balance** and **productivity** over time
 - Ecosystems naturally **regulate themselves** to sustain life within them

Balanced inputs and outputs

- In a steady-state ecosystem, inputs and outputs are balanced
 - Inputs include energy, nutrients and water entering the ecosystem
 - Outputs include energy, nutrients and waste leaving the ecosystem
 - This balance ensures the ecosystem's long-term **stability** and **resilience**
- These inputs and outputs can be illustrated with **ecosystem flow diagrams**
 - Flow diagrams demonstrate the movement of energy and nutrients within ecosystems
 - These diagrams highlight the interconnectedness of **biotic** and **abiotic** factors within an ecosystem



Your notes

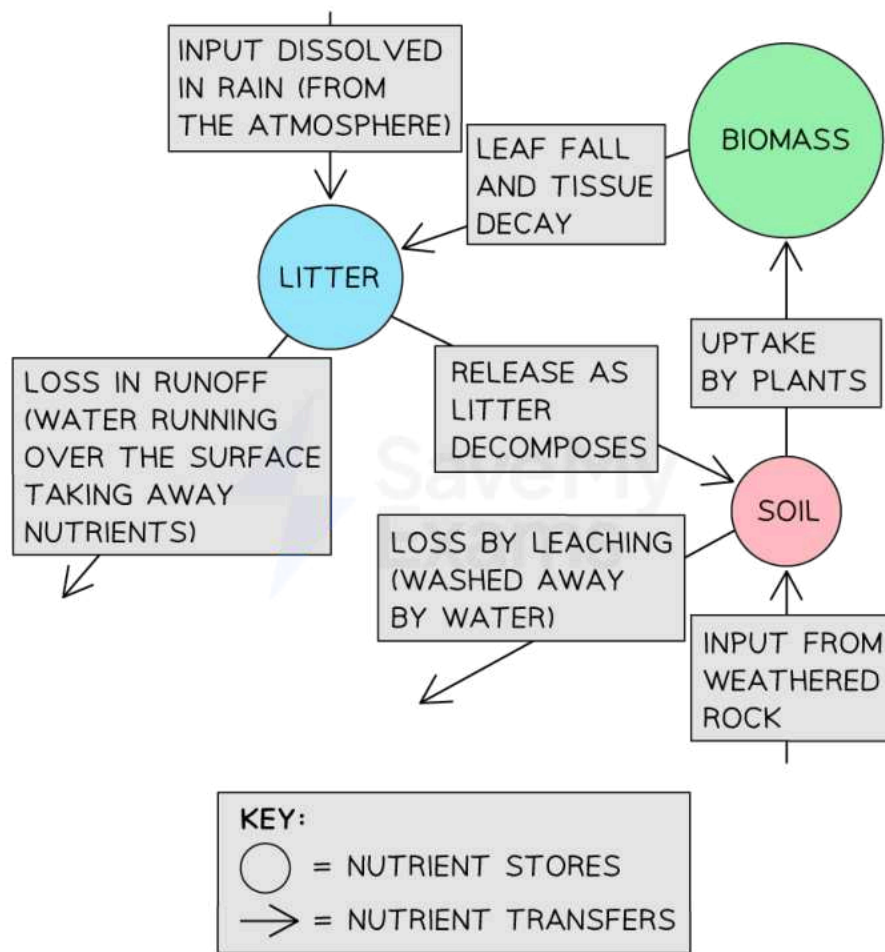

Copyright © Save My Exams. All Rights Reserved

Tropical Rainforest Ecosystem Nutrient Flow

An ecosystem flow diagram showing a simplified form of the nutrient cycle in a tropical rainforest

Evidence of long-term sustainability

- Some ecosystems have persisted for millions of years, indicating their long-term resilience and sustainability
 - Tropical rainforests are a prime example of long-term sustainable ecosystems
 - Despite changes in climate and other external factors, these ecosystems have endured
 - For example, the Amazon Rainforest has remained stable despite external pressures like deforestation
 - Its great biodiversity and complex interactions contribute to its resilience



Your notes

Human impacts on ecosystem stability

- Human activity can **disrupt** the stability of ecosystems, leading to **tipping points**
 - Tipping points are critical **thresholds** where small changes can trigger significant **shifts** in the ecosystem
 - These shifts can lead to the collapse of the original ecosystem and the establishment of a **new equilibrium**

Deforestation in the Amazon Rainforest

- Deforestation involves the clearing of trees for agriculture, logging, or urban development
 - Deforestation reduces the generation of water vapour by plants through transpiration
- Impact on climate:**
 - Reduced transpiration leads to a decrease in the amount of water vapour in the **local atmosphere**
 - Water vapour is essential for **cloud formation** and **precipitation** (which generates a significant **cooling effect**) and for maintaining regional climate patterns
 - Consequently, deforestation disrupts local and regional climate systems
- Feedback loop:**
 - Deforestation can create a positive feedback loop where reduced precipitation leads to further forest loss
 - With less precipitation, the remaining forest may become more susceptible to **drought** and **wildfires**, accelerating deforestation and, as a result, generating even less transpiration and water vapour for precipitation
- New equilibrium:**
 - If deforestation continues at its current rate, it may not be long until the Amazon Rainforest reaches a new equilibrium state
 - This new equilibrium may feature different compositions of species, reduced biodiversity and very different climate patterns



Your notes

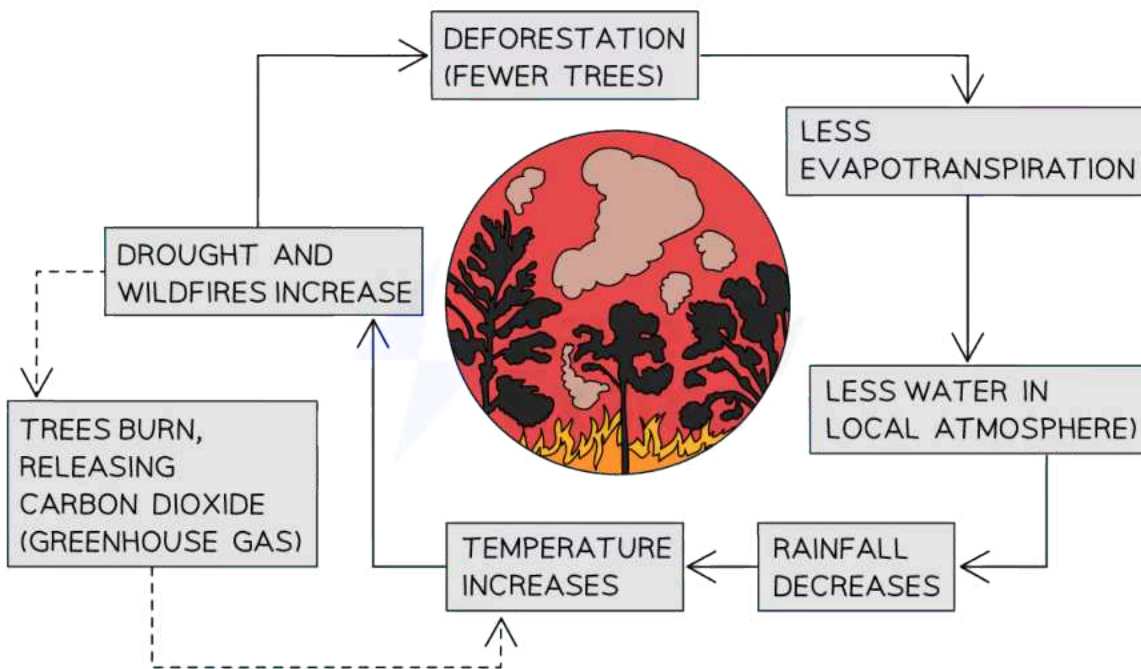

Copyright © Save My Exams. All Rights Reserved

Deforestation Feedback Loop

Deforestation can drive a positive feedback loop that results in an increase in the frequency of droughts and forest fires

Understanding the role of keystone species

- Keystone species are organisms within an ecosystem that have a disproportionately large impact on the structure and function of the ecosystem **relative to their abundance**
 - In other words, even if they have a relatively low abundance, keystone species play critical roles in maintaining the **health** and **long-term stability** of ecosystems
 - The presence of keystone species can help regulate the population sizes of other species and maintain higher levels of biodiversity
 - The removal of keystone species can have cascading effects throughout the ecosystem, leading to significant changes in community structure and function
 - If their removal disrupts the ecological balance too much, this can increase the risk of ecosystem collapse

Examples of keystone species

- Purple sea stars (*Pisaster ochraceus*) play a crucial role in controlling mussel populations along the rocky shores of the North Pacific coast
 - Sea stars prey on mussels, preventing them from overwhelming the ecosystem
 - Without sea stars, mussel populations would expand rapidly and start to **dominate** the ecosystem, **outcompeting** other species for space and resources
 - This would displace other intertidal organisms, leading to a **decline in overall species diversity**
- African elephants (*Loxodonta africana*) play a vital role in shaping the structure and composition of savannah grasslands
 - Elephants feed on shrubs and trees, preventing them from becoming too dense and dominating the landscape
 - Their browsing behaviour creates gaps in the vegetation, promoting the growth of grasses and **increasing habitat diversity**—this provides habitats for a greater variety of species, increasing species diversity
 - Their movement and feeding activities also contributes to **soil nutrient cycling** by redistributing nutrients and increasing soil fertility and plant growth



Your notes



Your notes



A cluster of purple sea stars (*Pisaster ochraceus*) at Salt Spring Island, British Columbia, Canada (photo from Wikimedia Commons)

Human impacts on biosphere integrity

- The [planetary boundaries model](#) identifies nine key Earth system processes essential for maintaining a stable planet
 - These boundaries represent safe operating limits for human activity to prevent irreversible environmental changes
 - Changes beyond these boundaries can lead to detrimental effects on Earth's systems and human well-being
- **Biosphere integrity** (one of the nine critical processes) refers to the overall health and diversity of life on Earth
 - Human activity has significantly impacted biosphere integrity, pushing it beyond critical thresholds

- Disturbances to ecosystems have led to severe **loss of biodiversity**, disrupting ecological balance and resilience
- Ecosystems and species diversity are highly **interlinked**, with each depending on the other:
 - Healthy ecosystems support diverse species populations, while diverse communities contribute to ecosystem resilience and stability
 - Loss of biodiversity due to human activities undermines the integrity of ecosystems, making them more vulnerable to collapse



Your notes

Evidence from extinction rates

- Extinction rates provide tangible evidence that the **planetary boundary** for biosphere integrity has been **crossed**
 - Highly accelerated rates of species extinction in recent times indicate severe disturbances to ecosystems and loss of biodiversity
 - Human-induced factors such as habitat destruction, pollution and climate change have driven extinction rates to **unprecedented levels**

Avoiding critical tipping points

- Reversing the loss or "**erosion**" of biosphere integrity is crucial to preventing catastrophic shifts in Earth's ecosystems
 - Addressing ecosystem damage and species loss is essential to avoiding reaching these critical tipping points
 - Ecosystem conservation efforts aim to preserve the structure, function and diversity of ecosystems
 - By protecting ecosystems, we can slow the rate of ecosystem damage and **reduce the risk of irreversible changes**
- Preserving species is a key factor in maintaining ecosystem integrity
 - Each species occupies a unique ecological niche within an ecosystem, contributing to its stability and resilience
 - Protecting ecosystems helps to preserve the niche requirements essential for the ongoing survival of individual species
- Various conservation strategies can help to protect ecosystems and preserve species diversity, including:
 - **Habitat conservation**: protecting natural habitats from destruction and fragmentation helps maintain ecosystem integrity

- **Species conservation:** using specific methods to protect the most endangered species is essential for biodiversity conservation
- **Sustainable resource management:** promoting sustainable practices ensures the responsible use of natural resources without degrading ecosystems



Examiner Tips and Tricks

When using real-world examples, like the Amazon rainforest, make sure you are able to explain how human activities, such as deforestation, can disrupt ecosystem stability and lead to new equilibria.

Remember that healthy, stable ecosystems and high species diversity are highly interdependent factors that sustain each other—a decrease in one will cause a decrease in the other and vice versa.



Your notes



Your notes

Classification (HL)

Clades

- The development of **DNA sequencing technology** means that classification can now be carried out on the basis of **evolutionary relationship**
- Organisms that are grouped together using this method of classification form groups known as **clades**
 - Every member of a clade shares a **common ancestor**
 - A common ancestor is a **shared** ancestor, e.g.
 - The most recent common ancestor of siblings is their parents
 - The most recent common ancestor of cousins is their grandparents
- Clades are **monophyletic** groups
 - This means they contain **all of the descendants of a common ancestor**

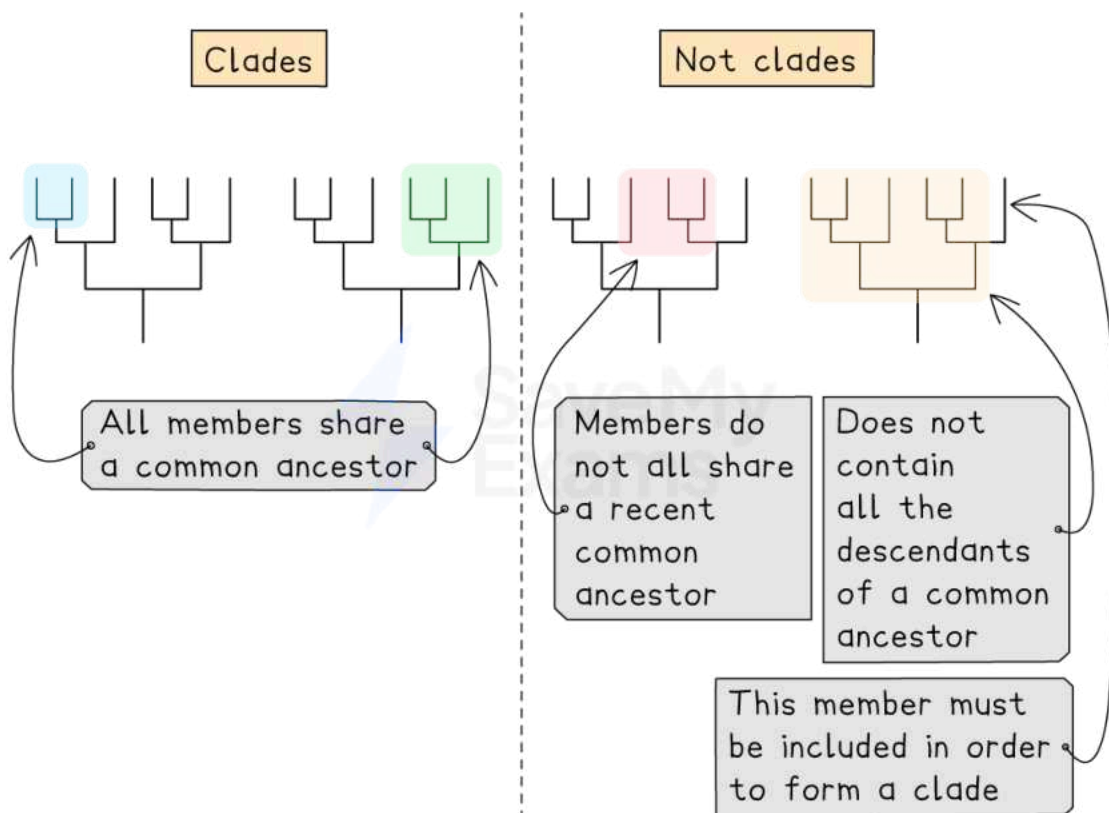

Copyright © Save My Exams. All Rights Reserved



Your notes

Example of groups that form clades and groups that do not form clades

- In the evolutionary tree below:
 - Chimpanzees and bonobos share a recent common ancestor
 - Chimpanzees are therefore most similar to bonobos (more similar than they are to any other primate species)
 - Chimpanzees and bonobos form a small clade
 - Humans share a more recent common ancestor with gorillas than they do with orangutans
 - This means we are closer to gorillas than we are to orangutans
 - Humans and gorillas **do not** form a clade
 - Humans, chimpanzees, bonobos, and gorillas **do** form a clade
 - All five primate species shown here share a common ancestor (from the distant past)
 - Humans, chimpanzees, bonobos, gorillas, and orangutans form the biggest clade

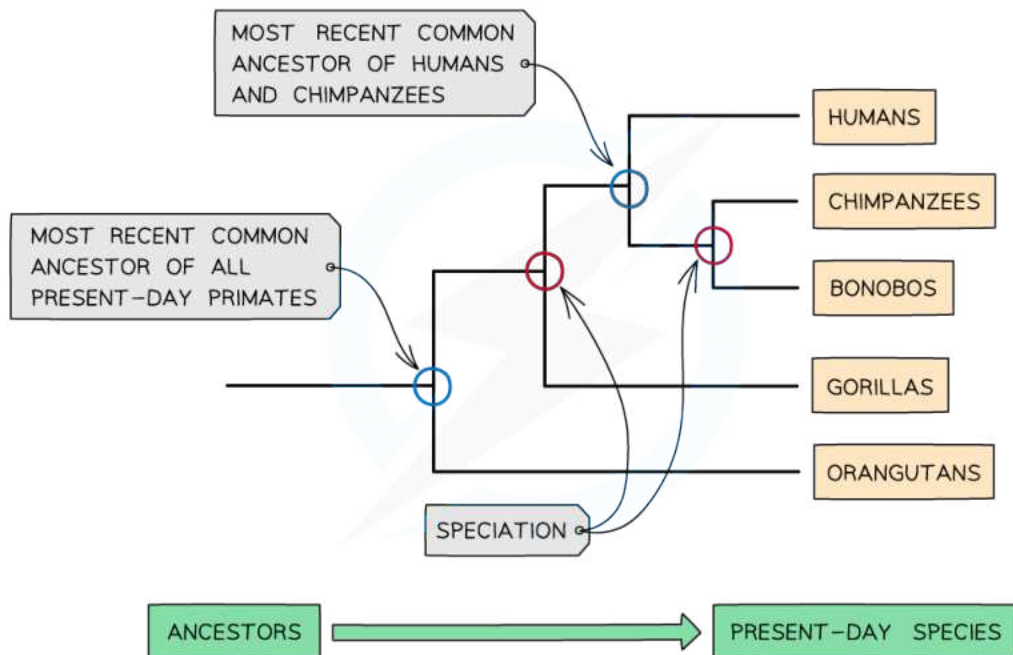

Copyright © Save My Exams. All Rights Reserved

An evolutionary tree for five species of primate



Your notes

Advantages of classification by evolutionary relationship

- Historically, organisms would have been classified on the basis of **morphology**
 - This often led to organisms being classified into groups that were not all close relatives
- Classifying organisms correctly **according to their clade** ensures that groups of organisms are **close evolutionary relatives** (rather than groups that happen to look similar)
 - The characteristics within a clade are often **inherited from a common ancestor**, so are likely to be shared
- The use of DNA sequencing has allowed some organisms to be **reclassified** into more accurate groups
 - Some species have been reclassified into **different groups** of organisms
 - Some groups of organisms have been **split**
 - Some groups have been **merged**

Cladistics

- Cladistics** is the branch of science in which scientists put organisms into **clades**
- Clades can include both **living** and **extinct** species
 - Some of the descendants of a common ancestor may have gone extinct
 - The common ancestor species itself may have gone extinct
- Clades can be **large** or **small** depending on the common ancestor being studied
- While **taxonomy** is about classifying and **naming organisms**, cladistics is about **identifying evolutionary relationships** between organisms
 - A **taxon** is a group of organisms that have been given a group name by taxonomists **on the basis on their shared features**
 - A **clade** is a group of organisms classified together **on the basis of their shared descent** from a common ancestor
- If taxonomy is carried out correctly, then **all of the members of a taxon should form a clade**

Cladograms

- Evolutionary relationships between species can be represented visually using a diagram called a **cladogram**
- Cladograms are **evolutionary trees** that show:
 - Order of divergence from ancestral species

- Relationships between species
- The point at which two branches separate is known as a **node**
 - Nodes represent **common ancestor** species
- Analysis of a cladogram can provide several important pieces of information:
 - A node **immediately adjacent** to a pair of clades indicates that these two clades share a **recent common ancestor**
 - This shows that the two clades are **more closely related to each other than they are to any other clade** in the cladogram
 - If **several nodes need to be traced back** before two clades can be joined, this indicates a **more distant relationship** between two clades
 - The **root** of a cladogram is found at its base
 - This represents the common ancestor of **all** of the organisms within the cladogram
 - The root of a cladogram will represent organisms that were present a long way back in **evolutionary history**
 - The **terminal branch** (i.e. the final branch) represents the **most recent** species in an evolutionary lineage
 - Some cladograms have a **time scale** to show how many millions have years have passed



Your notes



Your notes

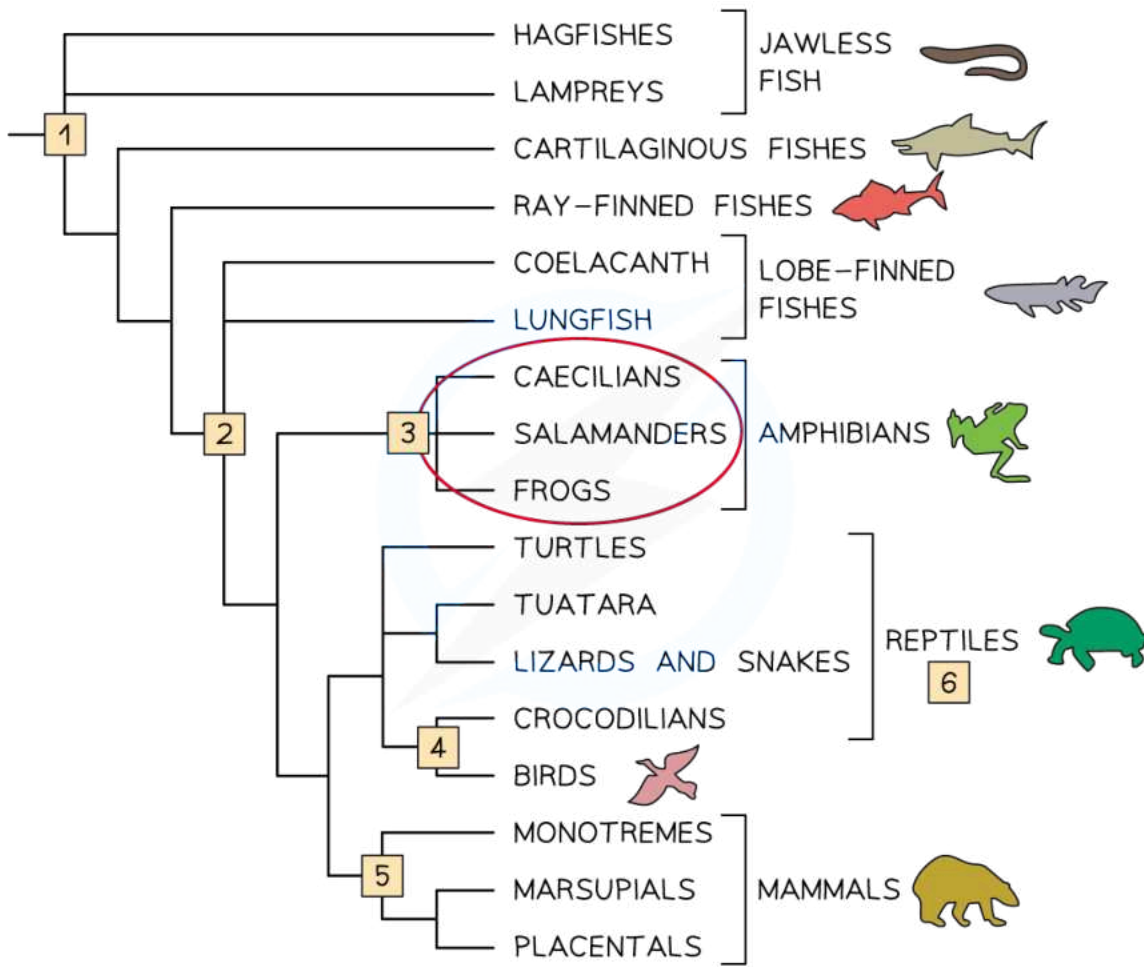

Copyright © Save My Exams. All Rights Reserved



Your notes

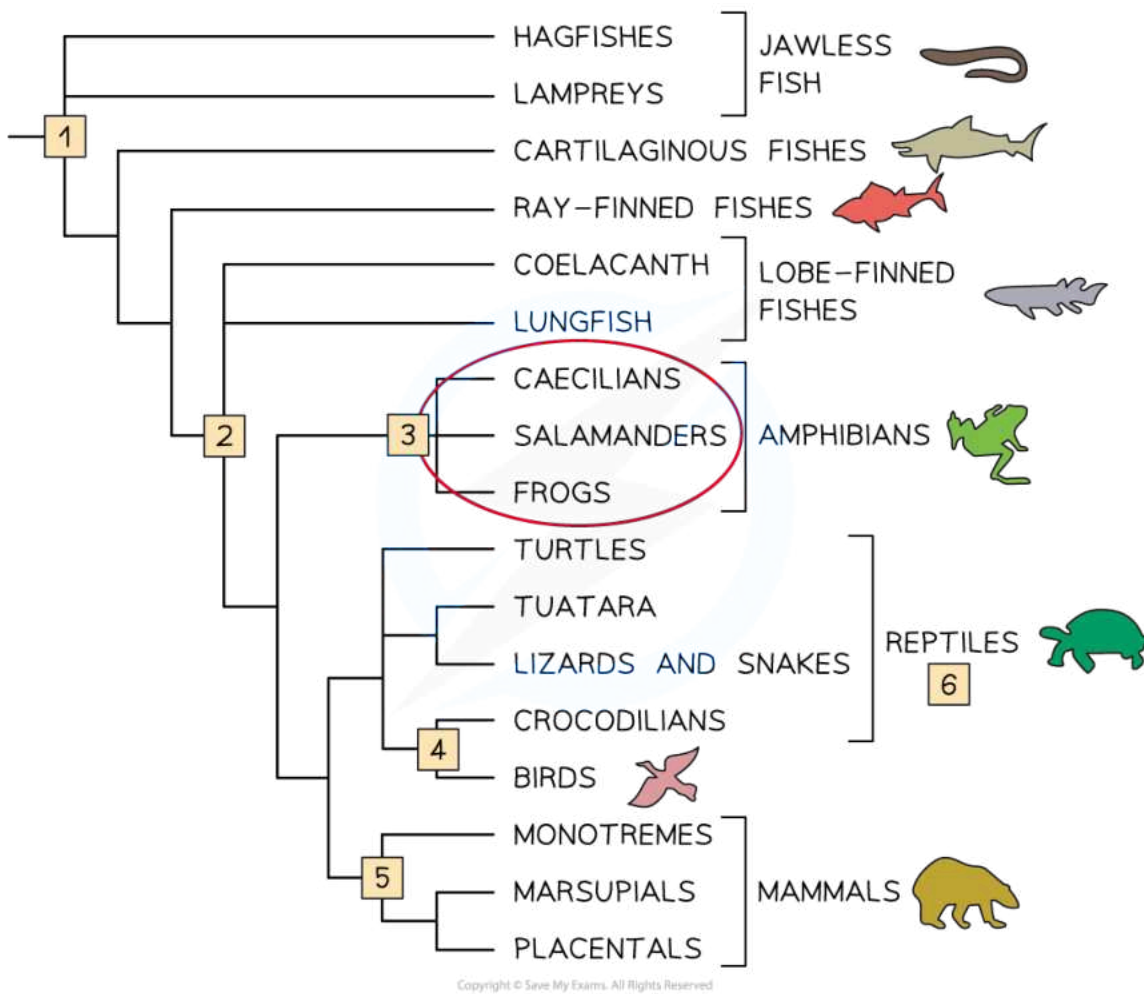

Difficulties in Classifying Organisms

The traditional hierarchy of taxa

- Biological classification involves putting organisms into groups, or **taxa** (singular **taxon**)
- The taxa form a **hierarchy**
 - A hierarchical system is one in which **larger groups contain smaller groups with no overlap** between groups
- The taxonomic hierarchy contains the following taxonomic groups in descending order of size:
 - Domain
 - Kingdom



Your notes

- Phylum
- Class
- Order
- Family
- Genus
- Species

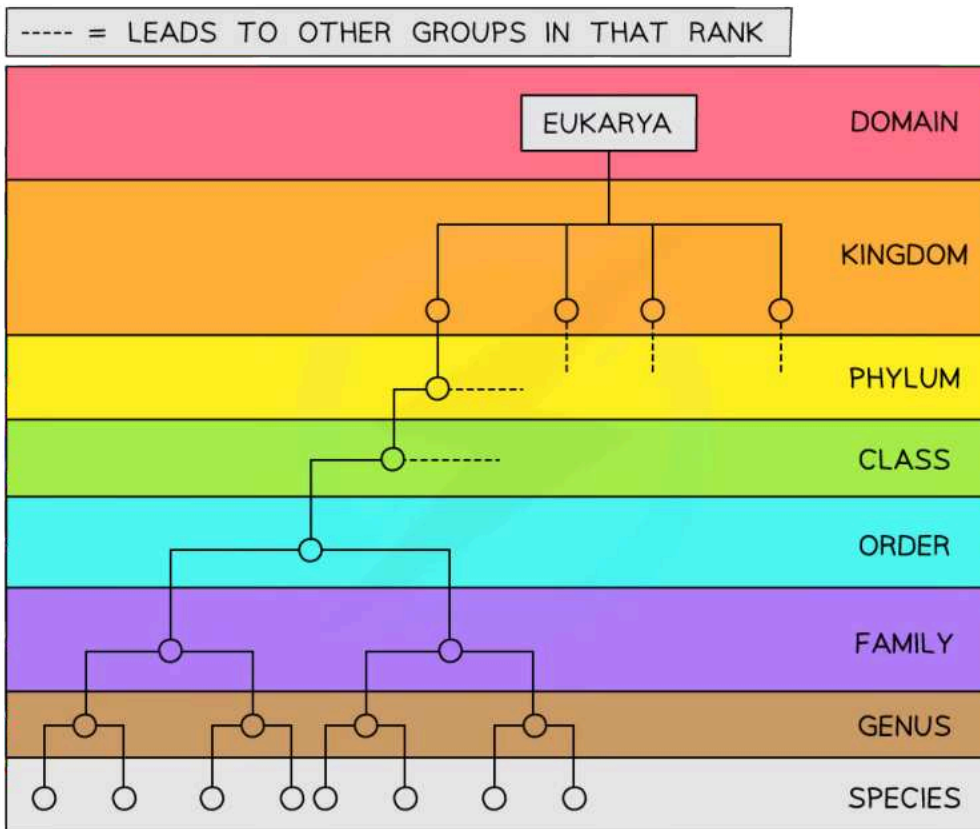

Copyright © Save My Exams. All Rights Reserved

The classification system within the Eukarya domain (note there are missing groups at each rank)

Difficulties with classification

- There are multiple challenges when it comes to accurately classifying organisms into the hierarchy of taxa described above
 - These difficulties include:

Morphology



Your notes

- Historically, organisms have been classified on the basis of their **morphology**, but this can lead to errors
- Similarities in observable characteristics do not always mean that organisms share a recent common ancestor
 - E.g. dolphins and sharks could in theory be grouped together as they are both groups of aquatic animals that share a similar body shape
 - However, they belong to **different classes**
 - Dolphins are **mammals** and sharks are **fish**
 - Their streamlined body shapes evolved separately rather than originating in one common ancestor
- One solution to this difficulty is to use **genome sequencing** data
 - This helps to avoid the difficulties with misleading morphology

Taxonomic rank

- In the hierarchy system described above, each level of classification fits into an established taxonomic rank
 - i.e. kingdom, phylum, class, etc.
- Classification can be complicated if:
 - A group of organisms falls **across taxa**
 - Or organisms need to be **moved from one taxon** to another
 - For example, plant species in **distant taxa** can sometimes breed together to produce **fertile hybrids**
 - The resulting offspring will technically be a new species, but will be very difficult to classify under the hierarchy of taxa
 - Moving a group of organisms between taxa can risk of needing to move all of the groups currently in a taxon into a different rank to make room for the new grouping

Species

- The point at which two populations are classified as different species can be **highly subjective**
- The fertile offspring of a cross between two species may go on to only breed with members of *one* parent species
 - This is known as **introgression**



Your notes

- Introgression demonstrates how difficult it can sometimes be to neatly apply species classification
 - The resulting offspring after several generations **do not fit completely into either species**
 - But **neither does it seem to make sense to classify them as a new species**
 - E.g. hundreds of thousands of years ago, an early human bred with a Neanderthal and the offspring of this cross then went on to breed only with early humans
 - The result of this is that some groups of modern humans have some Neanderthal genes in their genomes

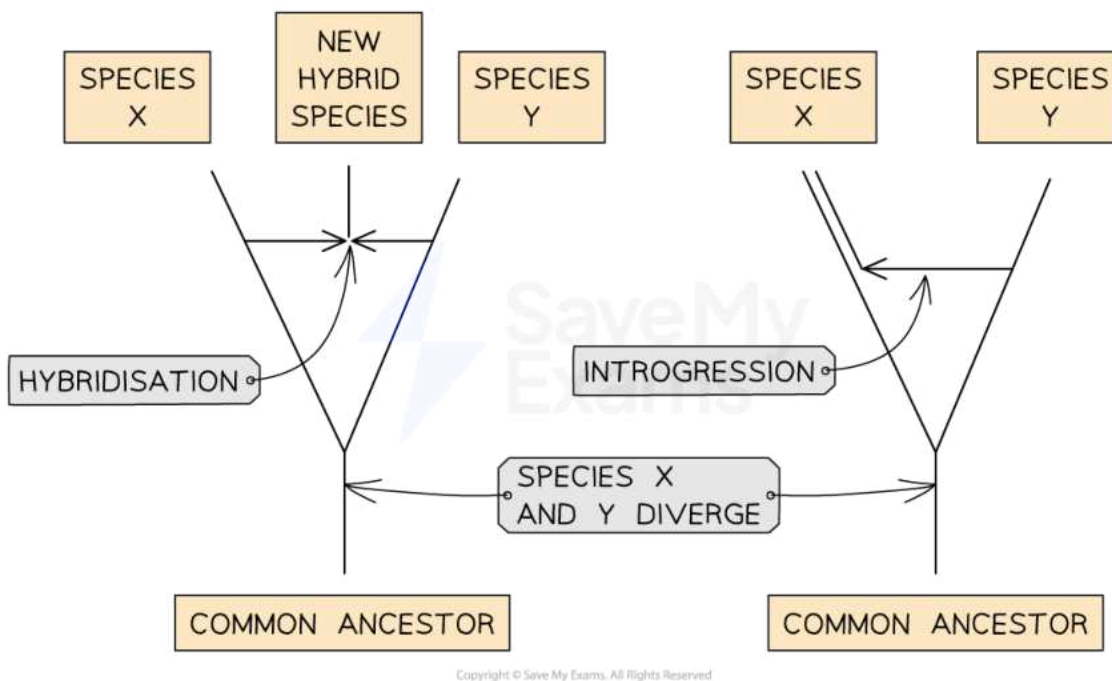

Several generations after an interbreeding event has occurred, the species X individuals with some genes from species Y do not fit perfectly into either species X or Y, but cannot correctly be considered a new species; this is introgression

- A fixed ranking of taxa may not be logical because it does not reflect the gradation of variation
 - The hierarchy of taxa described here has been **arbitrarily** set up by humans
 - This is mainly because it is a neat way of organising life into groups, not because it fits with the patterns that we see in the natural world
- In order to fall neatly into the taxonomic ranks of the traditional classification system, species need to:
 - Be **clearly distinct** from each other

- Obey **reproduction rules**, e.g. not interbreeding with other species
 - Produce fertile offspring
- This is far from the reality of the biological world, where the **differences between organisms are on a gradual scale** and **neat breeding rules do not always apply**
- A successful classification system needs to **follow the evidence** rather than seeking to fit the natural world into a human-designed system
 - New evidence comes from **genome sequencing**, and often leads to the reclassification of species
 - The newer system of **cladistics** uses **unranked groups** based on **evolutionary relationships** alone to produce evolutionary trees



Your notes



Your notes

Fundamental & Realised Niches (HL)

Fundamental & Realised Niches

- The fundamental niche describes:

The full range of conditions and resources in which a species could survive and reproduce if there were no limiting factors

- The realised niche describes:

The actual conditions and resources in which a species exists due to biotic interactions

or

The actual mode of existence of a species, which results from its adaptations and competition with other species

An example of a fundamental niche compared to a realised niche can be seen in the case of the **barnacle** species *Chthamalus dalli*

- Its fundamental niche includes a wide range of rocky intertidal areas in the Pacific Northwest
 - Here, it can attach to a variety of **substrates** and tolerate a wide range of temperature and salinity conditions



Your notes

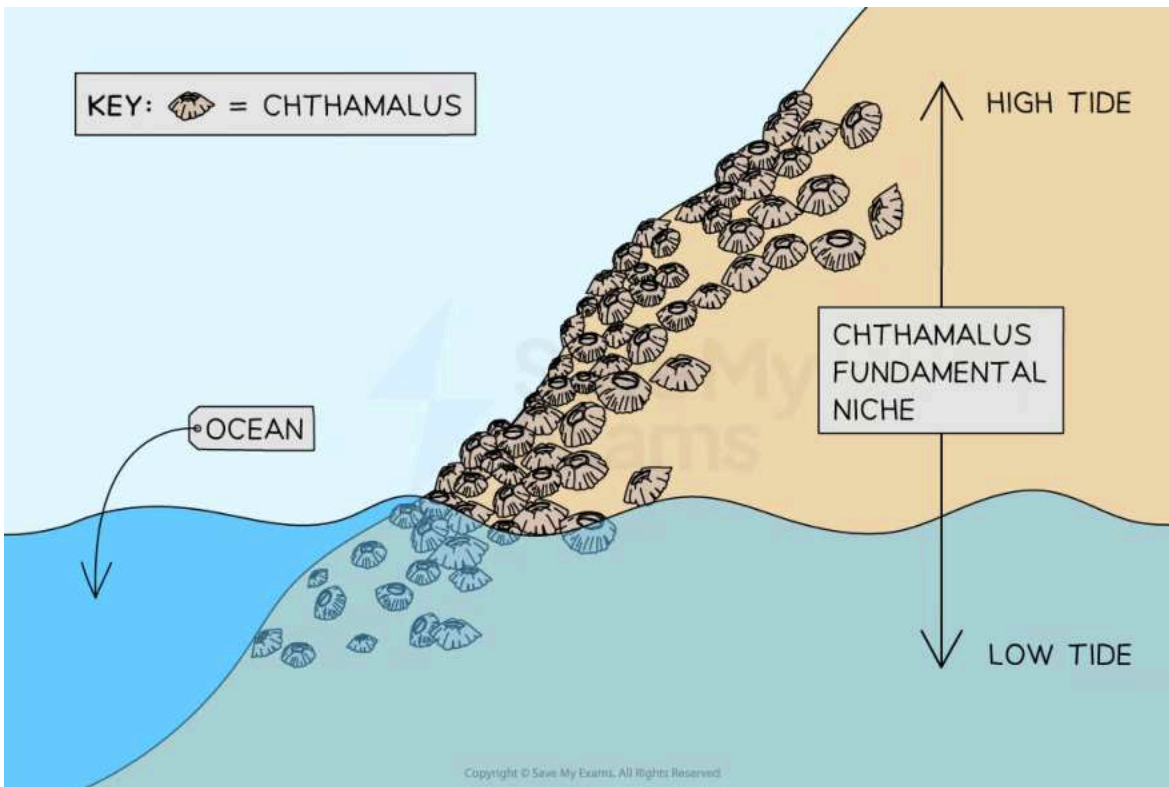

***Chthamalus* fundamental niche**

- However, in reality, the realised niche of this species is much smaller or 'narrower' due to **competition** with other barnacle species, such as *Balanus glandula*, for space and resources
 - As a result, the actual range of *Chthamalus dalli* is **restricted** to areas where *Balanus glandula* is absent or scarce, such as higher up on the shore
 - Here, it is exposed to air for longer periods of time and can avoid competition with *Balanus glandula* for **space** and **resources**



Your notes

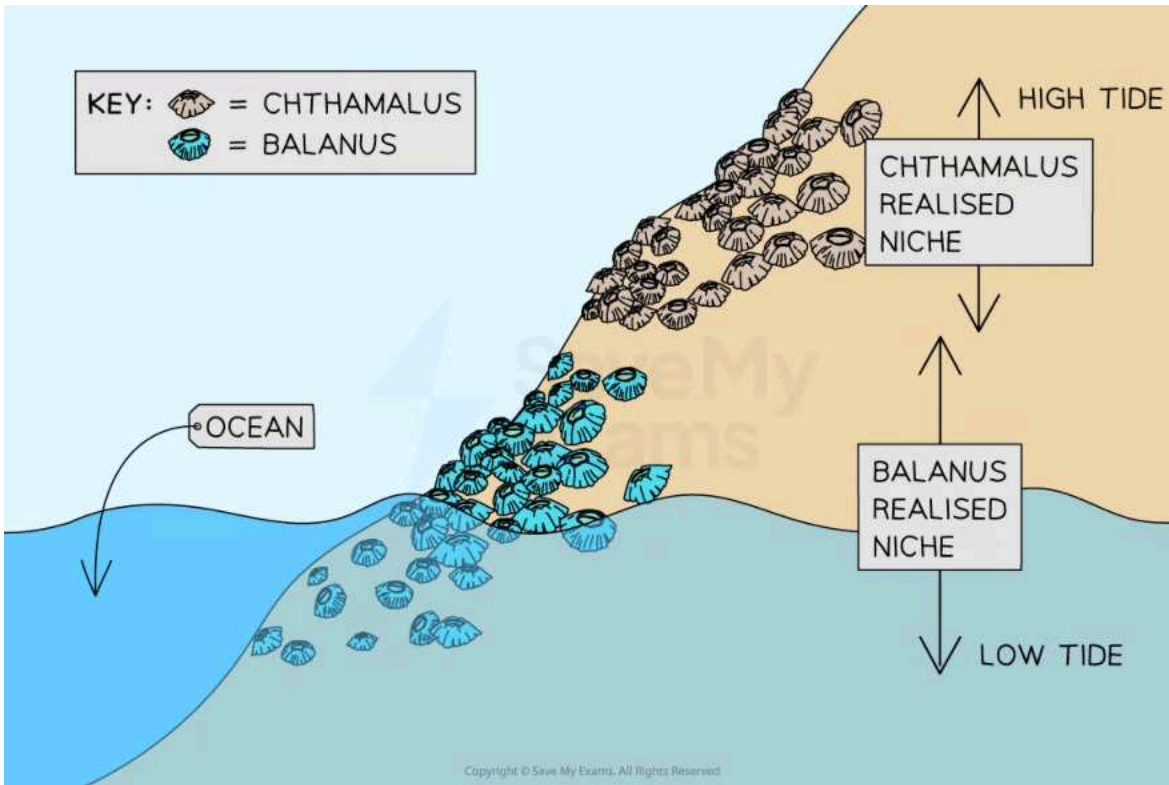

Chthamalus realised niche

- Therefore, the realised niche of *Chthamalus dallia* is **smaller** than its fundamental niche due to the **biotic interactions** with other species



Examiner Tips and Tricks

Remember that the realised niche results from both adaptations to the environment and the pressures of competition with other species.

In exams, you might be asked to apply this concept to species not mentioned in the syllabus. Practice using the fundamental vs. realised niche framework on different species from other ecosystems.

Life Cycles (HL)



Your notes

Life Cycles of Different Species

- Every species has a life cycle that includes stages of growth, reproduction, and death
- Life cycles can vary greatly between species in terms of:
 - Reproductive behaviour
 - Lifespan
- Some species reproduce quickly with many offspring, while others invest heavily in fewer offspring to ensure their survival

r-strategists

- **r-strategists** are species that produce **many offspring** but provide **little or no parental care**
- These species tend to live in **unstable** or **unpredictable environments**
 - In these environments, the ability to reproduce quickly is an advantage
- For example, insects like flies or mosquitoes are r-strategists
 - They lay hundreds of eggs at once but do not care for them
- r-strategists are good at **colonising new habitats** or taking advantage of temporary resources
- They typically have short lifespans and their population size can fluctuate rapidly
- **Rabbits** are another example of an r-strategist
 - They reproduce quickly and in large numbers, making them well-suited to environments where food availability fluctuates



Your notes



Flies are r-strategists (Photo by MOHD AZRIEN AWANG BESAR on Unsplash)

K-strategists

- **K-strategists** produce **fewer offspring** but invest more in their **care** to **increase the survival rate**
- These species tend to live in **stable environments**
 - In these environments, competition for resources is high
- For example, elephants are K-strategists
 - They produce one calf at a time and invest heavily in its care for years
- K-strategists generally have longer lifespans, stable populations, and thrive in mature ecosystems
- **Oak trees** are another example of K-strategists
 - They produce fewer seeds (acorns), but these seeds have a better chance of growing into mature trees due to the stable environment of a mature forest



Large mammals such as rhinos are K-strategists (Photo by Glen Carrie on Unsplash)

Comparing r- and K-strategists

- **r-strategists:**
 - Many offspring
 - Little or no parental care
 - Short lifespan
 - Population size fluctuates
 - Adapted to unstable environments
 - Examples: bacteria, dandelions, some small mammals

- **K-strategists:**
 - Few offspring
 - High parental care
 - Long lifespan
 - Stable population size



Your notes

- Adapted to stable environments
- Examples: humans, large mammals like whales and elephants

Succession and life cycles

- In early stages of succession, **r-strategists tend to dominate** because they can colonise quickly.
- As the environment stabilises and matures, K-strategists become more dominant due to their competitive advantage in resource-rich but stable environments

Human Impacts on Life Cycles

- Human activities, such as pollution, habitat destruction, and climate change, can have significant impacts on the life cycles of plants and animals
- Understanding a species' **niche** and its **life cycle** is important for identifying how humans affect these processes

Climate change and life cycles

- **Climate change** alters environmental conditions like **temperature** and **rainfall patterns**
 - This can affect species' life cycles
 - For example, warmer temperatures caused by climate change can lead to:
 - **Earlier flowering** in plants
 - **Changes in migration** patterns of birds
- Many species' life cycles are **synchronised** with the **seasons**
 - For example, plants might flower in spring when pollinators like bees are most active
- If climate change causes this timing to shift, it can disrupt the relationship between species
 - For example, the pied flycatcher bird migrates to Europe in the spring to feed on caterpillars
 - If caterpillars emerge earlier due to warmer springs, the birds may arrive too late to find food, affecting their reproduction
 - Insects like butterflies rely on specific temperature ranges for development
 - Warmer temperatures can cause butterflies to emerge earlier in the season
 - This may lead to mismatches with the flowering of the plants they rely on for nectar
- The melting of Arctic sea ice due to global warming impacts the life cycles of polar bears
 - Polar bears rely on sea ice to hunt seals



Your notes

- With less ice, their hunting season shortens, reducing their fat reserves needed for reproduction and survival

Habitat destruction and life cycles

- **Deforestation** and **urban expansion** can disrupt the habitats that species rely on for parts of their life cycles, like breeding or feeding grounds
 - For example, sea turtles return to specific beaches to lay their eggs
 - However, these habitats are threatened by tourism and development, affecting their reproductive success
 - Destruction of **wetlands** impacts amphibians like frogs, which depend on these areas for breeding

Pollution and life cycles

- **Pollution** can directly affect the life cycles of species by damaging their health or the habitats they depend on
 - For example, **pesticides** used in agriculture can reduce insect populations
 - This impacts the life cycles of species that feed on them, like birds or bats
 - The use of neonicotinoid pesticides in agriculture affects the life cycles of bees
 - Exposure to these chemicals reduces their ability to forage and reproduce
 - This threatens populations of these pollinators that are crucial for many plant species, including crops for human consumption



Your notes