

# DP IB Maths: AA HL



Your notes

## 3.3 Trigonometry Toolkit

### Contents

- \* 3.3.1 Pythagoras & Right-Angled Trigonometry
- \* 3.3.2 Non Right-Angled Trigonometry
- \* 3.3.3 Applications of Trigonometry & Pythagoras



Your notes

## 3.3.1 Pythagoras & Right-Angled Trigonometry

### Pythagoras

#### What is the Pythagorean theorem?

- Pythagoras' theorem is a formula that works for **right-angled triangles** only
- It states that for any right-angled triangle, the **square of the hypotenuse is equal to the sum of the squares of the two shorter sides**
  - The **hypotenuse** is the **longest side** in a right-angled triangle
    - It will always be **opposite** the right angle
  - If we label the hypotenuse  $c$ , and label the other two sides  $a$  and  $b$ , then Pythagoras' theorem tells us that

$$a^2 + b^2 = c^2$$

- The formula for Pythagoras' theorem is assumed prior knowledge and is **not in the formula booklet**
  - You will need to remember it

#### How can we use Pythagoras' theorem?

- If you know two sides of any right-angled triangle you can use Pythagoras' theorem to find the length of the third side
  - Substitute the values you have into the formula and either solve or rearrange
- To find the length of the **hypotenuse** you can use:

$$c = \sqrt{a^2 + b^2}$$

- To find the length of **one of the other sides** you can use:

$$a = \sqrt{c^2 - b^2} \text{ or } b = \sqrt{c^2 - a^2}$$

- Note that when finding the **hypotenuse** you should **add** inside the square root and when finding **one of the other sides** you should **subtract** inside the square root
- Always **check** your answer carefully to make sure that the hypotenuse is the longest side
- Note that Pythagoras' theorem questions will rarely be standalone questions and will often be 'hidden' in other geometry questions

#### What is the converse of the Pythagorean theorem?

- The converse of the Pythagorean theorem states that if  $a^2 + b^2 = c^2$  is true then the triangle must be a right-angled triangle
  - This is a very useful way of determining whether a triangle is right-angled
- If a diagram in a question does not clearly show that something is right-angled, you may need to use Pythagoras' theorem to check

### Examiner Tip

- Pythagoras' theorem pops up in lots of exam questions so bear it in mind whenever you see a right-angled triangle in an exam question!



Your notes



Your notes

 **Worked example**

ABCDEF is a chocolate bar in the shape of a triangular prism. The end of the chocolate bar is an isosceles triangle where  $AC = 3\text{ cm}$  and  $AB = BC = 5\text{ cm}$ . M is the midpoint of AC. This information is shown in the diagram below.

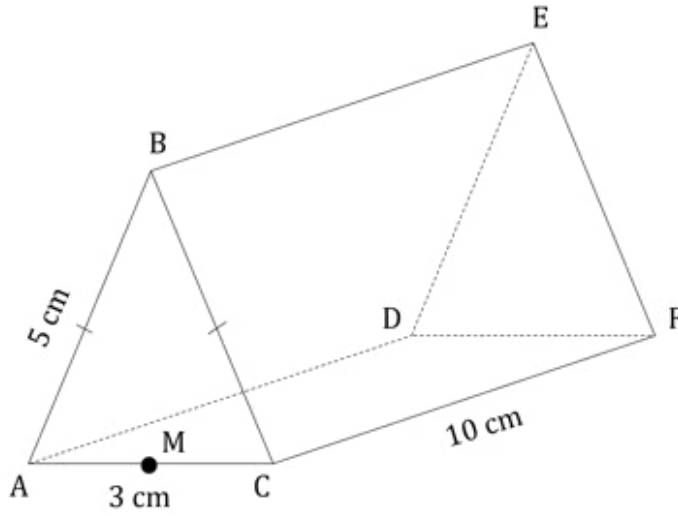

Calculate the length BM.



Your notes

Sketch the triangle ABM:

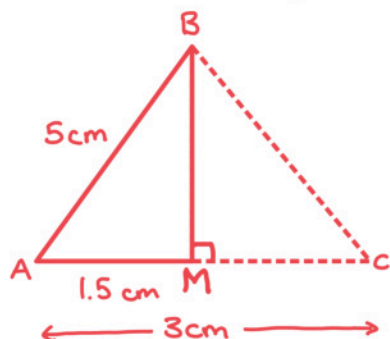

By the Pythagorean Theorem:

$$\begin{aligned}
 \underset{\substack{\uparrow \\ \text{shorter} \\ \text{side}}}{BM^2} &= \sqrt{\underset{\substack{\uparrow \\ \text{hypotenuse}}}{AB^2} - \underset{\substack{\uparrow \\ \text{shorter side}}}{AM^2}} \\
 &= \sqrt{5^2 - 1.5^2} \\
 &= \sqrt{22.75}
 \end{aligned}$$

$$BM = 4.77 \text{ cm (3sf)}$$



Your notes

## Right-Angled Trigonometry

### What is Trigonometry?

- Trigonometry is the mathematics of angles in triangles
- It looks at the relationship between side lengths and angles of triangles
- It comes from the Greek words *trigonon* meaning 'triangle' and *metron* meaning 'measure'

### What are Sin, Cos and Tan?

- The three trigonometric functions Sine, Cosine and Tangent come from ratios of side lengths in right-angled triangles
- To see how the ratios work you must first label the sides of a right-angled triangle in relation to a chosen angle
  - The **hypotenuse, H**, is the **longest side** in a right-angled triangle
    - It will always be **opposite** the right angle
    - If we label one of the other angles  $\theta$ , the side opposite  $\theta$  will be labelled **opposite, O**, and the side next to  $\theta$  will be labelled **adjacent, A**
- The functions Sine, Cosine and Tangent are the ratios of the lengths of these sides as follows

$$\sin \theta = \frac{\text{opposite}}{\text{hypotenuse}} = \frac{O}{H}$$

$$\cos \theta = \frac{\text{adjacent}}{\text{hypotenuse}} = \frac{A}{H}$$

$$\tan \theta = \frac{\text{opposite}}{\text{adjacent}} = \frac{O}{A}$$

- These are **not in the formula book**, you must remember them
- The mnemonic **SOHCAHTOA** is often used as a way of remembering which ratio is which
  - **S**in is **O**pposite over **H**ypotenuse
  - **C**os is **A**djacent over **H**ypotenuse
  - **T**an is **O**pposite over **A**djacent



Your notes

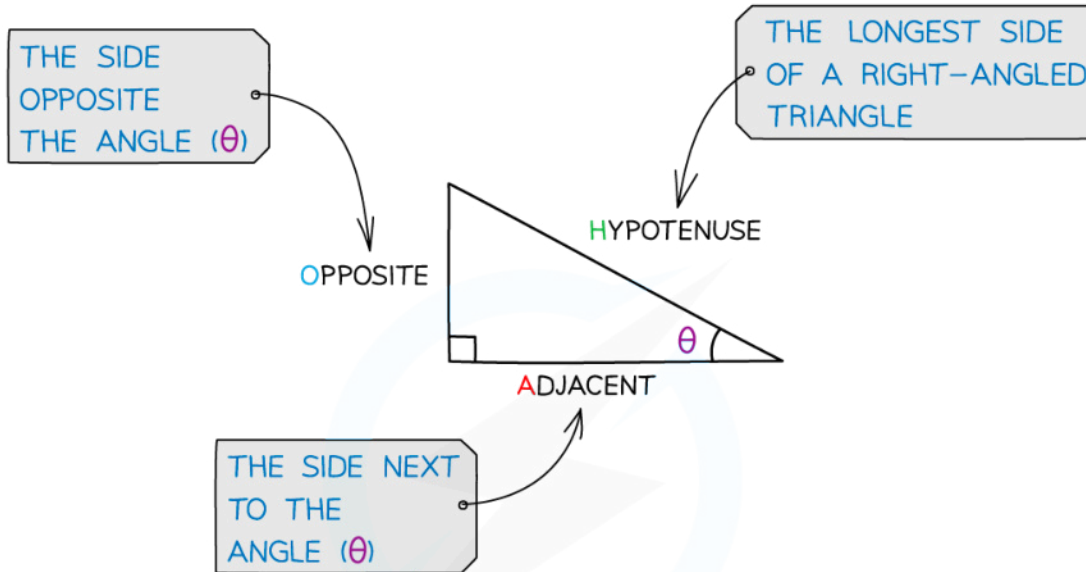

$$\sin \theta = \frac{\text{OPPOSITE}}{\text{HYPOTENUSE}}$$

$$S = \frac{O}{H}$$

$$\cos \theta = \frac{\text{ADJACENT}}{\text{HYPOTENUSE}}$$

$$C = \frac{A}{H}$$

$$\tan \theta = \frac{\text{OPPOSITE}}{\text{ADJACENT}}$$

$$T = \frac{O}{A}$$

Copyright © Save My Exams. All Rights Reserved

### How can we use SOHCAHTOA to find missing lengths?

- If you know the length of one of the sides of any right-angled triangle and one of the angles you can use SOHCAHTOA to find the length of the other sides
  - Always start by **labelling the sides** of the triangle with H, O and A
  - Choose the correct ratio by looking only at the values that you have and that you want
    - For example if you know the angle and the side opposite it (O) and you want to find the hypotenuse (H) you should use the sine ratio
  - Substitute the values into the ratio
  - Use your calculator to find the solution

### How can we use SOHCAHTOA to find missing angles?

- If you know two sides of any right-angled triangle you can use SOHCAHTOA to find the size of one of the angles
- Missing angles are found using the **inverse functions**:

$$\theta = \sin^{-1} \frac{O}{H}, \theta = \cos^{-1} \frac{A}{H}, \theta = \tan^{-1} \frac{O}{A}$$

- After choosing the correct ratio and substituting the values use the inverse trigonometric functions on your calculator to find the correct answer

### Examiner Tip

- You need to remember the sides involved in the different trig ratios as they are not given to you in the exam



Your notes





Your notes

 **Worked example**

Find the values of  $x$  and  $y$  in the following diagram. Give your answers to 3 significant figures.

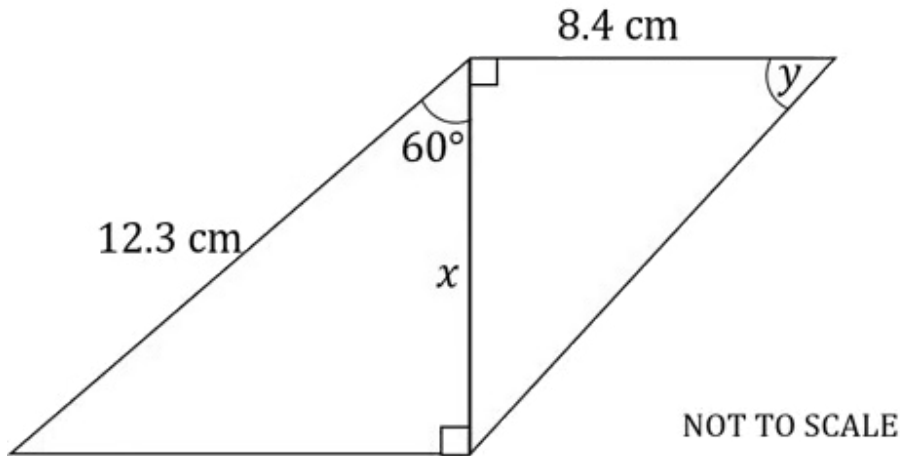



Your notes

Start by labelling the sides of the triangle:

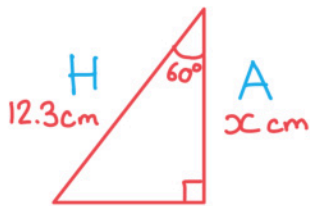

SOHCAHTOA

We know H and we want to find A so we need to use

$$\cos \theta = \frac{A}{H}$$

$$\cos 60^\circ = \frac{x}{12.3}$$

$$x = 12.3 \cos 60^\circ$$

$$x = 6.15 \text{ cm}$$

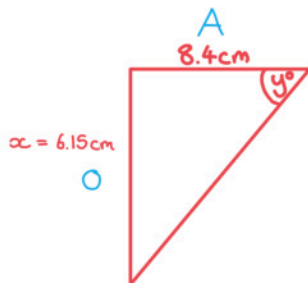

SOHCAHTOA

$$\tan y^\circ = \frac{O}{A}$$

$$\tan y^\circ = \frac{6.15}{8.4}$$

$$y^\circ = \tan^{-1} \left( \frac{6.15}{8.4} \right)$$

$$y^\circ = 36.2^\circ \text{ (3 s.f.)}$$

## 3D Problems

### How does Pythagoras work in 3D?

- 3D shapes can often be broken down into several 2D shapes
- With Pythagoras' Theorem you will be specifically looking for right-angled triangles
  - The right-angled triangles you need will have two known sides and one unknown side
  - Look for perpendicular lines to help you spot right-angled triangles
- There is a 3D version of the Pythagorean theorem formula:

$$d^2 = x^2 + y^2 + z^2$$

- However it is usually easier to see a problem by breaking it down into two or more 2D problems

### How does SOHCAHTOA work in 3D?

- Again look for a combination of right-angled triangles that would lead to the missing angle or side
- The angle you are working with can be awkward in 3D
  - The angle between a line and a plane is not always obvious
  - If unsure put a point on the line and draw a new line to the plane
    - This should create a right-angled triangle



Your notes



Your notes

ANGLE BETWEEN A LINE AND A PLANE

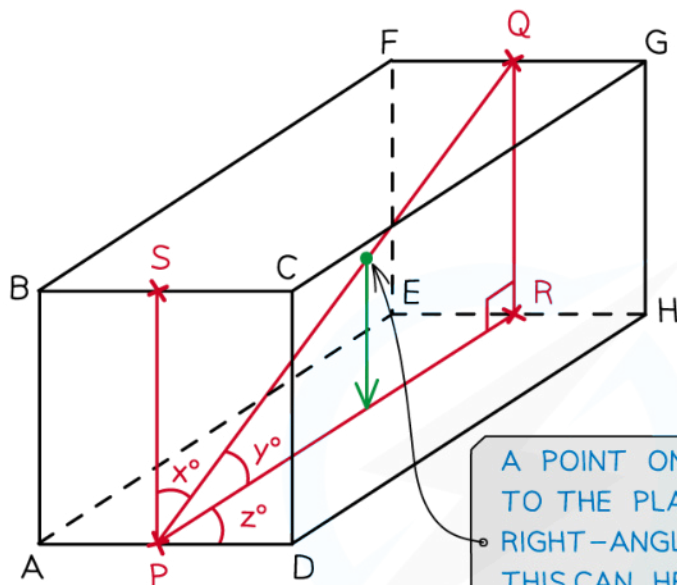

A POINT ON THE LINE CONNECTED TO THE PLANE CREATES A RIGHT-ANGLED TRIANGLE AND THIS CAN HELP IDENTIFY THE ANGLE REQUIRED\*

$x^\circ$  IS THE ANGLE BETWEEN THE LINE PQ AND THE PLANE ABCD (LINE PS)

$y^\circ$  IS THE ANGLE BETWEEN THE LINE PQ AND THE PLANE AEHD (LINE PR)

$z^\circ$  IS THE ANGLE BETWEEN THE LINE PR AND THE LINE AD

Copyright © Save My Exams. All Rights Reserved

 **Examiner Tip**

- Annotate diagrams that are given to you with values that you have calculated
- It can be useful to make additional sketches of parts of any diagrams that are given to you, especially if there are multiple lengths/angles that you are asked to find
- If you are not given a diagram, sketch a nice, big, clear one!



Your notes

 **Worked example**

A pencil is being put into a cuboid shaped box. The base of the box has a width of 4 cm and a length of 6 cm. The height of the box is 3 cm. Find:

- a) the length of the longest pencil that could fit inside the box,

Draw a diagram:

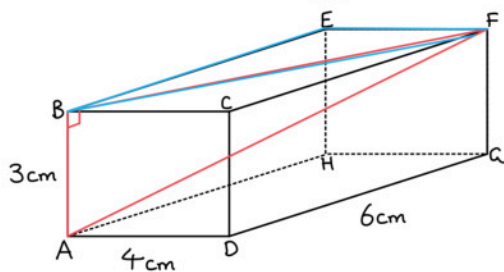

The longest pencil could fit on any of the diagonals, e.g. AF.

To find AF we must first find BF:

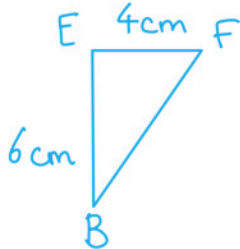

$$BF^2 = 4^2 + 6^2$$

$$BF^2 = 16 + 36$$

$$BF^2 = 52$$

← Can leave as  $BF^2$  for now.

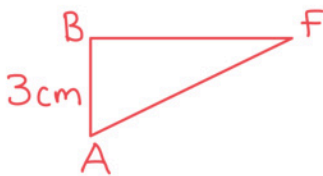

$$AF^2 = 3^2 + BF^2$$

$$= 9 + 52$$

$$AF^2 = 61$$

$$AF = \sqrt{61} = 7.8102\dots$$

**7.81 cm (3 s.f.)**

- b) the angle that the pencil would make with the top of the box.



Your notes

Find  $\hat{A}FB$ :

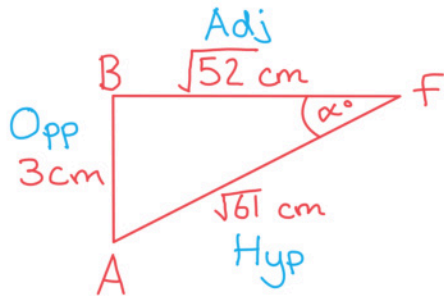

All three sides are known so can use any of the trig ratios.

SOH CAHTOA

↑  
Choose  $\tan \alpha = \frac{\text{OPP}}{\text{adj}}$

$$\tan \alpha = \frac{3}{\sqrt{52}}$$

$$\alpha = \tan^{-1}\left(\frac{3}{\sqrt{52}}\right)$$

$$= 22.588\dots$$

$$\hat{A}FB = 22.6^\circ \text{ (3 s.f.)}$$



Your notes

## 3.3.2 Non Right-Angled Trigonometry

### Sine Rule

#### What is the sine rule?

- The sine rule allows us to find missing side lengths or angles in **non-right-angled triangles**
- It states that for any triangle with angles  $A$ ,  $B$  and  $C$

$$\frac{a}{\sin A} = \frac{b}{\sin B} = \frac{c}{\sin C}$$

- Where
  - $a$  is the side **opposite** angle  $A$
  - $b$  is the side **opposite** angle  $B$
  - $c$  is the side **opposite** angle  $C$
- This formula **is in the formula booklet**, you do not need to remember it
- $\sin 90^\circ = 1$  so if one of the angles is  $90^\circ$  this becomes SOH from **SOHCAHTOA**

LABEL YOUR TRIANGLE WITH CAPITALS FOR ANGLES AND LOWER CASE FOR THE OPPOSITE SIDE

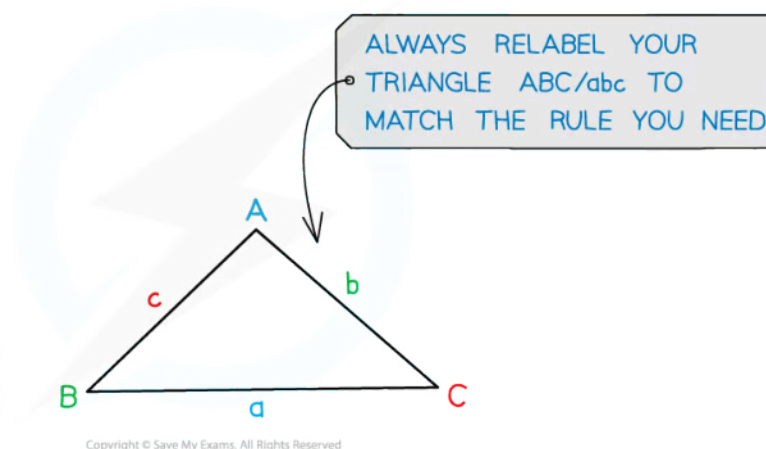

#### How can we use the sine rule to find missing side lengths or angles?

- The sine rule can be used when you have any opposite pairs of sides and angles
- Always **start by labelling your triangle** with the angles and sides
  - Remember the sides with the lower-case letters are **opposite** the angles with the equivalent upper-case letters
- Use the formula in the formula booklet to find the **length of a side**
- To find a missing angle you can rearrange the formula and use the form

$$\frac{\sin A}{a} = \frac{\sin B}{b} = \frac{\sin C}{c}$$

- This is **not in the formula booklet** but can easily be found by rearranging the one given
- Substitute the values you have into the formula and solve

### Examiner Tip

- If you're using a calculator make sure that it is in the correct mode (degrees/radians)
- Remember to give your answers as exact values if you are asked too



Your notes





Your notes

 **Worked example**

The following diagram shows triangle ABC.  $AB = 8.1 \text{ cm}$ ,  $BC = 12.3 \text{ cm}$ ,  $\widehat{BCA} = 27^\circ$ .

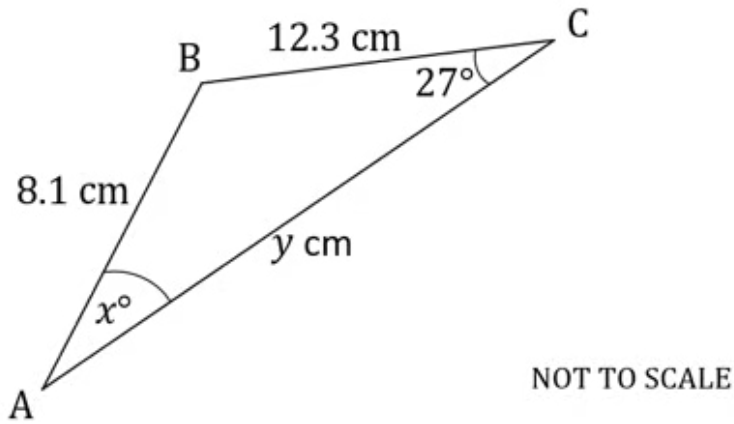

Use the sine rule to calculate the value of:

- i)  $x$ ,



Your notes

Sketch the diagram and label the sides:

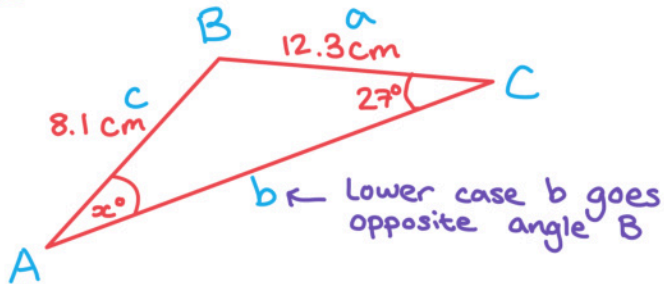

Using the sine rule:

$$\frac{\sin A}{a} = \frac{\sin B}{b} = \frac{\sin C}{c}$$

We are looking for an angle so this version is easier.

$$\frac{\sin \alpha}{12.3} = \frac{\sin 27}{8.1}$$

$$\sin \alpha = \frac{12.3 \sin 27}{8.1}$$

$$\alpha = \sin^{-1}\left(\frac{12.3 \sin 27}{8.1}\right)$$

$$\alpha = 43.6^\circ \text{ (3s.f.)}$$

ii) y.



Your notes

Sketch the diagram and label the sides:

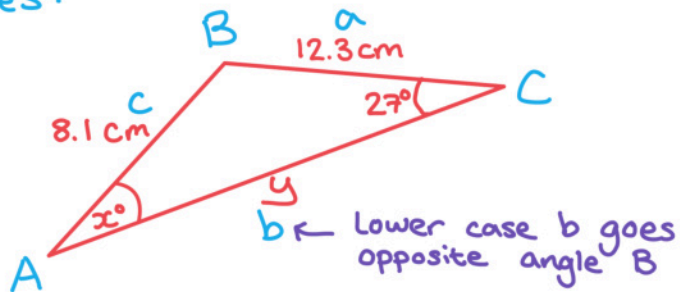

Find  $\hat{A}BC$ :  $180 - (27 + 43.582\dots)$

$\hat{A}BC = 109.417\dots$

Using the sine rule:

$$\frac{a}{\sin A} = \frac{b}{\sin B} = \frac{c}{\sin C}$$

← We are looking for a side so this version is easier.

$$\frac{y}{\sin(109.417\dots)} = \frac{8.1}{\sin 27}$$

$$y = \frac{8.1 \sin(109.417\dots)}{\sin 27}$$

$y = 16.8 \text{ cm (3 s.f.)}$

## Ambiguous Sine Rule

### What is the ambiguous case of the sine rule?

- If the sine rule is used in a triangle **given two sides and an angle which is not the angle between them** there **may** be more than one possible triangle which could be drawn
- The side **opposite** the given angle could be in two possible positions
- This will create two possible values for each of the missing angles and two possible lengths for the missing side
- The two angles found **opposite** the given side (not the ambiguous side) will **add up to  $180^\circ$** 
  - In IB the question will usually tell you whether the angle you are looking for is **acute** or **obtuse**
  - The sine rule will always give you the acute option but you can **subtract from  $180^\circ$**  to find the obtuse angle
  - Sometimes the obtuse angle will not be valid
    - It could cause the sum of the three interior angles of the triangle to exceed  $180^\circ$



Your notes



Your notes

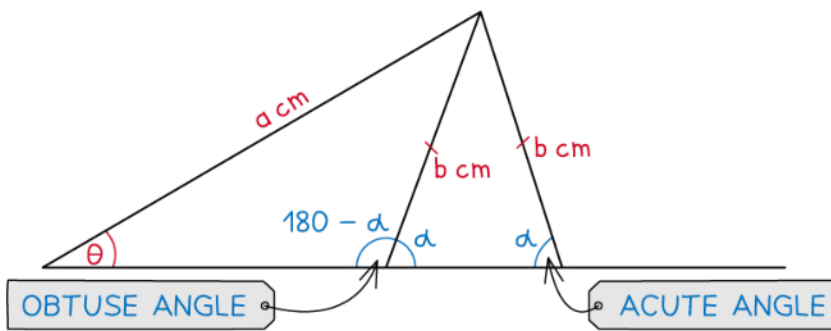
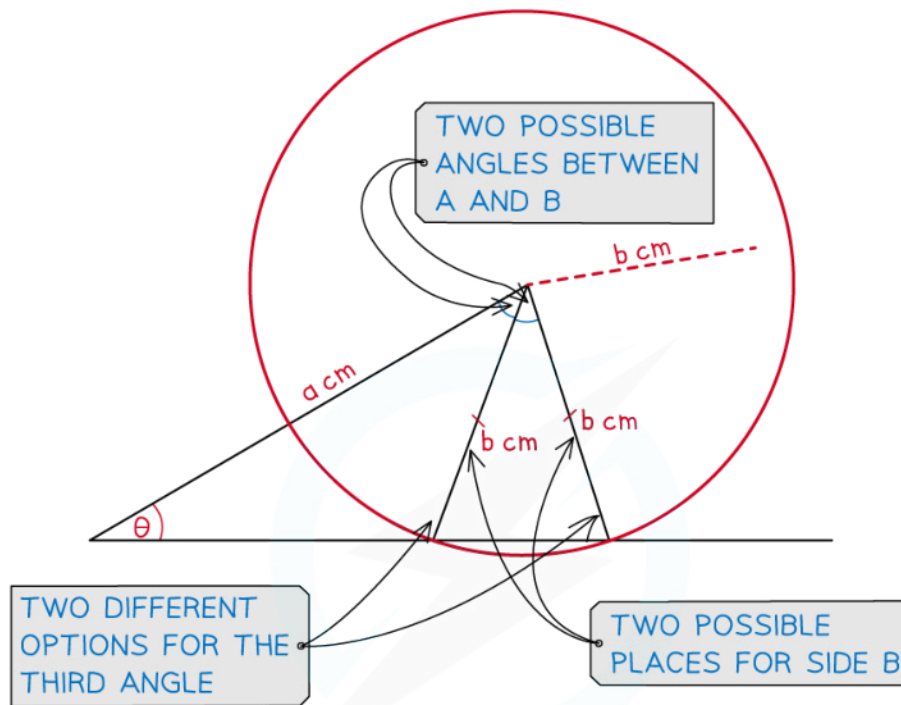

Copyright © Save My Exams. All Rights Reserved

 **Examiner Tip**

- Make sure that you are clear which of the two answers is the one that is required and make sure that you communicate this clearly to the examiner by writing it on the answer line!



Your notes

**Worked example**

Given triangle  $ABC$ ,  $AB = 8 \text{ cm}$ ,  $BC = 5 \text{ cm}$ ,  $\widehat{BAC} = 35^\circ$ . Find the two possible options for  $\widehat{ACB}$ , giving both answers to 1 decimal place.

There are two ways triangle  $ABC$  can be drawn:

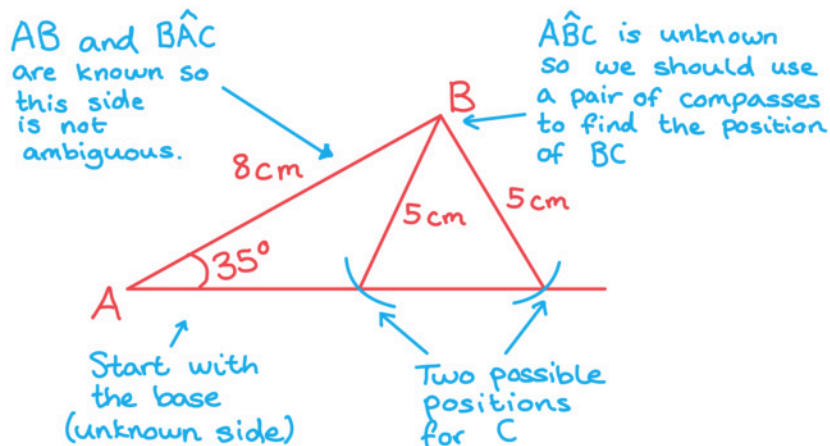

$$\begin{aligned} \text{Find } \widehat{ACB}: \quad \frac{\sin 35^\circ}{5} &= \frac{\sin C}{8} \\ C &= \sin^{-1}\left(\frac{8 \sin 35^\circ}{5}\right) \\ &= 66.59\dots \end{aligned}$$

$$\widehat{ACB} = 66.6^\circ \text{ or } 113.4^\circ \text{ (1dp)}$$



Your notes

## Cosine Rule

### What is the cosine rule?

- The cosine rule allows us to find missing side lengths or angles in **non-right-angled triangles**
- It states that for any triangle

$$c^2 = a^2 + b^2 - 2ab\cos C ; \cos C = \frac{a^2 + b^2 - c^2}{2ab}$$

- Where
  - $c$  is the side **opposite** angle  $C$
  - $a$  and  $b$  are the other two sides
- Both of these formulae **are in the formula booklet**, you do not need to remember them
  - The first version is used to find a missing side
  - The second version is a rearrangement of this and can be used to find a missing angle
- $\cos 90^\circ = 0$  so if  $C = 90^\circ$  this becomes **Pythagoras' Theorem**

### How can we use the cosine rule to find missing side lengths or angles?

- The cosine rule can be used when you have two sides and the angle between them or all three sides
- Always **start by labelling your triangle** with the angles and sides
  - Remember the sides with the lower-case letters are **opposite** the angles with the equivalent upper-case letters
- As the formula uses  $C$  for the known angle, or the angle being found, you can choose to **relabel** the diagram to match this
  - Remember to also relabel the sides, so that side  $c$  is opposite angle  $C$ , and so on
- Use the formula  $c^2 = a^2 + b^2 - 2ab\cos C$  to find an unknown side
- Use the formula  $\cos C = \frac{a^2 + b^2 - c^2}{2ab}$  to find an unknown angle
  - $C$  is the angle **between** sides  $a$  and  $b$
- Substitute the values you have into the formula and solve

#### Examiner Tip

- If you're using a calculator make sure that it is in the correct mode (degrees/radians)
- Remember to give your answers as exact values if you are asked to



Your notes

 **Worked example**

The following diagram shows triangle  $ABC$ .  $AB = 4.2$  km,  $BC = 3.8$  km,  $AC = 7.1$  km.

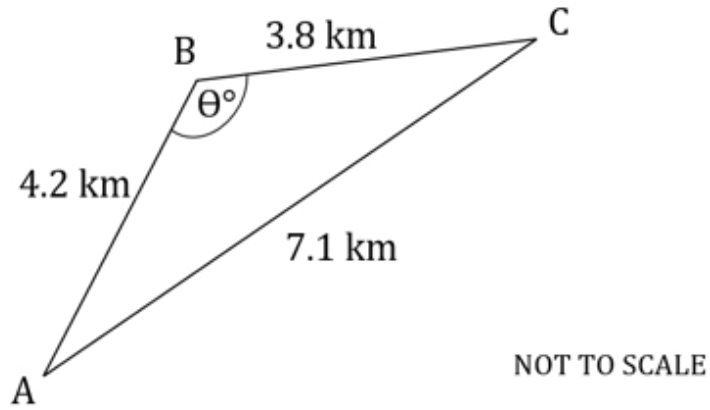

Calculate the value of  $\widehat{ABC}$ .





Your notes

Sketch the diagram and relabel the sides:

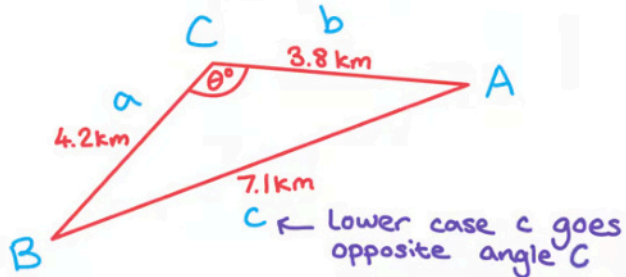

Using the cosine rule:

$$\cos C = \frac{a^2 + b^2 - c^2}{2ab}$$

← We are looking for an angle so this version is easier.

$$\cos \theta = \frac{4.2^2 + 3.8^2 - 7.1^2}{2(4.2)(3.8)}$$

$$\theta = \cos^{-1}\left(\frac{4.2^2 + 3.8^2 - 7.1^2}{2(4.2)(3.8)}\right)$$

$$= 125.04699\dots$$

$$\theta = 125^\circ \text{ (3 s.f.)}$$

## Area of a Triangle

### How do I find the area of a non-right triangle?

- The area of **any triangle** can be found using the formula

$$A = \frac{1}{2}ab\sin C$$

- Where  $C$  is the angle between sides  $a$  and  $b$
- This formula **is in the formula booklet**, you do not need to remember it
- Be careful to label your triangle correctly so that  $C$  is always the angle **between** the two sides
- $\sin 90^\circ = 1$  so if  $C = 90^\circ$  this becomes Area =  $\frac{1}{2} \times$  base  $\times$  height



Your notes



Your notes

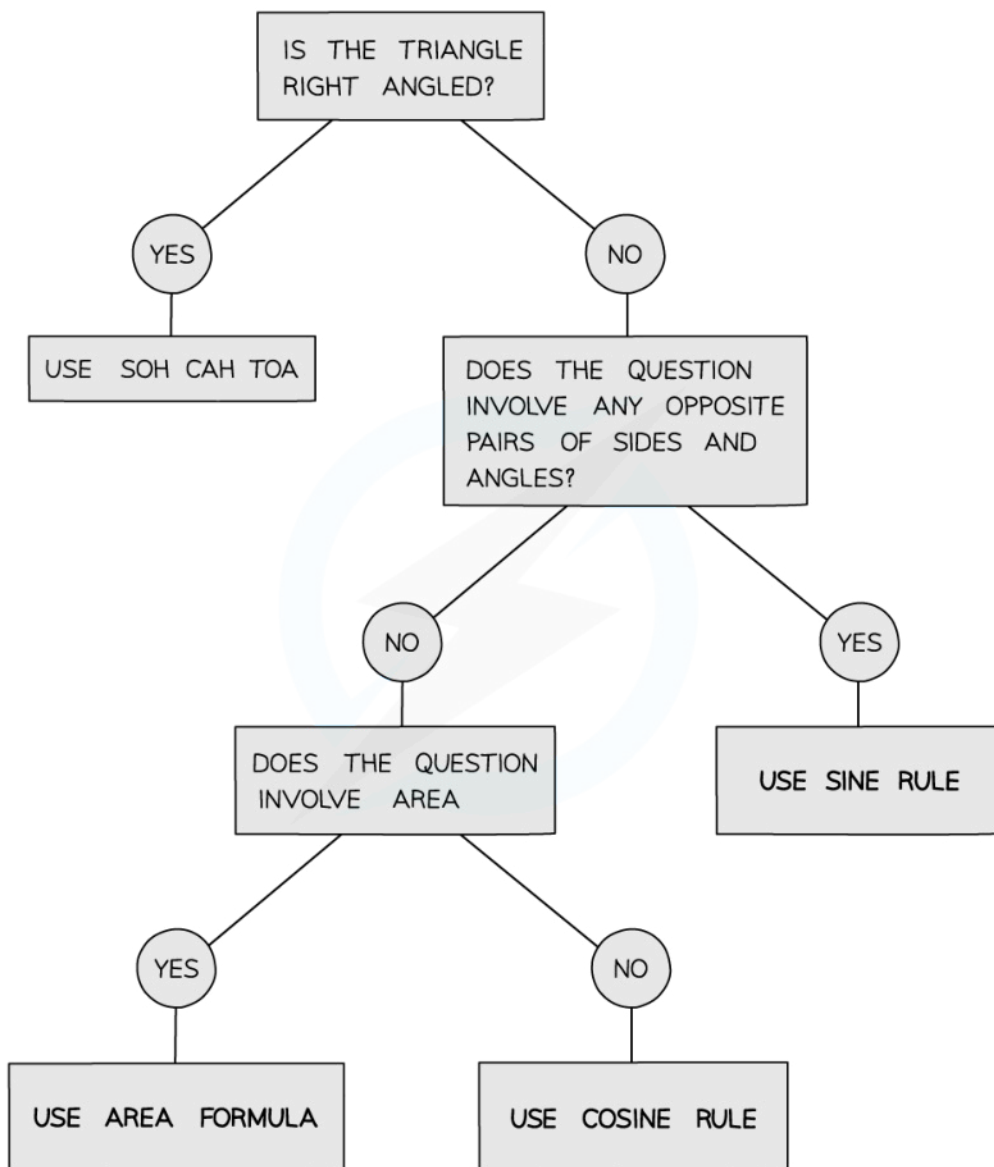

Copyright © Save My Exams. All Rights Reserved

 **Examiner Tip**

- If you're using a calculator make sure that it is in the correct mode (degrees/radians)
- Remember to give your answers as exact values if you are asked too



Your notes

 **Worked example**

The following diagram shows triangle  $ABC$ .  $AB = 32 \text{ cm}$ ,  $AC = 1.1 \text{ m}$ ,  $\widehat{BAC} = 74^\circ$ .

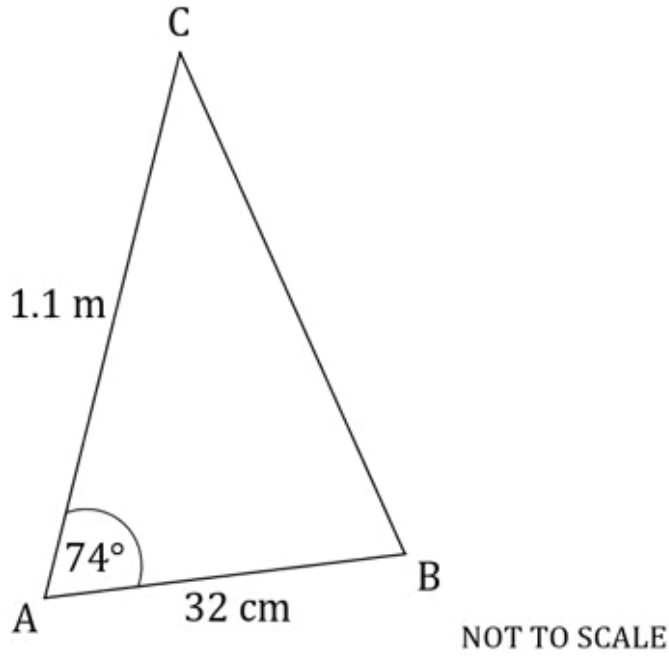

Calculate the area of triangle.



Your notes

Label the sides of the triangle:

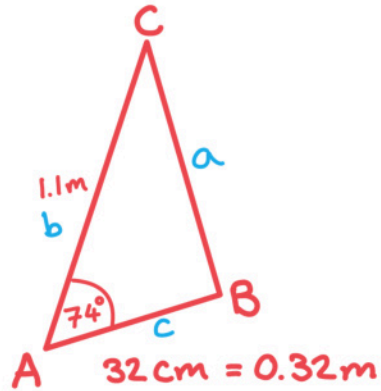

↪ change all units to be the same

Area of a triangle:  $A = \frac{1}{2}absinC$

$$A = \frac{1}{2}(1.1)(0.32)\sin 74^\circ$$

$$A = 0.169 \text{ m}^2$$



Your notes

### 3.3.3 Applications of Trigonometry & Pythagoras

## Bearings

### What are bearings?

- **Bearings** are a way of describing and using **directions** as **angles**
- They are specifically defined for use in navigation because they give a precise **location** and/or **direction**

### How are bearings defined?

- There are **three rules** which must be followed every time a bearing is defined
  - They are **measured** from the **North** direction
    - An arrow showing the North line should be included on the diagram
  - They are **measured clockwise**
  - The angle is always written in **3 figures**
    - If the angle is less than  $100^\circ$  the first digit will be a zero

### What are bearings used for?

- Bearings questions will normally involve the use of Pythagoras or trigonometry to find missing distances (lengths) and directions (angles) within navigation questions
  - You should always **draw a diagram**
- There may be a scale given or you may need to consider using a scale
  - However normally in IB you will be using triangle calculations to find the distances
- Some questions may also involve the use of angle facts to find the missing directions
- To answer a question involving **drawing bearings** the following steps may help:
  - STEP 1: Draw a diagram adding in any points and distances you have been given
  - STEP 2: Draw a North line (arrow pointing vertically up) at the point you wish to measure the bearing **from**
    - If you are given the bearing **from A to B** draw the North line at **A**
  - STEP 3: Measure the angle of the bearing given **from the North line** in the **clockwise direction**
  - STEP 4: Draw a line and add the point B at the given distance
- You will likely then need to use trigonometry to calculate the shortest distance or another given distance



### Examiner Tip

- **Always** draw a big, clear diagram and annotate it, be especially careful to label the angles in the correct places!



Your notes

**Worked example**

The point B is 7 km from A on a bearing of  $105^\circ$ . The distance from B to C is 5 km and the bearing from B to C is  $230^\circ$ . Find the distance from A to C.

Always start with a diagram:

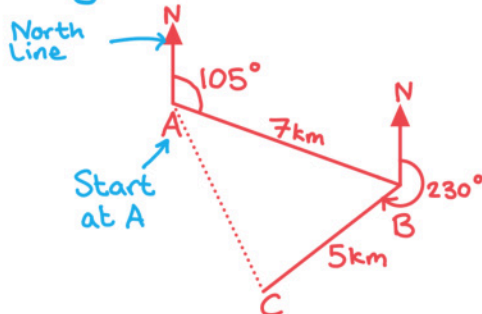

Fill in the angles you can on the diagram



We have two sides and the angle between them so we can use the cosine rule for the third side

$$c^2 = a^2 + b^2 - 2ab \cos C$$

$$AC^2 = 7^2 + 5^2 - 2(7)(5) \cos (55^\circ)$$

$$= 33.849\dots$$

$AC = 5.82 \text{ km (3 s.f.)}$



Your notes

## Elevation & Depression

### What are the angles of elevation and depression?

- If a person looks at an **object** that is not on the same horizontal line as their eye-level they will be looking at either an angle of **elevation** or **depression**
  - If a person looks **up** at an object their line of sight will be at an **angle of elevation** with the horizontal
  - If a person looks **down** at an object their line of sight will be at an **angle of depression** with the horizontal
- Angles of elevation and depression are measured **from the horizontal**
- **Right-angled trigonometry** can be used to find an angle of elevation or depression or a missing distance
- Tan is often used in real-life scenarios with angles of elevation and depression
  - For example if we know the distance we are standing from a tree and the angle of elevation of the top of the tree we can use Tan to find its height
  - Or if we are looking at a boat at to sea and we know our height above sea level and the angle of depression we can find how far away the boat is

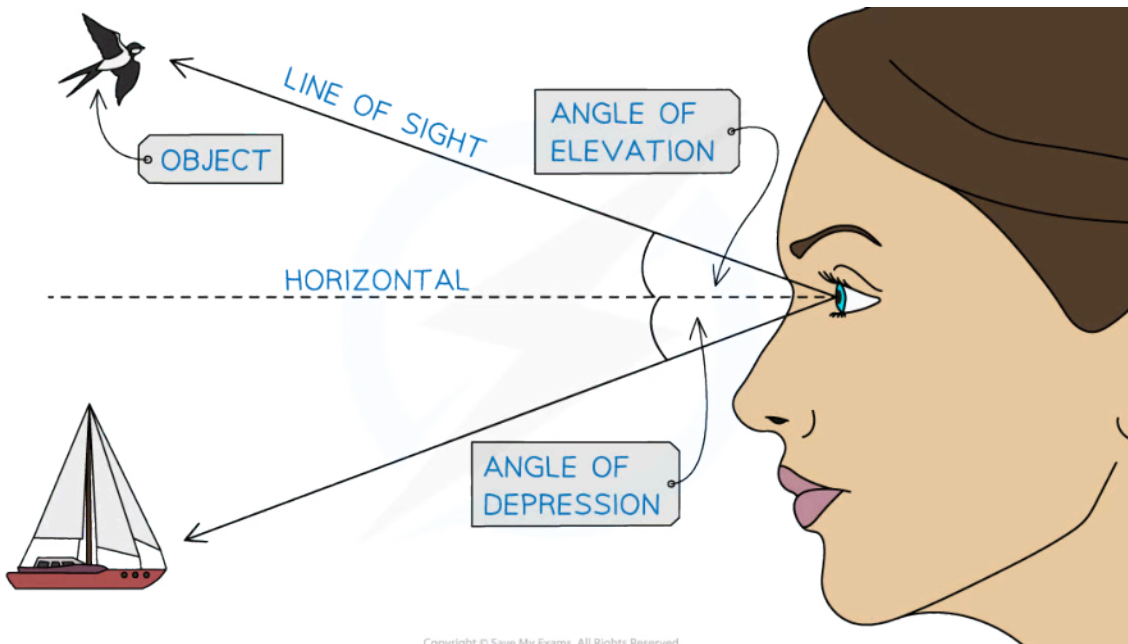

### Examiner Tip

- It may be useful to draw more than one diagram if the triangles that you are interested in overlap one another





Your notes

 **Worked example**

A cliff is perpendicular to the sea and the top of the cliff stands 24 m above the level of the sea. The angle of depression from the cliff to a boat at sea is  $35^\circ$ . At a point  $X$  m up the cliff is a flag marker and the angle of elevation from the boat to the flag marker is  $18^\circ$ .

- a) Draw and label a diagram to show the top of the cliff, T, the foot of the cliff, F, the flag marker, M, and the boat, B, labelling all the angles and distances given above.

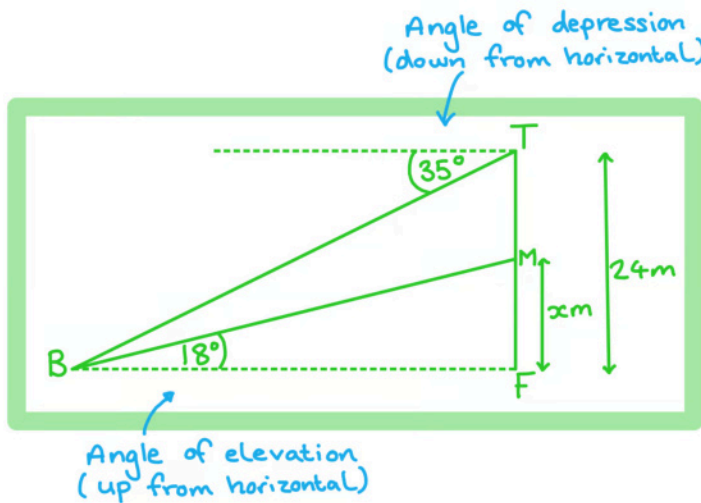

- b) Find the distance from the boat to the foot of the cliff.



Your notes

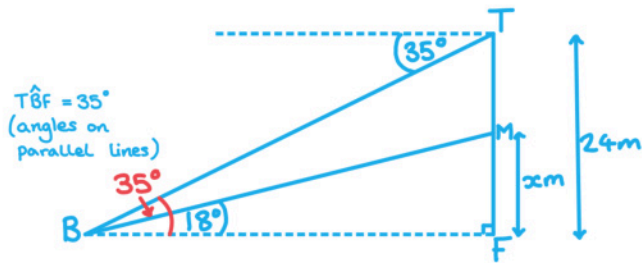

Consider triangle TBF

SOHCAHTOA

we have opposite and adjacent so use Tan

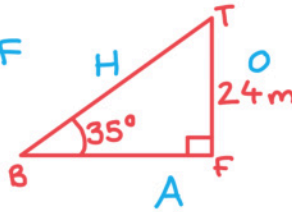

$$\tan 35^\circ = \frac{24}{BF}$$

$$BF = \frac{24}{\tan 35^\circ}$$

$$BF = 34.3\text{m (3s.f.)}$$

- c) Find the value of X.



Your notes



Consider triangle FBM

SOHCAHTOA  
we have opposite and adjacent so use Tan

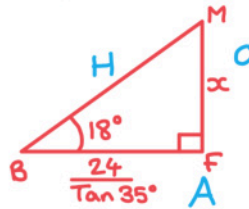

$$\tan 18^\circ = \frac{x}{\left(\frac{24}{\tan 35^\circ}\right)}$$

$$x = \tan 18^\circ \times \left(\frac{24}{\tan 35^\circ}\right)$$

$$= 11.136\dots$$

$$x = 11.1 \text{ m (3s.f.)}$$



Your notes

## Constructing Diagrams

### What diagrams will I need to construct?

- In IB you will be expected to construct diagrams based on information given
- The information will include **compass directions, bearings, angles**
  - Look out for the **plane** the diagram should be drawn in
  - It will either be **horizontal** (something occurring at sea or on the ground)
  - Or it will be **vertical** (including height)
- Work through the statements given in the instructions systematically

### What do I need to know?

- Your diagrams will be sketches, they do not need to be accurate or to scale
  - However the more accurate your diagram is the easier it is to work with
- Read the full set of instructions once before beginning to draw the diagram so you have a rough idea of where each object is
- Make sure you know your **compass directions**
  - **Due east** means on a **bearing of  $090^\circ$** 
    - Draw the line directly to the right
  - **Due south** means on a **bearing of  $180^\circ$** 
    - Draw the line vertically downwards
  - **Due west** means on a **bearing of  $270^\circ$** 
    - Draw the line directly to the left
  - **Due north** means on a **bearing of  $360^\circ$  (or  $000^\circ$ )**
    - Draw the line vertically upwards
- Using the above bearings for compass directions will help you to estimate angles for other bearings on your diagram

#### Examiner Tip

- Draw your diagrams in pencil so that you can easily erase any errors



Your notes

 **Worked example**

A city at B is due east of a city at A and A is due north of a city at E. A city at C is due south of B.

The bearing from A to D is  $155^\circ$  and the bearing from D to C is  $30^\circ$ .

The distance  $AB = 50$  km, the distances  $BC = CD = 30$  km and the distances  $DE = AE = 40$  km.

Draw and label a diagram to show the cities A, B, C, D and E and clearly mark the bearings and distances given.

