

# HL IB Business Management



Your notes

## 6.1 The Business Management Toolkit

### Contents

- \* SWOT Analysis
- \* Ansoff Matrix
- \* STEEPLE Analysis
- \* Boston Consulting Group (BCG) Matrix
- \* Business Plan
- \* Decision Trees
- \* Descriptive Statistics
- \* Circular Business Models
- \* Force Field Analysis
- \* Gantt Charts
- \* Hofstede's Cultural Dimensions
- \* Porter's Generic Strategies
- \* Contribution
- \* Critical Path Analysis
- \* Simple Linear Regression



Your notes

## SWOT Analysis

### Understanding SWOT Analysis

- SWOT Analysis is an analytical tool used by businesses to identify
  - Internal **strengths** and **weaknesses**
  - External **opportunities** and **threats**
- Effective SWOT analysis can help senior managers to **understand the current business position** and **future changes that may occur** so that **appropriate strategic decisions** may be made

#### Factors Often Considered in a SWOT Analysis

STRENGTHS	WEAKNESSES
<ul style="list-style-type: none"> <li><b>What the business is good at</b> For example:                             <ul style="list-style-type: none"> <li>Qualities that separate the business from rivals</li> <li>Internal resources such as skilled staff or a particular innovation</li> <li>Possession of assets such as capital, patents or intellectual property</li> <li>A loyal customer base</li> <li>Effective leadership</li> </ul> </li> </ul>	<ul style="list-style-type: none"> <li><b>What the business does poorly</b> For example:                             <ul style="list-style-type: none"> <li>Ways in which the business lags behind competitors</li> <li>Resource or capital limitations including labour and finance</li> <li>Lack of a competitive advantage</li> <li>Lack of a <b>unique selling proposition (USP)</b></li> <li>Poor online presence</li> </ul> </li> </ul>
OPPORTUNITIES	THREATS
<ul style="list-style-type: none"> <li><b>Options a business may exploit to enjoy further success</b>  For example:</li> </ul>	<ul style="list-style-type: none"> <li><b>Hazards that have the potential to damage business performance</b>  For example:</li> </ul>

- |  |  |
|--|--|
| <ul style="list-style-type: none"><li>▪ Developing markets for specific products become apparent</li><li>▪ Few competitors exist</li><li>▪ A changing legal or political environment positively impacts on business processes and decisions</li><li>▪ Social or <b>technological developments</b> create an emerging need for the businesses products</li><li>▪ Economic indicators becoming more favourable</li><li>▪ A potential for positive media coverage of the business</li></ul> | <ul style="list-style-type: none"><li>▪ New or emerging competitors are <b>gaining market share</b></li><li>▪ A changing legal or political environment negatively impacting on business processes and decisions</li><li>▪ Social or technological developments threaten <b>obsolescence of products</b></li><li>▪ Economic indicators becoming less favourable</li><li>▪ Negative press coverage</li><li>▪ Changing customer attitudes towards the business</li></ul> |
|--|--|



Your notes

### Example of a Swot Analysis

- Once a SWOT Analysis has been completed by a business, appropriate decisions can be made to improve performance
  - Strengths should be **harnessed**
  - Weaknesses should be **eliminated**
  - Opportunities should be **seized**
  - Threats should be **mitigated**



Your notes

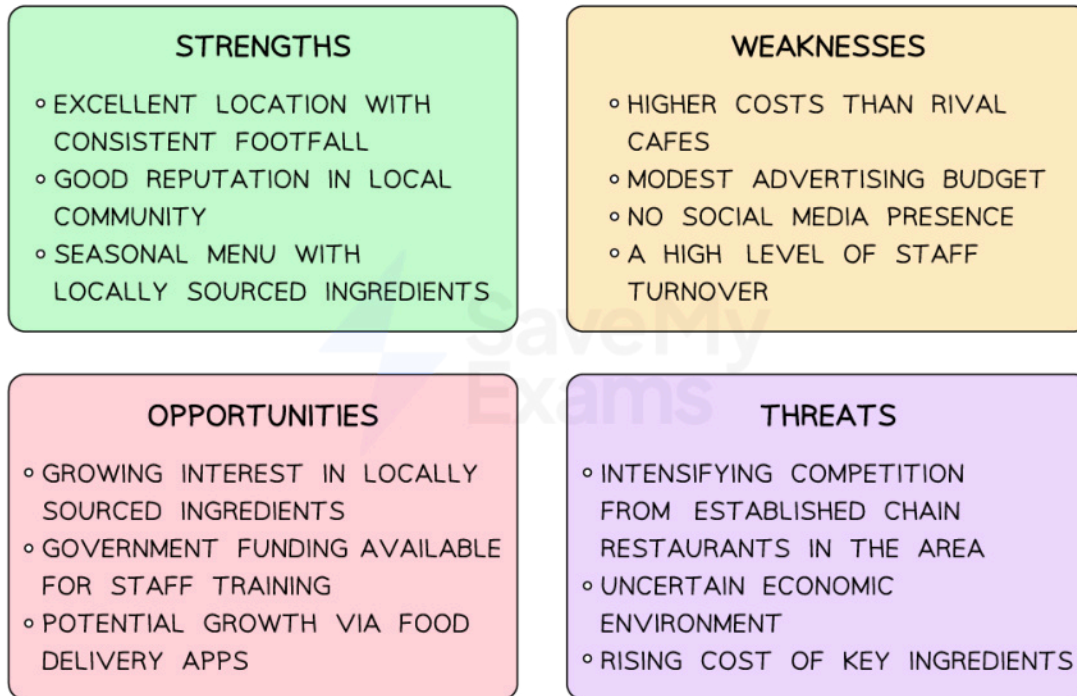

Copyright © Save My Exams. All Rights Reserved

### **An example of a SWOT Analysis for a small cafe**

- Having compiled the SWOT Analysis the owner of the cafe may conclude that the business should
  - Seize the **opportunity** presented by the growing interest in locally sourced ingredients by promoting the cafe's **strength** of its seasonal, locally sourced menu, especially given the **threat** from large competitors
  - Make use of the government funding for staff training to attempt to reduce staff turnover
  - Increase the volume of sales to a geographically wider target market by teaming up with delivery apps and establishing an inexpensive social media presence



Your notes

## Evaluating the SWOT Analysis Tool

- The usefulness of SWOT analysis depends on a range of factors, not least including the experience of the person doing the analysis

### Factors Affecting the Usefulness of SWOT Analysis

Factor	Explanation
<b>The quality &amp; relevance of data used</b>	<ul style="list-style-type: none"> <li>▪ The <b>accuracy</b> and <b>reliability</b> of the data used for SWOT analysis greatly influence its usefulness</li> <li>▪ If the information used for analysis is <b>outdated</b>, <b>incomplete</b> or <b>biased</b> it can lead to flawed conclusions and ineffective decision-making</li> </ul>
<b>Objectivity &amp; bias</b>	<ul style="list-style-type: none"> <li>▪ SWOT analysis requires a <b>fair and unbiased</b> assessment of the organisation's internal and external factors</li> <li>▪ If the analysis is influenced by personal biases, preconceived notions or subjective opinions it can undermine the usefulness of the analysis</li> </ul>
<b>Depth of analysis</b>	<ul style="list-style-type: none"> <li>▪ Superficial analysis may <b>overlook important factors</b> or fail to capture the complexity of the organisation's environment</li> <li>▪ A comprehensive and thorough analysis can provide more accurate insights and improve the usefulness of SWOT analysis</li> </ul>
<b>Stakeholder involvement</b>	<ul style="list-style-type: none"> <li>▪ SWOT analysis should involve <b>input from various stakeholders</b> within the organisation, including employees, managers, customers, suppliers, and industry experts</li> <li>▪ Their <b>diverse perspectives</b> can provide a broader understanding of the organisation's strengths, weaknesses, opportunities and threats thus increasing the usefulness of the analysis</li> </ul>

**Dynamic nature of the environment**

- As **market conditions, technology and consumer preferences change over time** the relevance of identified strengths, weaknesses, opportunities and threats may also shift
- **Regular updates and revisions** to the analysis are necessary to ensure its usefulness



Your notes



Your notes

## Ansoff Matrix

### Development of Corporate Strategy

- Ansoff's Matrix is a tool for businesses who have a **growth objective**
- It is used to identify an **appropriate corporate strategy** and understand the **level of risk** associated with the chosen strategy
- The model considers four elements, which are broken down into two categories
  - **The market** - existing and new markets
  - **The product** - existing and new products

### Diagram of the Ansoff Matrix

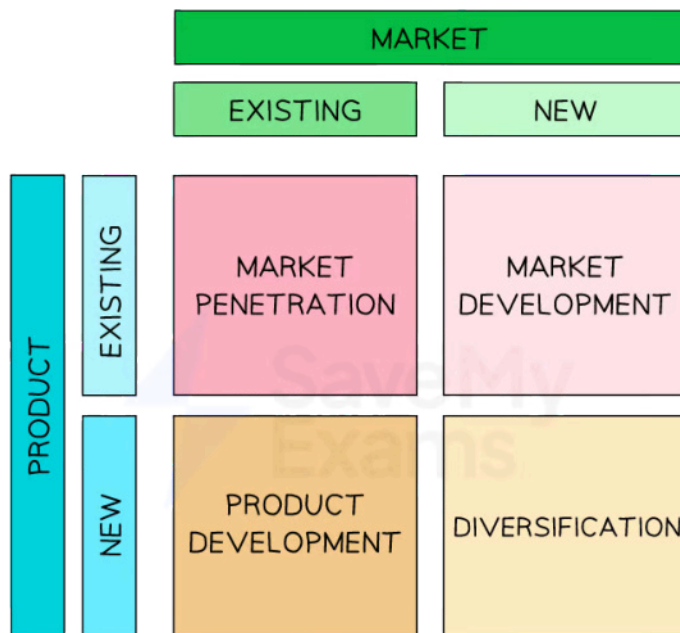

Copyright © Save My Exams. All Rights Reserved

**Ansoff's Strategic Matrix**

### Market penetration

- The **least risky** strategy to achieve growth is to pursue a strategy of **market penetration**
  - This involves **selling more products to existing customers** by encouraging
    - **More regular use** of the product
    - **Increased usage** of the product
    - Brand loyalty of customers

### Market development

- **Market development** involves finding and exploiting **new market opportunities for existing products** by
  - Entering new markets **abroad**
  - **Repositioning** the product by selling to different **customer profiles** (selling to other businesses as well as direct to consumers)
  - Seeking **complementary locations**
    - E.g. M&S Food has achieved significant growth since teaming up with fuel retailers such as BP and Applegreen and providing express retail outlets

## Product development

- **Product Development** involves selling **new or improved products to existing customers** by
  - Developing **new versions or upgrades** of existing successful products
  - **Redesigning packaging** and aesthetic features
  - **Relaunching heritage products** at commercially convenient intervals
    - E.g. Lindt relaunches Christmas-themed products each year, often with a subtle design change, to recapture the interest of customers

## Diversification

- **Diversification** is the **most risky** growth strategy as it involves **targeting new customers with entirely new or redeveloped products**
  - Examples of diversification include
    - UK supermarket **Tesco** launching a range of financial products including current accounts and credit cards
    - Café chain **Greggs** launching a range of **themed clothing products**



Your notes





Your notes

## STEEPLE Analysis

### STEEPLE Analysis

- STEEPLE analysis examines factors outside of the business (**external**) that are likely to impact the business
- STEEPLE analysis can **support effective decision-making** as senior managers will gain a better **understanding of the complex context** within which the business operates
- STEEPLE Analysis is particularly useful in the following situations
  - **Product development**  
STEEPLE analysis can provide guidance on whether the business should keep selling a product to a particular region
  - **Workforce planning**  
STEEPLE analysis can help identify emerging business changes that can affect the future job market
  - **Strategic business planning**  
STEEPLE analysis is beneficial when starting a business planning process as it provides a detailed guide that includes growth targets, brand positioning, and potential risks
  - **Marketing planning**  
STEEPLE analysis provides a business with information on external factors which could be used to create a marketing strategy

#### An Explanation of the STEEPLE Factors

External Factor	Explanation	Examples
Social	<ul style="list-style-type: none"> <li>▪ The extent to which <b>personal attitudes and values, culture and demographic change</b> are expected to affect the business including                             <ul style="list-style-type: none"> <li>▪ Social mobility</li> <li>▪ Education</li> <li>▪ Ethics &amp; Religion</li> <li>▪ Migration</li> <li>▪ Health profile</li> <li>▪ Population growth and demographic structure</li> </ul> </li> </ul>	<ul style="list-style-type: none"> <li>▪ Greater numbers of people graduating from university have increased the quality of workers available to European businesses</li> <li>▪ A more health-conscious population provides a lucrative market for businesses selling fitness and lifestyle products</li> </ul>



Your notes

<p><b>Technological</b></p>	<ul style="list-style-type: none"> <li>▪ The extent to which <b>technological change and innovation</b> are expected to impact the business including             <ul style="list-style-type: none"> <li>▪ Research &amp; development</li> <li>▪ Production and distribution processes and efficiency</li> <li>▪ Quality and new materials</li> <li>▪ Intellectual property</li> <li>▪ Online presence</li> <li>▪ The technology used in communication</li> </ul> </li> </ul>	<ul style="list-style-type: none"> <li>▪ Developments in communication technology have reduced the need for business travel</li> <li>▪ Rapid developments in technology have reduced the length of product life cycles and increased the need for businesses to carry out ongoing research, development and innovation</li> </ul>
<p><b>Economic</b></p>	<ul style="list-style-type: none"> <li>▪ The extent to which <b>economic indicators</b> are expected to directly impact business performance including             <ul style="list-style-type: none"> <li>▪ Inflation</li> <li>▪ Exchange rates</li> <li>▪ Cost of living</li> <li>▪ The stage of the Business Cycle and GDP growth</li> <li>▪ Unemployment levels</li> </ul> </li> </ul>	<ul style="list-style-type: none"> <li>▪ High rates of fuel and food inflation in parts of Europe have reduced the level of disposable income for most households</li> <li>▪ A historically low unemployment level has made recruitment more challenging for many EU businesses</li> </ul>
<p><b>Environmental</b></p>	<ul style="list-style-type: none"> <li>▪ The extent to which changes in <b>attitudes and government policy</b> towards environmental protection as well as <b>the impact of global warming</b> expected to impact the business including             <ul style="list-style-type: none"> <li>▪ Changing infrastructure - for example in favour of green transportation networks</li> <li>▪ <b>Energy availability</b> &amp; cost</li> <li>▪ Disposal of materials</li> <li>▪ Changes in climate and weather patterns</li> <li>▪ Air quality</li> </ul> </li> </ul>	<ul style="list-style-type: none"> <li>▪ Increased interest in environmentally responsible and ethically-produced goods has created new markets for businesses to exploit</li> <li>▪ Strict rules on the disposal of commercial waste have increased costs for businesses</li> </ul>
<p><b>Political</b></p>	<ul style="list-style-type: none"> <li>▪ The extent to which <b>local and national government</b> is expected to influence the business including             <ul style="list-style-type: none"> <li>▪ Government stability and relationships with key trading partners</li> <li>▪ Tax regulations</li> <li>▪ Trade restrictions</li> </ul> </li> </ul>	<ul style="list-style-type: none"> <li>▪ The UK's decision to leave the EU in 2016 has led to the <b>reintroduction of trading restrictions</b> for British businesses importing goods from suppliers in Europe</li> <li>▪ The reduced level of threat from terrorism in Ireland has helped to</li> </ul>



Your notes

	<ul style="list-style-type: none"> <li>Political Ideology and attitude to Business</li> <li>Fiscal policy</li> <li>National security status</li> <li>Investment in public services</li> </ul>	<p>boost tourism</p>
<p><b>Legal</b></p>	<ul style="list-style-type: none"> <li>The extent to which <b>changes in law and regulations</b> are expected to impact the business including             <ul style="list-style-type: none"> <li>Taxation</li> <li>Employment</li> <li>Advertising</li> <li>Health &amp; Safety</li> <li>Compliance and 'red tape' created by regulatory bodies such as the <b>Health and Safety Executive</b></li> </ul> </li> </ul>	<ul style="list-style-type: none"> <li>Changes to the level of tax levied on high sugar products (sodas) across Europe has increased selling prices and prompted some businesses to <b>redevelop their product</b> to reduce the sugar content</li> <li>A rise in the level of the minimum wage increases business staffing costs</li> </ul>
<p><b>Ethical</b></p>	<ul style="list-style-type: none"> <li>The extent to which moral principles ought to be considered in the decision-making process, for example             <ul style="list-style-type: none"> <li>Being <b>truthful</b> about products and using <b>responsible</b> marketing practices</li> <li><b>Paying staff and suppliers</b> on time and in full</li> <li>Trading <b>fairly</b></li> <li>Being <b>accurate and realistic</b> about financial performance</li> <li>Avoiding <b>discrimination</b></li> </ul> </li> </ul>	<ul style="list-style-type: none"> <li>Many supermarkets have implemented '<b>above and beyond</b>' policies related to the sale of alcohol and tobacco and require customers to prove that they are significantly older than the minimum legal age of sale</li> </ul>



Your notes

## Boston Consulting Group (BCG) Matrix

### Boston Matrix & the Product Portfolio

- The Boston Consulting Group (BCG) Matrix is a tool used by businesses to **analyse their product portfolio** and make **strategic decisions** about each product
- The matrix classifies products into four categories based on their market share and the market growth rate
  - Cash Cow
  - Problem Child/Question Mark
  - Star
  - Dog

### Diagram of the Boston Consulting Group Matrix

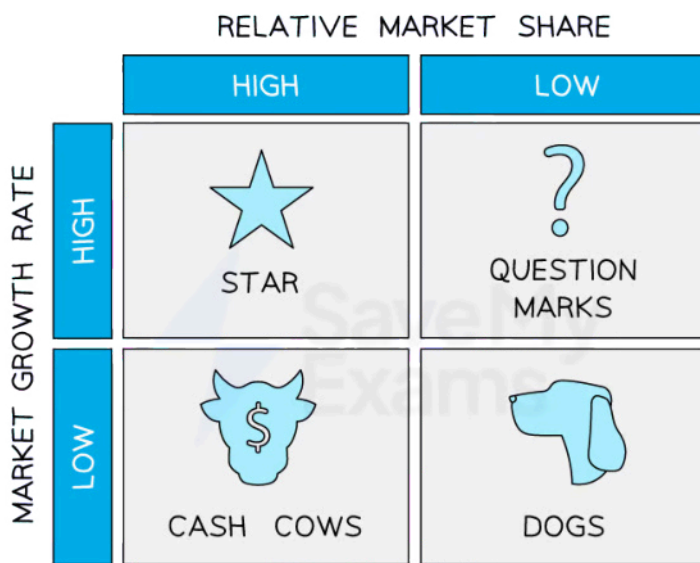

**Products in the Boston Matrix are classified according to their market share and the growth rate in the market as a whole**

- By categorising products into these categories, businesses can **allocate resources more effectively**, optimise their cash flow and develop marketing strategies that align with the product's potential

### The Implications of the Boston Matrix for the Cash-flow and Marketing Strategy



Your notes

Product Type	Explanation	Implications
Cash Cow	<ul style="list-style-type: none"> <li>Cash cows are products with a <b>high market share in a mature market</b> (the entire market is no longer growing)</li> </ul>	<ul style="list-style-type: none"> <li>They generate <b>significant positive cash flow</b> but have low growth potential</li> <li>The business invests minimal resources in cash cows as they are seen as stable sources of income</li> <li>Marketing efforts focus on <b>maintaining their market share</b> and profitability</li> <li>Cash cows are valuable assets and can be used to fund the development of new products</li> </ul>
Problem Child/Question Mark	<ul style="list-style-type: none"> <li>Problem child or question mark products have a <b>low market share in a high-growth market</b></li> <li>These products have the potential to become stars if the company invests in their development</li> </ul>	<ul style="list-style-type: none"> <li>There is often a <b>negative cash flow</b> as businesses usually invest in problem child products to increase their market share and <b>turn them into stars</b></li> <li>If the investment does not result in growing the business may discontinue the product</li> <li>Marketing efforts focus on <b>increasing their market share</b> and brand recognition</li> </ul>
Star	<ul style="list-style-type: none"> <li>Star products have a <b>high market share in a high-growth market</b></li> <li>The company typically invests in stars to maintain or increase their market share</li> </ul>	<ul style="list-style-type: none"> <li>They generate <b>significant positive cash flow</b> and have the potential for continued growth</li> <li>Marketing efforts focus on building <b>brand recognition</b>, increasing market share, and maintaining profitability</li> <li>Stars are valuable assets and the business should focus on maximising their potential</li> </ul>
Dog	<ul style="list-style-type: none"> <li>Dog products have a <b>low market share in a low-growth market</b></li> </ul>	<ul style="list-style-type: none"> <li>They generate <b>little revenue</b> for the company and have no growth potential</li> <li>Businesses often <b>move away (divest)</b> from these to focus on more profitable products</li> <li>Marketing efforts for dog products are minimal or zero</li> </ul>

## Business Plan



Your notes

### Business Plan

- A business plan sets out **key aspects of a business** and **how the owners intend it to develop**
- The main aim of producing a business plan is to **reduce the risk** associated with starting a new business and help the owners to **raise finance**
- Producing a business plan forces the owner to think about every aspect of the business **before they start** which should **reduce the risk** of failure
  
- A well-written business plan can **help a business to obtain finance**
  - Lenders (e.g. banks) and other investors will be able to explore the plan and **make an informed decision** about whether the business is credible and worth the financial risk
  - Investors (e.g. [venture capitalists](#)) will use the business plan to explore whether there is an opportunity to **increase the value of their investment** and make a worthwhile profit
  - The business, having carried out research to support the plan, will be **well-informed about the potential problems and chance of success** and can select the most appropriate source of finance based on this information

### Diagram Showing the Elements of a Business Plan



Your notes

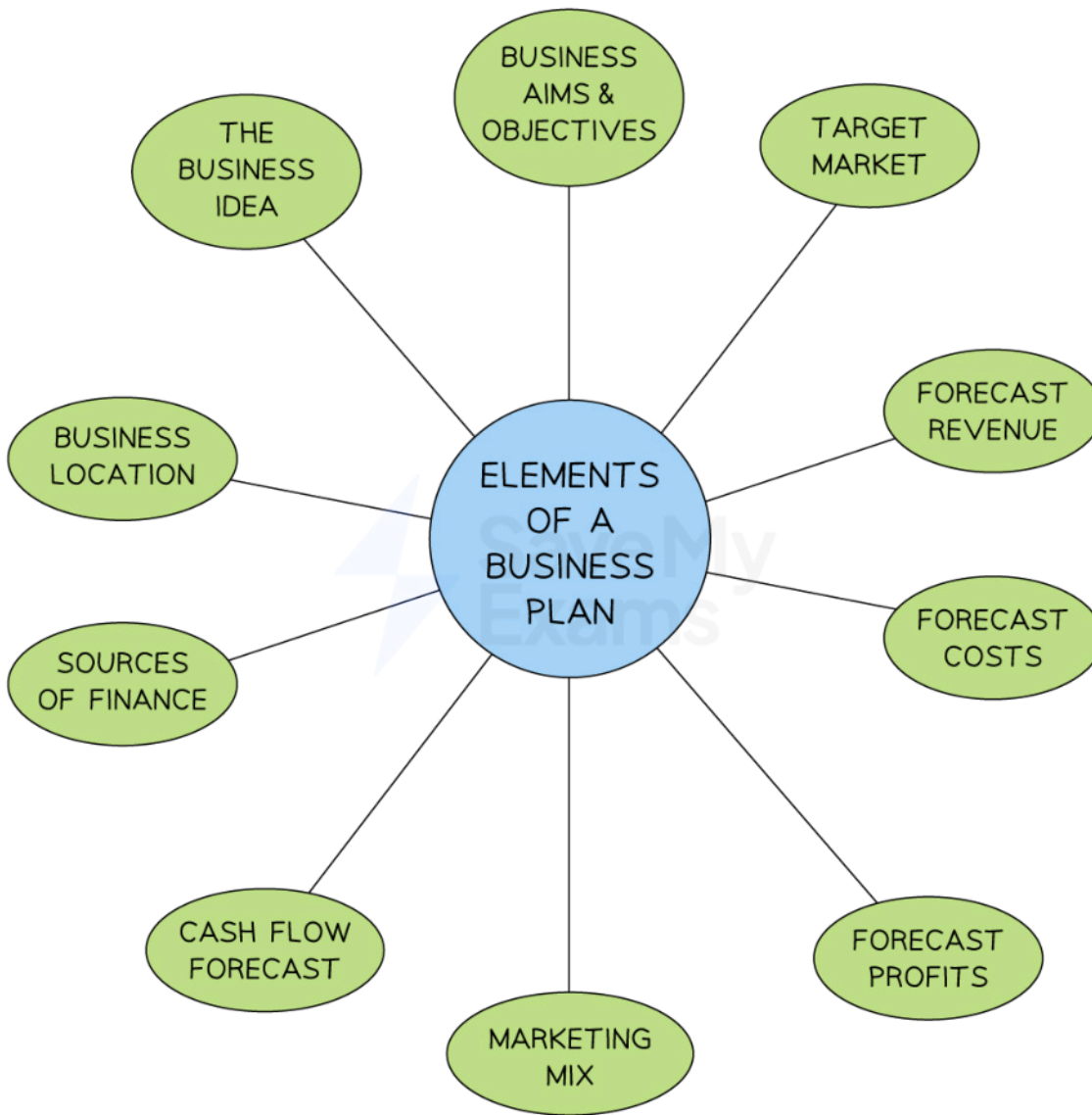

Copyright © Save My Exams. All Rights Reserved

**Common elements of a business plan**

- Having carried out research to support the plan, the business will be **well-informed about the potential problems and chance of success** and can select the most appropriate **source of finance** based on this information
- A business plan should be a **regularly-updated working document**
  - As the business grows plans are likely to change as it faces new threats and opportunities

**Key Elements in a Business Plan**



Your notes

Element	Explanation
Executive Summary	<ul style="list-style-type: none"> <li>This section provides an <b>overview of the business idea</b>, its unique selling proposition, target market, and financial projections                             <ul style="list-style-type: none"> <li>It should be <b>concise</b> yet compelling enough to grab the reader's attention</li> </ul> </li> </ul>
Company Description	<ul style="list-style-type: none"> <li>A description of the business mission, vision, and values</li> <li>Information about the <b>legal structure</b>, location and any unique advantages or intellectual property the business may have</li> </ul>
Market Analysis	<ul style="list-style-type: none"> <li>A thorough analysis of the target market including its size, growth potential and key trends</li> <li>Identification of <b>target customers</b> and their needs</li> <li>A <b>competitor analysis</b> to understand their strengths and weaknesses</li> </ul>
Products or Services	<ul style="list-style-type: none"> <li>A detailed explanation of the <b>products/services the business will offer</b>, highlighting their features, benefits and any competitive advantages they may have</li> </ul>
Marketing & Sales Strategy	<ul style="list-style-type: none"> <li>A description of the intended marketing and sales approach including marketing channels, <b>pricing strategy</b> and promotional tactics</li> <li>A description of how customers will be attracted and their loyalty captured</li> </ul>
Organisation & Management	<ul style="list-style-type: none"> <li>An overview of the organisational structure of the business and the key members of the team including their qualifications, experience and responsibilities</li> </ul>
Operations & Implementation	<ul style="list-style-type: none"> <li>A description of how the business will operate on a day-to-day basis including the <b>production process</b>, stock management and any key partnerships or suppliers</li> </ul>
Financial Projections	<ul style="list-style-type: none"> <li>A detailed <b>financial forecast</b> for the business including <b>projected income statements</b>, balance sheets and cash flow statements</li> <li>An outline of funding requirements and any existing or potential sources of finance</li> </ul>
Risk Analysis	<ul style="list-style-type: none"> <li>A consideration of the <b>potential risks and challenges</b> the business may face and the intended strategies for mitigating them</li> </ul>



## Decision Trees



Your notes

### Decision Tree Diagrams

- A decision tree is a **visual, quantitative method** of tracing the outcomes of a decision so that **the most profitable decision can be identified**
  - **Research-based estimates** and **probabilities** are used to calculate likely outcomes
  - The **net gain from a decision** can be identified and used to consider whether an investment is worthwhile
- Using decision trees provides **several key advantages** to the decision making process
  - Constructing a decision tree diagram may **reveal options** that haven't previously been considered
  - Managers are forced to **consider the risks** associated with their choice, ahead of implementation
  - The quantitative approach requires **deep research** to be carried out
- The **key elements** in a decision tree diagram are
  - Decision points
  - Outcomes
  - Probabilities
  - Expected monetary values

### Diagram of a Decision Tree



Your notes

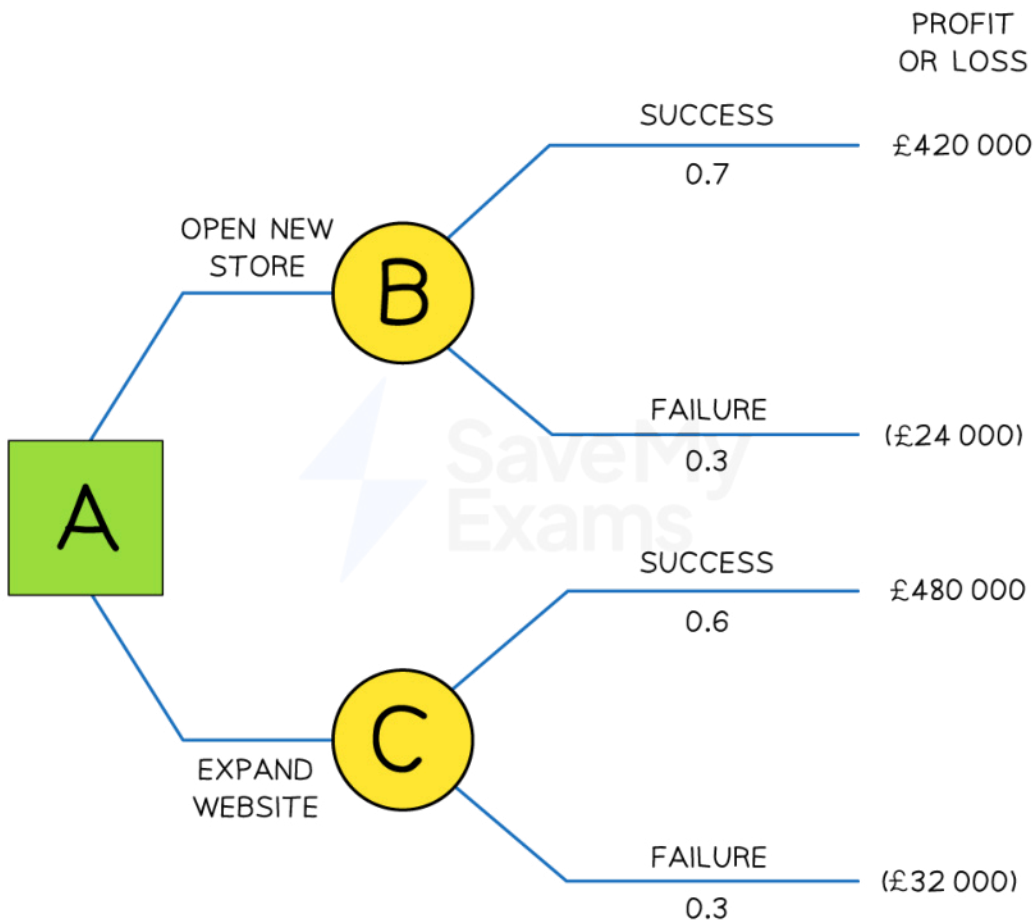

Copyright © Save My Exams. All Rights Reserved

**A simple decision tree based on the choice of whether to invest in opening a new store or expand its website**

### Decision points

- Points where **decisions** need to be made are called *Decision Points* and are represented by squares
  - Square A represents the fact that a choice is required on opening a new store or expanding the website

### Nodes

- Points where there are different **outcomes** are represented by circles are called *Nodes*
  - Circles B and C represent points at which the different options have a range of outcomes - success or failure

### Probabilities

- The **probability** or likelihood of each outcome is shown on the diagram

- A certain outcome has a probability of 1
- An impossible outcome has a probability of 0
  - Opening a new store has a 0.7 probability of success and a 0.3 probability of failure
  - Expanding the website has a 0.6 probability of success and a 0.4 probability of failure

### Expected monetary values

- The **monetary value** of each decision is based on the expected profit or loss of the outcome
  - If opening a new store is successful a £420,000 profit is expected
  - If opening a new store is unsuccessful a £24,000 loss is expected
  - If expanding the website is successful a £480,000 profit is expected
  - If expanding the website is unsuccessful a £32,000 loss is expected



Your notes



Your notes

 **Worked example**

- In some cases the decision tree diagram **provides expected revenues rather than profit or loss** for the range of outcomes
- In these diagrams **the costs related to each outcome are also provided**
- To calculate the expected value of each outcome **costs must be deducted from expected revenues**

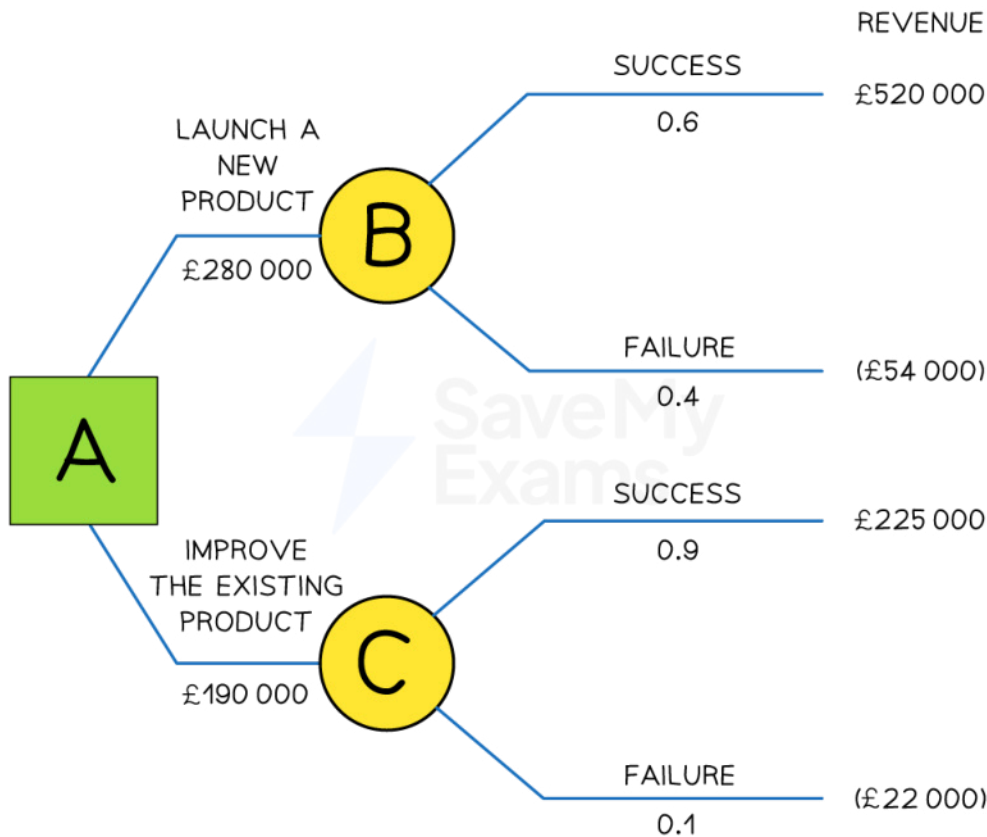

Copyright © Save My Exams. All Rights Reserved

**A decision tree based on a decision whether to launch a new product or improve an existing product**

- To calculate the **expected monetary value** of a decision where revenues and costs are included in the diagram  

$$(\text{Expected value of success} \times \text{Probability}) + (\text{Expected value of failure} \times \text{Probability}) - \text{Cost}$$
- The expected value of launching a new product is

$$(\text{£}520,000 \times 0.6) + (-\text{£}54,000 \times 0.4) - \text{£}280,000$$

$$= \text{£}312,000 + -\text{£}21,600 - \text{£}280,000$$

$$= \text{£}290,400 - \text{£}280,000$$

$$= \text{£ } 10,400$$

- The expected value of improving the existing product is  
 $(\text{£}225,000 \times 0.9) + (-\text{£}22,000 \times 0.1) - \text{£}190,000$

$$= \text{£}202,500 + -\text{£}2,200 - \text{£}190,000$$

$$= \text{£}200,300 - \text{£}190,000$$

$$= \text{£ } 10,300$$

- As the expected value of launching a new product is marginally higher at £10,400 than that of improving the existing product at £10,300, the business should choose the option to launch a new product
- In this case the decision tree has demonstrated that there is **little between the two options** and the business should **look at other factors** that may inform their decision



Your notes

## Calculating Expected Monetary Values

- To compare the options a business should take into account the **expected values of each decision** presented in the decision tree diagram
- To calculate the **expected monetary value** of a decision, the following formula is used  
(Expected value of success x Probability) + (Expected value of failure x Probability)
  
- Using the example above the expected value of opening a new store is  
 $(£420,000 \times 0.7) + (-£24,000 \times 0.3)$   
 $= £294,000 + -£7,200$   
 $= £286,800$
  
- Using the example above the expected value of expanding the website is  
 $(£480,000 \times 0.6) + (-£32,000 \times 0.4)$   
 $= £288,000 + -£12,800$   
 $= £275,200$
  
- As the expected value of opening a new store is higher at £286,800, than that of expanding the website at £275,200, based purely on financial terms the business **should choose the option to open a new store**



Your notes



Your notes

 **Worked example**

*Caramelac* is a lactose-free chocolate product manufactured by a large multinational confectionery business. In recent years increased competition from other well-known brands has started to impact on sales of the product and managers are determined to maintain *Caramelac*'s market share.

Market research has shown that the business has two options:

- a) Redevelop the product
- b) Create a new advertising campaign

The expected outcomes and the probabilities of success and failure are shown in the decision tree below

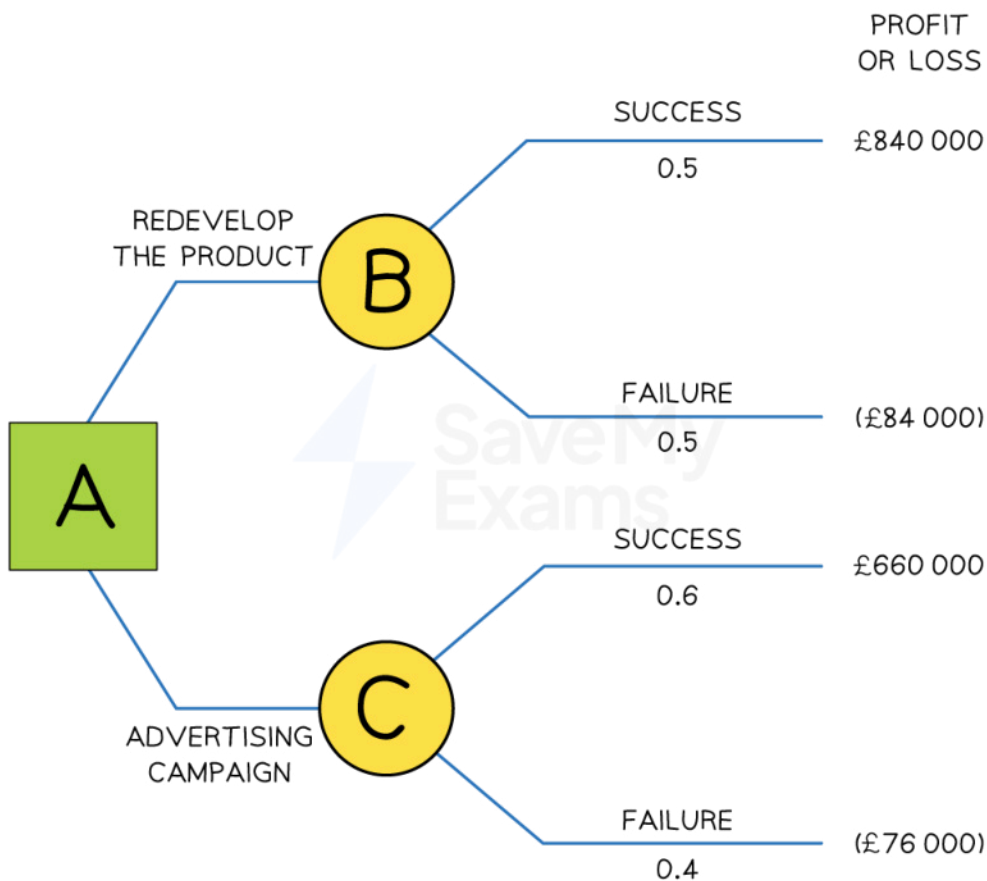

Copyright © Save My Exams. All Rights Reserved



Your notes

Calculate the expected values of each option and decide, on financial grounds, which option the *Caramelac*'s brand managers should choose. (6 marks)

**Step 1 – Calculate the expected value of redeveloping the product**

$$\begin{aligned} & (\text{£}840,000 \times 0.5) + (-\text{£}84,000 \times 0.5) \\ & = \text{£}420,000 + -\text{£}42,000 \\ & = \text{£}378,000 \quad \text{(2 marks)} \end{aligned}$$

**Step 2 – Calculate the expected value of the advertising campaign**

$$\begin{aligned} & (\text{£}660,000 \times 0.6) + (-\text{£}76,000 \times 0.4) \\ & = \text{£}396,000 + -\text{£}30,400 \\ & = \text{£}365,600 \quad \text{(2 marks)} \end{aligned}$$

**Step 3 – Interpret the outcomes and make a decision**

As the expected value of redeveloping the product is higher at £378,000 than that of the advertising campaign at £365,600 (1 mark), the business should choose the option to redevelop the product (1 mark).

 **Examiner Tip**

Expected values are not the same thing as profit or revenues generated by a choice. In the above example, launching a new product is expected to either generate a positive revenue figure of £520,000 or generate a negative revenue figure of £54,000. It is never forecast that a revenue figure of £200,300 will be achieved. This is purely a figure used in making the choice between this option and the alternative and does not represent the actual amount of revenue that is expected to be achieved.



## Limitations of Using Decision Trees

- Constructing decision trees that can support effective decision-making **requires skill** to avoid bias and take **significant amounts of time to gather reliable data**
- A decision tree is **constructed using estimates** which rarely take full account of **external factors** and **cannot include all possible eventualities**
- **Qualitative elements** such as human resource impacts are not considered which may **affect the probability of success** of a decision
- The **time lag** between the construction of a decision tree diagram and the implementation of the decision is likely to further affect the **reliability of the expected values**



Your notes

## Descriptive Statistics



Your notes

### The Usefulness of Descriptive Statistics

- **Descriptive statistics** are summary measures used to concisely describe key features of a dataset. They simplify complex data for easy interpretation and highlight essential characteristics
- Using descriptive statistics provides the following benefits:
  - Descriptive stats provide **a brief overview**
  - Enables **easy comparison** of diverse datasets, helping analyse trends or performance variations
  - Support **informed decision-making** by highlighting historical trends and patterns
  - Useful in **evaluating performance metrics**, from employee productivity to marketing success
  - Simplifies complex data for **effective communication** in presentations and reports

## Mean, Median, Mode & Standard Deviation

- Statistical analysis may include calculating the **average** of a given set of numerical data using one of three methods
  - The **mean** is commonly considered the true average - where all the numbers in a data set are added and then divided by the number of numbers
  - The **median** is the middle value in the list of numbers
  - The **mode** is the value that occurs most often in a set of data



Your notes



Your notes

### Worked example

RapidKleen kept a record of mobile vehicle valets carried out each day during a busy holiday period.

Find the mean, median, mode, and range of mobile valets during the period using the following data.

Day	1	2	3	4	5	6	7	8	9
No. of valets sold	13	18	13	14	13	16	14	21	13

[6 marks]

**Step 1: To calculate the mean, first add together each of the values**

$$13 + 18 + 13 + 14 + 13 + 16 + 14 + 21 + 13 = 135$$

**Step 2: Divide the total by the number of values**

$$135 \div 9 = 15$$

[2 marks]

Note that the mean in this case isn't a value from the original data set

This is a common result - you should not assume that your mean will be one of your original numbers and you should not be surprised when it isn't

**Step 3: To calculate the median first rewrite the data set in numerical order**

13, 13, 13, 13, 14, 14, 16, 18, 21

**Step 4: Identify the middle number**

- There are nine numbers in the list, so the middle one will be the  $(9 + 1) \div 2 = 10 \div 2 = 5$ th number:  
13, 13, 13, 13, **14**, 14, 16, 18, 21

So the median is **14**

[2 marks]

Note: The formula for the place to find the median is " $([\text{the number of data points}] + 1) \div 2$ ", but you don't have to use this formula. You can just count in from both ends of the list until you meet in the middle if you prefer, especially if the data set is small

**Step 5: To calculate the mode rewrite the data set in numerical order**

13, 13, 13, 13, 14, 14, 16, 18, 21

**Step 6: Identify the number that occurs most often in the list**

**13 occurs four times**

14 occurs twice

16 appears once

18 appears once

21 appears once

As it appears most frequently the mode number of valets sold is **13**

[2 marks]



Your notes

## Standard Deviation

- The standard deviation is a measure of the **spread of numbers** within a set of data
- It is a particularly useful **tool for planning** when managers have wide ranges of data and need to organise resources effectively



Your notes

### Worked example

*FreshBite* is a pre-packaged sandwich manufacturer which produces a range of products that are sold in cafés and refreshment stands in tourist attractions such as theme parks.

*Freshbite's* sales are highly variable - the business regularly suffers from high levels of wastage as a result of having large quantities of unsold stock. On several occasions it has also been unable to fulfill orders from customers as it has not produced enough units.

The business has recently employed a new operations manager who has suggested that calculating the standard deviation of sales would aid planning. He has requested the last month's sales data to allow him to calculate this.

Product	Last month's sales (\$)
A	110,000
B	27,000
C	12,000
D	54,000
E	7,000

Calculate the standard deviation of last months' sales for Freshbite.

[4 marks]

#### Step 1: Calculate the mean

$$110,000 + 27,000 + 12,000 + 54,000 + 6,000 = 210,000$$

$$210,000 \div 5 = 42,000$$

[1 mark]

#### Step 2: For each product, subtract the mean and square the result

Product	Last month's sales (\$000s)	Minus mean =	Squared = (000's)
A	110	68	4,624
B	27	-15	225
C	12	-30	900
D	54	12	144

E	7	-35	1,225
---	---	-----	-------

[1 mark]

**Step 3: Add up the squared differences and express in an expanded form**

$$4,624 + 225 + 900 + 144 + 1,225 = 7,118$$
$$= 7,118,000$$

[1 mark]

**Step 4: Find the square root to identify the standard deviation**

$$\sqrt{7,118,000} = \$ 2667.96$$

[1 mark]

Note - in this instance, a significant standard deviation from the mean informs Freshbite's managers that they need to carefully plan for significant variations in sales. This may include detailed market research as well as capital investment to reduce wastage (for example, further freezers)



Your notes

## Quartiles

- Quartiles are the values that **divide a list of numbers into quarters**
- Analysis of data using quartiles allows a business to see the **distribution and spread of data**
  - The **first quartile** is the lower 25% of a list of numbers
  - The **second quartile** is the lower 50% of a list of numbers
  - The **third quartile** is the lower 75% of a list of numbers
  - The **top quartile** is the highest 25% of a list of numbers
  - The **interquartile range** excludes outlying data in the top and bottom quartiles and examines the middle spread of data

### The Application of Quartile Ranges to a set of data

First Quartile							
Second Quartile							
Third Quartile							
						Top Quartile	
		Interquartile Range					
3	3.5	4.5	5	6	6.5	7.5	8



Your notes





Your notes

### Worked example

BestGrip is shoe manufacturing business that employs a team of sales managers who receive performance-related monthly bonuses on top of their monthly salaries.

Bonuses are awarded to those sales managers who achieve sales in the top quartile.

Sales data for the month of May are shown in the table below.

Salesperson	Volume of Sales
A	24,300
B	25,350
C	26,650
D	22,100
E	26,200
F	27,800
G	22,950
H	28,450
I	23,750
J	29,200
K	27,350
L	27,900

Identify the sales managers to be awarded a bonus in May.

[4 marks]

**Step 1: Put the list of data into order, from smallest to largest**

Salesperson	Volume of Sales
D	22,100
G	22,950
I	23,750
A	24,300
B	25,350
E	26,200



Your notes

C	26,650
K	27,350
F	27,800
L	27,900
H	28,450
J	29,200

[2 marks]

**Step 2: Divide the list into four equal parts:**

Salesperson	Volume of Sales	
D	22,100	Quartile 1
G	22,950	
I	23,750	
A	24,300	Quartile 2
B	25,350	
E	26,200	
C	26,650	Quartile 3
K	27,350	
F	27,800	
L	27,900	Quartile 4
H	28,450	
J	29,200	

[1 mark]

**Step 3: Identify the data within the top quartile**

- In this case, sales managers **L, H and J** will receive a performance-related bonus in May

[1 mark]



Your notes

## Graphs & Charts

- Analysing data contained in graphs/charts is an important business skills
- Data may be presented in a range of forms

### Bar charts

- **Bar charts** show data that are independent of each other such as sales per store

### Diagram of a Bar Chart

#### Consumer spending on home video entertainment (selected categories: USA, 2017)

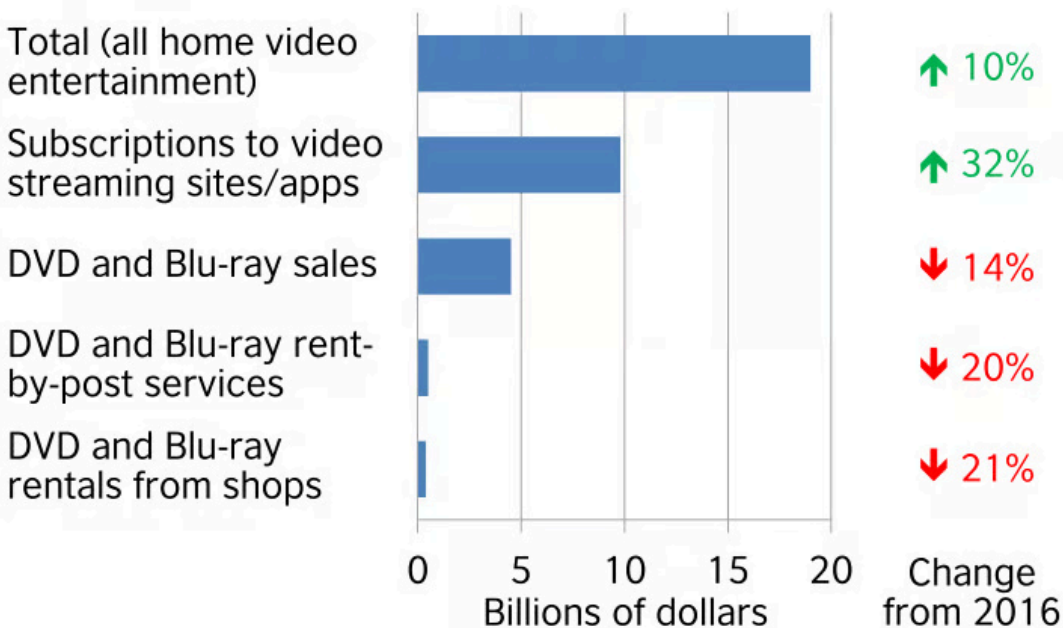

A bar chart showing sales revenue of a selection of home video entertainment formats in the USA in 2017

(Source: [British Council](#))

- The bar chart shows that the top two categories have increased since 2016
- The bottom three categories have all decreased with DVD/Blu-ray in store rentals falling the most

### Pie charts

- **Pie charts** show how a whole is divided into different element
  - E.g. The total business sales divided amongst different product types it sells
  - E.g. The market share different competitor have

### Diagram of a Pie Chart



Your notes

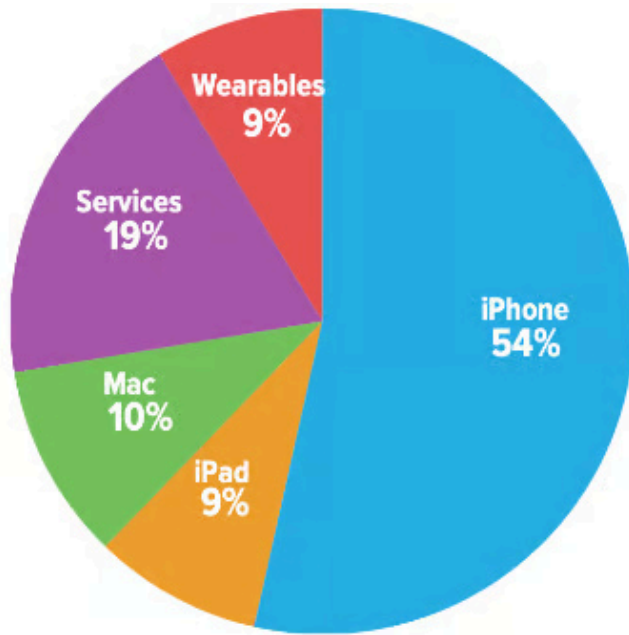

A pie chart showing Apple's quarterly revenue by category in April 2021

(Source: Six Colours)

- iPhones were the product which generated the highest value of sales revenue at 54%
- Mac sales represent one fifth of the value of iPhone sales

### Infographics

- Infographics are easy to understand visual representations of data

### Diagram of an Infographic



*An infographic used by Mars to communicate key business statistics*

(Source: [Mars](#))

- Mars has 140,000 associates
- Mars is still a privately owned family company
- Mars generated \$45B in net sales



Your notes



Your notes

 **Worked example**

Maggri Spice Ltd manufactures a range of hot curry pastes that are sold online and in specialist stores. In 2022 total sales were \$180,000, with sales for individual products shown in the pie chart below.

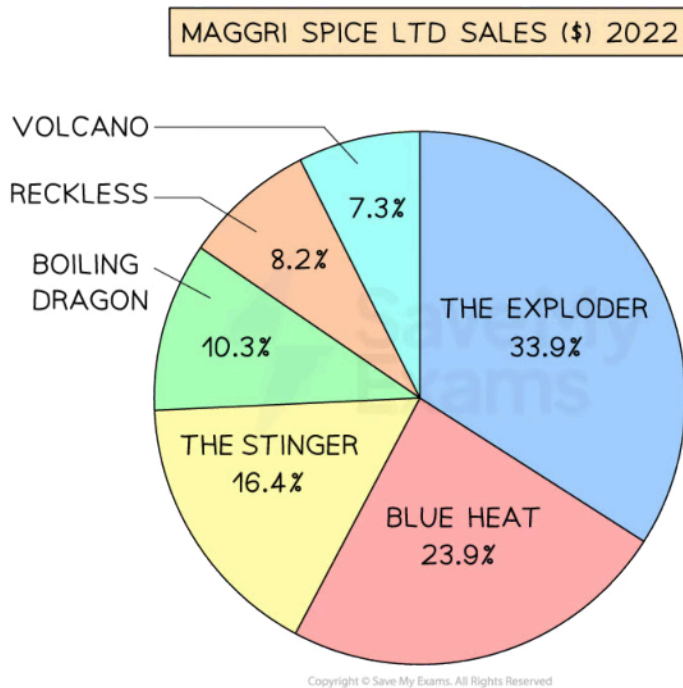

Calculate the value of sales of Blue Heat curry paste in 2022.

[2 marks]

**Step 1: Identify the percentage of total sales attributed to Blue Heat**

In this case **23.9%** of total sales can be attributed to Blue Heat

**Step 2: Convert the percentage to a decimal**

$$23.9\% = 0.239$$

[1 mark]

**Step 3 – Multiply total sales by the decimal**

$$\$180,000 \times 0.239 = \$43,020$$

Blue Heat curry paste achieved sales of \$43,020 in 2022

[1 mark]



Your notes

### Examiner Tip

You can make use of descriptive statistical techniques throughout both exam papers. They are particularly useful when **making comparisons** or **supporting chains of analysis** to lead to a **judgement**.

You do not have to wait to be told to use them in your work.

Interpreting data using these tools is a higher level approach to **application** and demonstrates that you are making optimum use of data presented in case study materials - this really does impress the examiner!



Your notes

## Circular Business Models

### Circular Business Models

- A circular business model is an approach to business designed to **minimise the consumption of scarce resources** and **reduce waste**
  - Circular business aims to maximise the use and value of resources
  - Materials and products are recycled, reused, or regenerated rather than being disposed of after use
  - A circular business model is also known as the **cradle-to-cradle** approach - further notes on this can be found [here](#)
  
- In a circular business model, products are designed with **durability, reparability, and recyclability** in mind
  - The focus is on creating products that can be easily disassembled and their components reused or recycled
  - This **promotes the use of renewable resources**, reduces dependence on finite resources and minimises a businesses environmental impact
  
- Adopting a circular business model requires a **shift in mindset** including
  - **Involving multiple stakeholders** including businesses, governments, consumers and investors
  - **Rethinking business processes**, product design, supply chains, and waste management practices

#### Key Principles of a Circular Business Model

Principle	Explanation
Design for longevity	▪ Products are designed to have a longer lifespan reducing the need for <b>frequent replacement</b>
Resource efficiency	▪ Resources are used efficiently throughout the product lifecycle, <b>minimising waste</b> and optimising material usage
Recycling & reuse	▪ Materials from products that have reached the end of their life cycle are recycled or reused to <b>create new products or components</b>
Product as a service	▪ Instead of selling products businesses provide them as services, such as leasing or renting, <b>encouraging product sharing</b> and extending their lifespan





Your notes

<b>Biomimicry</b>	<ul style="list-style-type: none"> <li>Nature-inspired design principles are used to create products and processes <b>that mimic natural systems</b> resulting in greater sustainability</li> </ul>
<b>Collaboration &amp; partnerships</b>	<ul style="list-style-type: none"> <li>Businesses collaborate with suppliers, customers and other stakeholders to <b>create closed-loop systems</b> and promote the exchange of materials and knowledge</li> </ul>

- Advantages** of a circular business model include
  - Reduced waste generation
  - Decreased reliance on finite natural resources
  - Cost savings through resource efficiency
  - Enhanced brand reputation
  - Increased resilience to resource scarcity and price volatility

## Patagonia as an Example of a Circular Business

- One example of a business with a circular business model is outdoor clothing company *Patagonia* which has implemented several initiatives to **promote sustainability** and **reduce waste**
- Its circular business model focuses on **extending the life of products, promoting repair and reuse, using recycled materials** and **encouraging responsible consumption**
  - The "Worn Wear" program encourages customers to **repair and reuse their clothing** instead of buying new items
    - The business offers free repairs for their products and also **sells used clothing through their online platform**, extending the lifespan of their products and reducing the overall demand for new clothing
  - Patagonia has made efforts to **use recycled and environmentally friendly materials** in their products
    - E.g. they have introduced a line of clothing made from recycled plastic bottles and recycled polyester and use organic cotton to minimise the environmental impact of their manufacturing processes
  - Patagonia encourages responsible consumption by **actively discouraging customers from purchasing products they don't need**
    - E.g. advertising campaigns with slogans like "**Don't buy this jacket**" raise awareness about the environmental consequences of excessive consumption



Your notes

## Force Field Analysis

### Force Field Analysis

- Force field analysis involves managers identifying the driving and restraining forces that surround a strategic change decision
  - Once identified these forces can be analysed to determine whether a decision should go ahead

#### Driving forces

- Driving forces are factors that could justify that strategic change is needed
  - Internal driving forces** may include:
    - Outdated machinery or product lines
    - Declining team morale
    - The need to increase profitability
  - External driving forces** may include:
    - A volatile market
    - Disruptive technologies e.g. AI
    - Changing demographic trends

#### Restraining forces

- Restraining forces are factors that could prevent or limit change
  - Internal restraining forces** may include:
    - Fear of the unknown
    - The existing organisational structure
    - "That's not how things are done here" attitudes
  - External restraining forces** may include:
    - Existing commitments to partner organisations
    - Government legislation
    - Obligations towards customers

#### Weighting the forces

- Driving forces and restraining forces are weighted from 1 to 5 in terms of their relative importance
  - A value of 5 is most important and 1 least important

#### Diagram of a Force Field Analysis



Your notes

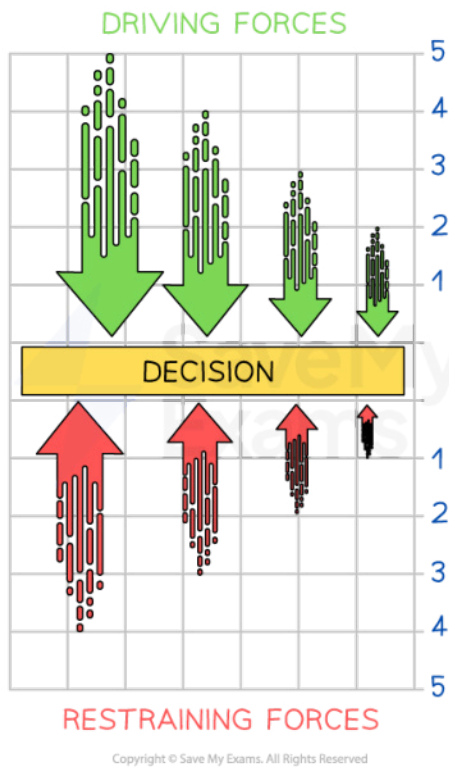

### Force Field Analysis for the Field Above

- **Four driving forces** justify a decision for change
  - Their weightings are 5, 4, 3 and 2
  - The total value of these driving forces is  $5 + 4 + 3 + 2 = 14$
  
- **Four restraining forces** prevent or limit change
  - Their weightings are 4, 3, 2 and 1
  - The total value of these restraining forces is  $4 + 3 + 2 + 1 = 10$
  
- The relative weight of driving forces is greater than the relative weight of restraining forces
- There is a **good chance that this decision would be successful**
- To maximise the chance of success **driving forces could be further strengthened** or **restraining forces weakened/eliminated**



Your notes

### Worked example

After several years of poor financial performance the owners of Lujosa Ltd are considering the relocation of their factory from Spain to Indonesia.

Department managers have provided feedback on the idea. They have identified the following driving and restraining forces.

Force	Description	Weighting
Driving	<ul style="list-style-type: none"> <li>Need to reduce production costs to increase profitability</li> </ul>	5
	<ul style="list-style-type: none"> <li>Outdated production machinery in Spanish factory affects volume and quality of output</li> </ul>	3
	<ul style="list-style-type: none"> <li>Difficulty of recruiting and retaining skilled employees in Spain</li> </ul>	1
Restraining	<ul style="list-style-type: none"> <li>Costs of relocation including construction and fitting of a brand new factory in Indonesia</li> </ul>	4
	<ul style="list-style-type: none"> <li>Employee resistance to job losses</li> </ul>	2
	<ul style="list-style-type: none"> <li>Disruption to production during the change period</li> </ul>	4

**(a) Use force field analysis to determine whether Lujosa's owners should go ahead with the decision [4]**

**Step 1: Construct the force field analysis**



Your notes

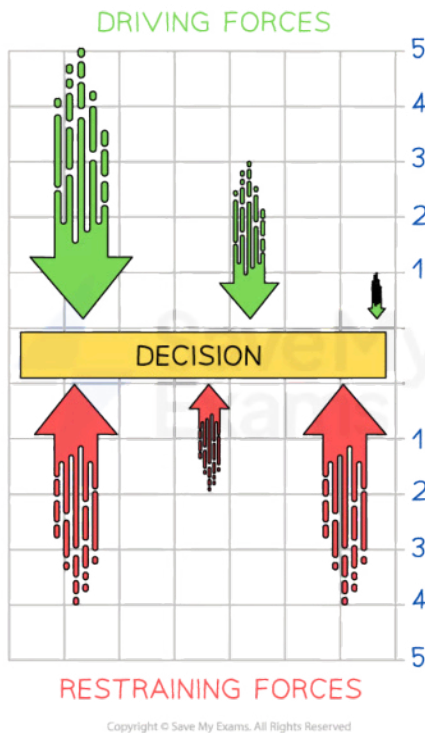

Copyright © Save My Exams. All Rights Reserved

[1]

**Step 2: Calculate the relative weight of driving forces**

$$5 + 3 + 1 = 9$$

[1]

**Step 3: Calculate the relative weight of restraining forces**

$$4 + 2 + 4 = 10$$

[1]

**Step 4: Compare the relative weights of driving and restraining forces**

- The relative weight of restraining forces (10) is greater than the relative weight of driving forces (9)
- There is **little chance that this decision would be successful and should be abandoned**

[1]

**(b) Identify two actions Lujosa's owners could take to allow the move to Indonesia to go ahead [2]**

- Relevant actions include
  - Outsource production during the relocation process
  - Research ways to reduce costs of building and fitting of the new factory

- Consult and engage with workers to reduce fears of redundancy

[2]



Your notes



Your notes

## Evaluating Force Field Analysis

- Force field analysis is a valuable technique for assessing the factors influencing a situation
- However it has limitations, particularly in situations where precision is required
- It is **most effective when used alongside other decision-making tools** to ensure a comprehensive understanding of the situation
- Force field analysis has a range of strengths and weaknesses

### Evaluating Force Field Analysis

Strengths	Weaknesses
<ul style="list-style-type: none"> <li><b>Simple and Visual</b> <ul style="list-style-type: none"> <li><b>Easily understood</b> by stakeholders</li> <li>Simple diagram makes it accessible</li> </ul> </li> </ul>	<ul style="list-style-type: none"> <li><b>Subjective</b> <ul style="list-style-type: none"> <li>Relies on perceptions/judgements of individuals or teams</li> <li>Can <b>lead to bias</b> in the analysis</li> </ul> </li> </ul>
<ul style="list-style-type: none"> <li><b>Comprehensive</b> <ul style="list-style-type: none"> <li>Considers both the <b>driving forces and restraining forces</b></li> <li>This helps in understanding the complexity of a situation</li> </ul> </li> </ul>	<ul style="list-style-type: none"> <li><b>Lacks Quantitative Data</b> <ul style="list-style-type: none"> <li>Challenging to assign specific weights or measures to the forces which <b>limits the precision of the analysis</b></li> </ul> </li> </ul>
<ul style="list-style-type: none"> <li><b>Identifies most critical factors</b> <ul style="list-style-type: none"> <li>Visualising/ranking helps <b>clarify which forces have the most significant impact</b> on the desired change</li> </ul> </li> </ul>	<ul style="list-style-type: none"> <li><b>Snapshot</b> <ul style="list-style-type: none"> <li>Does not account for how forces <b>might change over time</b></li> <li>This is crucial in dynamic/evolving business environments</li> </ul> </li> </ul>
<ul style="list-style-type: none"> <li><b>Assists Decision-Making</b> <ul style="list-style-type: none"> <li>Provides a <b>structured way to evaluate pros and cons</b> of a proposed change or decision</li> </ul> </li> </ul>	<ul style="list-style-type: none"> <li><b>Doesn't Provide Solutions</b> <ul style="list-style-type: none"> <li>It is a diagnostic tool not a prescriptive one</li> <li>Managers need to develop appropriate strategies</li> </ul> </li> </ul>
<ul style="list-style-type: none"> <li><b>Aids Communication</b></li> </ul>	<ul style="list-style-type: none"> <li><b>Limited in Complex Situations</b></li> </ul>

- |   |  |
|---|--|
| <ul style="list-style-type: none"><li>▪ Teams discuss and share their perspectives on the driving and restraining forces</li><li>▪ Leads to a shared understanding/better collaboration</li></ul> | <ul style="list-style-type: none"><li>▪ <b>Oversimplifies analysis</b> and fails to capture the intricacies of the problem</li></ul> |
|---|--|



Your notes





Your notes

## Gantt Charts

### Gantt Charts

- A Gantt chart is a project management tool used to **visualise and plan** tasks and their dependencies over time
  - It lists the **tasks to be performed** on the vertical axis
  - Time intervals** are shown on the horizontal axis
  - The width of the horizontal bars in the graph shows the **duration of each activity**
  - The **current schedule status** can be illustrated in the diagram

### Diagram of a Gantt Chart

## WEB APP DEVELOPMENT PROCESS GANTT CHART



An example of a simple Gantt chart used to plan the development and launch of a web app

- In this example the project comprises **seven distinct activities**
  - Market research**
    - Starts on 8th January and ends on March 17th
    - Duration of 40 days

- Currently 40% complete
  - **App design**
    - Starts on 16th February and ends on July 20th
    - Duration of 154 days
    - Currently 84% complete
  - **Development**
    - Starts on May 29th and ends on September 3rd
    - Duration of 98 days
    - Currently 51% complete
  - **Testing**
    - Starts on July 29th and ends on September 7th
    - Duration of 40 days
    - Currently 48% complete
  - **Launch**
    - Starts on September 8th and ends on November 18th
    - Duration of 72 days
    - Currently 0% complete
  - **Support**
    - Starts on October 1st and ends on December 31st
    - Duration of 92 days
    - Currently 0% complete
  - **Maintenance and documentation**
    - Starts on June 13th and ends on December 11th
    - Duration of 152 days
    - Currently 72% complete
- 
- Gantt charts can also show who is responsible for an activity and any **dependencies** between activities



Your notes



Your notes

## LAMBERT CONSTRUCTION LTD

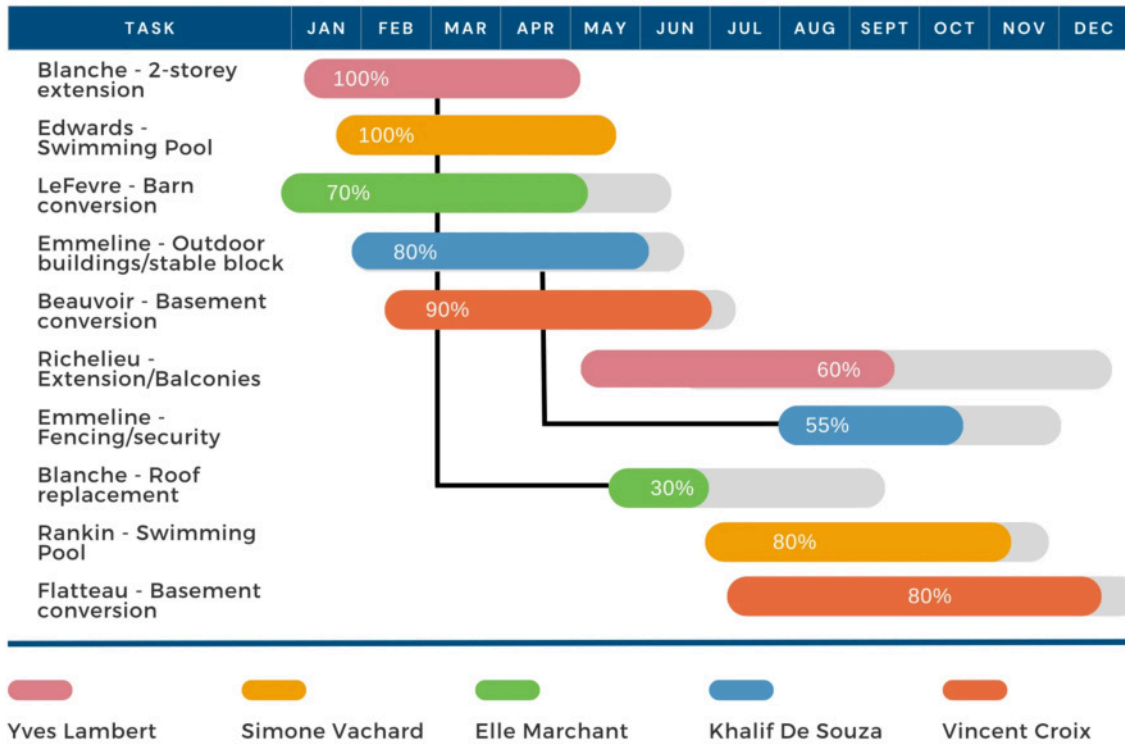

A Gantt chart used to plan construction tasks for the year

- This example shows the **tasks** the business has been employed to complete over the year
- **Project managers for each task** are identified in the key
- **Dependent tasks** are identified by lines



Your notes

### Worked example

Neuheit Möbel is planning to relocate its head office. The operations manager has identified the tasks required to complete the relocation efficiently

Relocation is expected to commence on 1st July. It is hoped that it will be complete by 1st December

Task	Preceded by	Duration (weeks)
A	-	3
B	-	4
C	A	3
D	B	6
E	C/D	2
F	E	1
G	F	4
H	F	2
I	H	3

(a) Construct a Gantt chart using the data in the table [4]



[4]



Your notes

**(b) Identify the total number of weeks the head office relocation is expected to take [2]**

4 months x 4 weeks = 16 weeks

1 month x 2 weeks = 2 weeks [1]

16 weeks + 2 weeks = 18 weeks [1]

**(c) State whether the head office relocation will be complete by 1st December [1]**

Yes - the relocation will be complete by mid-November

## Evaluating Gantt Charts

- The effectiveness of Gantt charts as a project management tool depends on the specific project's characteristics
  - They are useful for projects with **well-defined timelines** and **dependencies**
  - They are less useful for **highly dynamic** or **complex projects**
- Gantt charts should be **combined with other project management tools** to maximise their usefulness

### An Evaluation of Gantt Charts in Project Planning

Strengths	Weaknesses
<ul style="list-style-type: none"> <li>▪ <b>Visual clarity</b> <ul style="list-style-type: none"> <li>▪ Easy for team members /stakeholders to understand the schedule at a glance</li> <li>▪ Easy to compare planned timelines with actual progress</li> </ul> </li> </ul>	<ul style="list-style-type: none"> <li>▪ <b>Complex &amp; time-consuming</b> <ul style="list-style-type: none"> <li>▪ Projects with many tasks and dependencies are difficult to schedule in a Gantt chart</li> <li>▪ Creating/maintaining Gantt charts uses management time particularly when changes are frequent</li> </ul> </li> </ul>
<ul style="list-style-type: none"> <li>▪ <b>Resource allocation &amp; communication</b> <ul style="list-style-type: none"> <li>▪ Can show when specific resources are needed for various tasks</li> <li>▪ Can share project timelines and plans with team members and increase transparency</li> </ul> </li> </ul>	<ul style="list-style-type: none"> <li>▪ <b>Inflexibility</b> <ul style="list-style-type: none"> <li>▪ Adjusting the schedule is difficult when many tasks are dependent on each other</li> <li>▪ Focus on the time taken may not provide a clear view of the level of demand of different tasks</li> </ul> </li> </ul>



Your notes

## Hofstede's Cultural Dimensions

### Hofstede's Cultural Dimensions

- Hofstede's model is a way of **understanding the culture of a country** based on its cultural values
  - It can help organisations **improve communication** and **cooperation** between people from different cultures
  - It provides a **framework** for understanding **how cultural differences can affect business dealings**
- The Hofstede organisation **uses surveys to generate scores** for each country using six different variables
  - These scores are then accessible to businesses to use in their decision-making process
  - The tool is most useful when the scores of different countries are **compared with each other**

### Diagram of Country Rankings Using Hofstede's Model

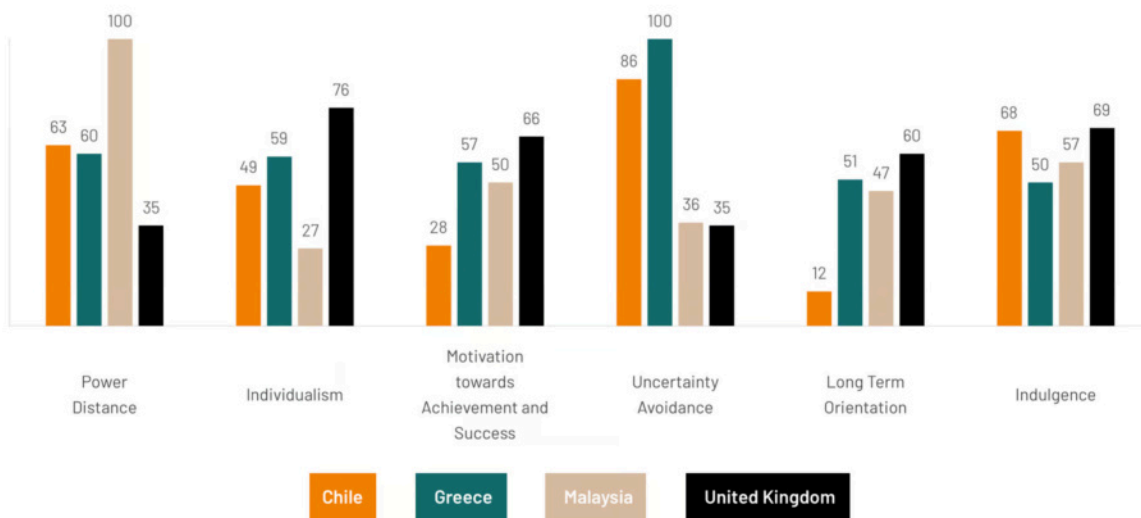

#### *A comparison of cultures using Hofstede's model*

(Source: [Country Comparison Tool](#))

- Six different dimensions are used for comparison
- Each dimension is **expressed on a scale** that runs from **0 to 100**
  - If a score is under 50, the culture scores relatively low on that scale
  - If any score is over 50, the culture scores high on that scale

#### An Explanation of Hofstede's Six Cultural Dimensions



Your notes

Dimension	Explanation	Examples
<p><b>Power Distance</b></p>	<ul style="list-style-type: none"> <li>Power Distance is defined as the extent to which the less powerful members of institutions and organisations within a country expect and accept that power is distributed unequally</li> </ul>	<ul style="list-style-type: none"> <li>Low-scoring countries include Australia, the USA and Finland</li> <li>High-scoring countries include Mexico, Russia and Philippines</li> </ul>
<p><b>Individualism</b></p>	<ul style="list-style-type: none"> <li>The degree of interdependence a society maintains among its members                             <ul style="list-style-type: none"> <li>In <b>Individualist societies</b> people are supposed to look after themselves and their direct family only</li> <li>In <b>Collectivist societies</b> people belong to 'in groups' that take care of them in exchange for loyalty</li> </ul> </li> </ul>	<ul style="list-style-type: none"> <li>Low-scoring (collectivist) countries include China, Pakistan and Malaysia</li> <li>High-scoring (individualist) countries include the UK, South Africa and Italy</li> </ul>
<p><b>Motivation Towards Success</b></p>	<ul style="list-style-type: none"> <li>A high score (<b>Decisive</b>) on this dimension indicates that the society will be driven by competition, achievement and success</li> <li>A low score (<b>Consensus-oriented</b>) on the dimension means that the dominant values in society are caring for others and quality of life</li> </ul>	<ul style="list-style-type: none"> <li>Low-scoring countries include Norway, Portugal and Chile</li> <li>High-scoring countries include Germany, Japan and Australia</li> </ul>
<p><b>Uncertainty Avoidance</b></p>	<ul style="list-style-type: none"> <li>The extent to which a society tolerates or avoids uncertainty and ambiguity                             <ul style="list-style-type: none"> <li>The extent to people feel threatened by unknown situations and have created beliefs and institutions that try to avoid these are reflected in this score</li> </ul> </li> </ul>	<ul style="list-style-type: none"> <li>Low-scoring (tolerant) countries include Sweden, Tunisia and Namibia</li> <li>High-scoring (avoiding) countries include Spain, Turkey and Ecuador</li> </ul>
<p><b>Long-term Orientation</b></p>	<ul style="list-style-type: none"> <li>The extent to which society has to maintain some links with its own past while dealing with the challenges of the present and future                             <ul style="list-style-type: none"> <li>Low score countries prefer to maintain traditions and norms</li> </ul> </li> </ul>	<ul style="list-style-type: none"> <li>Low-scoring (long-term) countries include Ukraine, Latvia and Norway</li> <li>High-scoring (short-term) countries include Venezuela, Morocco and Saudi Arabia</li> </ul>

	<ul style="list-style-type: none"><li>Those with high scores encourage modern education as a way to prepare for the future</li></ul>	
<b>Indulgence</b>	<ul style="list-style-type: none"><li>The extent to which people try to control their desires and impulses based on the way they were raised</li><li>These are defined as <b>restrained</b> and <b>indulgent</b> societies</li></ul>	<ul style="list-style-type: none"><li>Low-scoring (restrained) countries include Poland, Indonesia and Estonia</li><li>High-scoring (indulgent) countries include Argentina, Ireland and New Zealand</li></ul>



Your notes





Your notes

## Using Hofstede's Model

- Hofstede's model can help businesses to **make informed decisions** and **develop appropriate strategies** when **operating in international markets**
- In particular the model can help a business to
  - Understand **cultural differences** across locations in which it operates
  - Focus its **market research** and **product development**
  - Tailor its **promotional activities**
  - Structure **HR, training and team management** appropriately
  - Determine suitable international **expansion strategies**
  - Consider approaches to **corporate social responsibility**

## Applying Hofstede's Cultural Dimensions to AirBnB's International Operations

- Launched in 2008, **Airbnb** is a US-based company operating an **online marketplace** for private hosts to promote short- and long-term homestays and experiences
  - The company acts as a **broker** and charges a commission from each booking
  - It operates in around **220 countries** around the world and generated its first profit in 2022

### AirBnB Hofstede Analysis

Cultural Dimension	Explanation	Application to AirBnB
Power Distance	<ul style="list-style-type: none"> <li>▪ In <b>low power countries</b> AirBnB considers the needs of a <b>broad range of people</b> whose focus is on elements of a product that <b>make their tasks easier</b></li> <li>▪ In <b>high power countries</b> AirBnB focuses on meeting the <b>needs of key decision makers</b> by emphasising their products benefit the whole family or company and how products can <b>make their leadership a success</b></li> </ul>	<ul style="list-style-type: none"> <li>▪ In <b>Australia</b> AirBnB's promotional activities focus on the <b>convenience</b> and <b>ease of booking/paying for stays</b> in properties</li> <li>▪ In <b>Mexico</b> promotional activity focuses on <b>financial returns</b> for property owners and possible <b>cost savings</b> for users of the platform</li> </ul>
Individualism	<ul style="list-style-type: none"> <li>▪ In countries with <b>high individualism</b> AirBnB's recruitment and selection processes emphasise the personal success that recruits could achieve by working within the business</li> </ul>	<ul style="list-style-type: none"> <li>▪ Advertisements for senior roles in AirBnB's <b>London</b> office emphasise the performance-related pay and bonus rewards the business offers</li> </ul>



Your notes

	<ul style="list-style-type: none"> <li>In <b>low individualism</b> countries AirBnB emphasises the social and collective aspects of working for the business</li> </ul>	<ul style="list-style-type: none"> <li>Host recruitment policies in <b>Malaysia</b> emphasise the wealth that groups of AirBnB properties in areas that lack hotels can generate for communities</li> </ul>
<b>Motivation Towards Success</b>	<ul style="list-style-type: none"> <li>In <b>decisive</b> societies AirBnB has set challenging targets for growth into new markets</li> <li>AirBnB's approach in <b>consensus-oriented</b> societies' is less target-driven, emphasising quality and the minimisation of negative impacts of short-term lets on populations</li> </ul>	<ul style="list-style-type: none"> <li>In the <b>US</b> AirBnB has established regional sales headquarters in major cities which operate independently and compete to attract large volumes of hosts and bookings</li> <li>In <b>Norway</b> AirBnB has developed its <i>Airbnb Plus</i> and <i>Beyond by Airbnb</i> schemes which focus on encouraging hosts to offer high-quality, premium priced properties</li> </ul>
<b>Uncertainty Avoidance</b>	<ul style="list-style-type: none"> <li>In countries with <b>high tolerance to uncertainty</b> AirBnB market tests many of its new services and encourage hosts to make more unusual properties available to rent</li> <li>In countries with <b>low tolerance to uncertainty</b> the range of properties available for rent is relative narrow and standardised</li> </ul>	<ul style="list-style-type: none"> <li>In <b>Sweden</b> AirBnB lettings include a former military hut, a lighthouse and several treehouses!</li> <li>In <b>Spain</b> all AirBnB hosts are encouraged to provide standard facilities in their properties such as a private entrance</li> </ul>
<b>Long-term Orientation</b>	<ul style="list-style-type: none"> <li>In <b>long-term outlook</b> countries AirBnB may emphasise its commitment to social responsibility by encouraging its hosts to adopt environmentally friendly practices in its properties</li> <li>In <b>short-term outlook</b> countries AirBnB's focus is more profit- or sales-focused</li> </ul>	<ul style="list-style-type: none"> <li>In <b>Latvia</b> AirBnB hosts receive extensive guidance and practical support on achieving carbon neutral status for their rental properties</li> <li>In <b>Chile</b> the availability of low-cost housing has significantly worsened since AirBnB's successful marketing campaigns to recruit hosts in major cities</li> </ul>
<b>Indulgence</b>		



Your notes

- |  |  |  |
|--|--|--|
|  | <ul style="list-style-type: none"> <li>In <b>restrained</b> societies products may be designed to appeal on the basis of logic, common sense or good value</li> <li>In <b>indulgent</b> societies AirBnB encourages its hosts to offer aspirational properties that appeal to people's desire to 'treat themselves'</li> </ul> | <ul style="list-style-type: none"> <li>Polish citizens take fewer holidays than many European counterparts - AirBnB's properties in Poland tend to be large and are aimed at longer family stays</li> <li>In <b>New Zealand</b> AirBnB has a growing selection of very short-term, super-luxury 'experience' properties</li> </ul> |
|--|--|--|

## Evaluating Hofstede's Model

- Whilst Hofstede's model can **help businesses make better decisions** it has been criticised as **outdated** and for **leading to** confirmation bias

### An Evaluation of Hofstede's Cultural Dimensions Model

Strengths	Weaknesses
<ul style="list-style-type: none"> <li><b>Structured framework makes comparison easy</b> <ul style="list-style-type: none"> <li>It is a structured framework for understanding and comparing cultures which improves awareness</li> </ul> </li> </ul>	<ul style="list-style-type: none"> <li><b>Generalisation</b> <ul style="list-style-type: none"> <li>Culture is complex and dynamic - reducing it to a set of dimensions can reinforce stereotypes</li> </ul> </li> </ul>
<ul style="list-style-type: none"> <li><b>Credible model</b> <ul style="list-style-type: none"> <li>Research into the model involved thousands of respondents from different countries</li> </ul> </li> </ul>	<ul style="list-style-type: none"> <li><b>Lack of nuance</b> <ul style="list-style-type: none"> <li>It treats a country as if all its people share the same characteristics - this is often not the case especially in very large countries such as the US</li> </ul> </li> </ul>
<ul style="list-style-type: none"> <li><b>Clear and simple</b> <ul style="list-style-type: none"> <li>The small number of dimensions makes the model accessible and easy to apply</li> </ul> </li> </ul>	<ul style="list-style-type: none"> <li><b>Ethnocentrism</b> <ul style="list-style-type: none"> <li>Hofstede's model is rooted in Western cultural values so may not capture the true nature of non-Western cultures</li> </ul> </li> </ul>
<ul style="list-style-type: none"> <li><b>Practical application</b> <ul style="list-style-type: none"> <li>Understanding cultural dimensions can help with adapting strategies and communication so they are effective in different countries</li> </ul> </li> </ul>	<ul style="list-style-type: none"> <li><b>Changes over time</b> <ul style="list-style-type: none"> <li>Cultures shift due to various factors, including globalisation and generational shifts</li> </ul> </li> </ul>



Your notes

## Porter's Generic Strategies

### Porter's Generic Strategies

- Porter's Generic Matrix identifies a range of strategies a business can utilise to increase their success
- The matrix considers two factors
  - Its **source of competitive advantage** (cost or differentiation)
  - The **scope** of the market in which it operates (mass or niche)
- Porter's generic strategies provide a **clear framework** for businesses to determine the most appropriate strategy to succeed in the mass market or within a smaller niche market
- It emphasises the importance of developing distinctive capabilities and avoid being 'stuck in the middle'

#### A Diagram to show Porters Generic Matrix

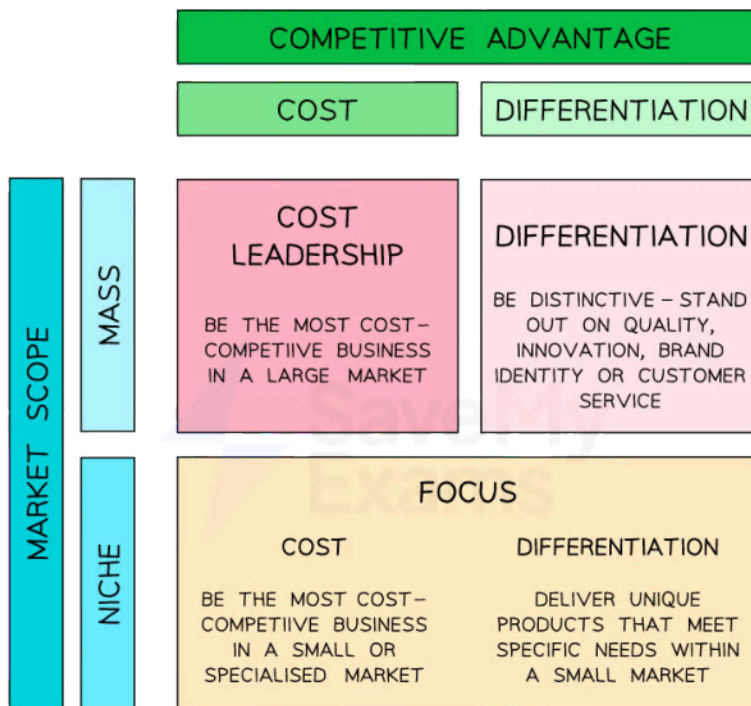

Copyright © Save My Exams. All Rights Reserved

*Porter's generic matrix identifies suitable strategies for mass and niche markets*

- The model encourages businesses to make strategic choices that are **difficult for competitors to copy**

- Pursuing one strategy forces the business to **make explicit choices** about its direction and concentrate on it
- The model does not offer guidance to businesses on **specific tactics** or **implementation**
- The model often overlooks **external factors** such as technological change, economic conditions and changes in laws which could impact competitive position

### Stuck in the Middle

- Porter argued that failing to adopt one of the strategies risks a business being '**stuck in the middle**'
  - This means it is **unable to compete successfully** with rivals in the market because each strategy is different
  - A business should **select its strategy and concentrate its resources on pursuing it** rather than simply responding to its competitors actions
- Pursuing a **mixture** of strategies is also **not feasible in the long term**
  - For example, cost leadership and differentiation are unlikely to be financially compatible
    - Low prices combined with high quality can negatively affect consumer perceptions of the product



Your notes



Your notes

## Mass Market Strategies

### Cost Leadership

- Most suitable for businesses that have a **significant cost advantage** over rivals
  - **Cost leadership with parity** is where a business has lower costs than rivals but charges the same price
    - Examples include hotel chains such as *Premier Inn* and *Ibis Styles*
  - **Cost leadership with proximity** is where a business has lower costs and charges a lower price than rivals
    - Examples include budget airlines such as *Southwestern* and *Ryanair*

#### Evaluating the Cost Leadership Strategy

Advantages	Disadvantages
<ul style="list-style-type: none"> <li>▪ <b>Economies of Scale</b> <ul style="list-style-type: none"> <li>▪ Cost leadership involves large-scale production and lower unit cost</li> </ul> </li> <li>▪ <b>Competitive Pricing</b> <ul style="list-style-type: none"> <li>▪ Cost leaders can offer lower prices than their competitors which attracts more customers</li> </ul> </li> <li>▪ <b>Barriers to Entry</b> <ul style="list-style-type: none"> <li>▪ New rivals struggle to fund required capital investment</li> </ul> </li> </ul>	<ul style="list-style-type: none"> <li>▪ <b>Risky</b> <ul style="list-style-type: none"> <li>▪ May result in a price war if more than one business in a market pursues this strategy</li> </ul> </li> <li>▪ <b>Quality Concerns</b> <ul style="list-style-type: none"> <li>▪ Low costs/prices are often linked to poor quality</li> </ul> </li> </ul>

### Differentiation

- Businesses that cannot be the most competitive on cost should **make its products distinct** from those of rivals
- Successful differentiation allows a business to **charge a premium price** and achieve a **high profit margin**
- Examples of businesses that adopt a mass market differentiation strategy include **Coca Cola, Samsung and Volvo**
  - **Coca Cola's** trusted and well-known branding includes its logo, brand colours and characters such as the *Coca Cola truck*
  - **Samsung's** cutting-edge mobile phones have the most advanced package of technical features in the mass market
  - **Volvo's** focus on safety and build quality allows it to charge premium prices in the mass market

#### A Diagram to show ways to Achieve Differentiation



Your notes

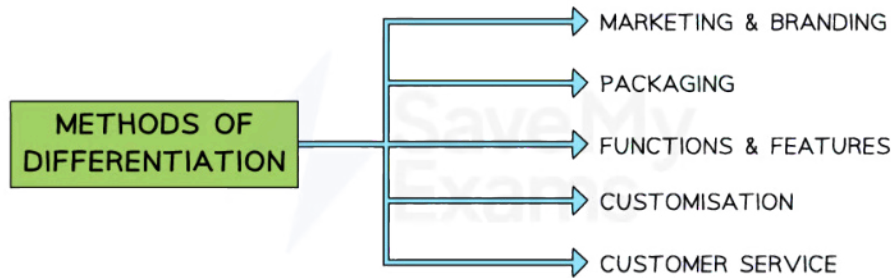

Copyright © Save My Exams. All Rights Reserved

***Businesses can achieve differentiation through branding, customer service, design features and quality***

### Evaluating a Differentiation Strategy

Advantages	Disadvantages
<ul style="list-style-type: none"> <li>▪ <b>Premium Pricing</b> <ul style="list-style-type: none"> <li>▪ Customers are willing to pay more for unique features, quality or brand image</li> </ul> </li> <li>▪ <b>Brand Loyalty</b> <ul style="list-style-type: none"> <li>▪ A strong brand image can lead to less price-sensitive loyal customers</li> </ul> </li> <li>▪ <b>Fewer Competitive Pressures</b> <ul style="list-style-type: none"> <li>▪ A differentiated product is difficult for rivals to imitate</li> </ul> </li> </ul>	<ul style="list-style-type: none"> <li>▪ <b>High Costs</b> <ul style="list-style-type: none"> <li>▪ Researching, developing and maintaining unique features requires significant budgets</li> </ul> </li> <li>▪ <b>Customer Preferences</b> <ul style="list-style-type: none"> <li>▪ Fashions, trends and customer preferences change over time</li> </ul> </li> </ul>



Your notes

## Niche Market Strategies

- Business that operates in a niche markets should adopt one of two **focus** strategies that closely meet the needs of its specific group of customers

### Cost focus strategy

- A **cost focus** involves being the **lowest cost competitor within the market niche**
  - Examples of businesses that adopt a cost focus strategy include **Carnival Cruise Line** and **Glasses Direct**
    - Carnival Cruises** sells cruises to locations including the Caribbean and Europe and is well-known for its eye-catching low fares that can be offered due to its fleet of smaller vessels that operate at full capacity
    - Glasses Direct** is an online retailer of spectacles that sells popular styles of lesser-known brands at very low prices as a result of its low overhead costs

### Differentiation focus strategy

- A **differentiation focus** involves offering **specialised products within the niche market**
  - Examples of businesses that adopt a differentiation focus strategy include Hotel Chocolat and Brompton Bicycle Retail Ltd
    - Hotel Chocolat** sells a range of **premium, fair-trade celebration confectionary** in its chain of beautifully-designed retail outlets
    - Brompton Bicycle Retail** sells **innovative products** such as the folding bicycle that closely meet the needs of its **wealthy commuter target market**

#### An Evaluation of Niche Market Strategies

Strengths	Weaknesses
<ul style="list-style-type: none"> <li>Focusing on a specific niche allows a business to <b>tailor its products</b> or services to a particular audience</li> <li>Can be <b>highly profitable</b> as <b>low competition</b> allows <b>high prices</b> to be charged</li> <li>Serving a niche market well can lead to <b>strong customer loyalty</b></li> </ul>	<ul style="list-style-type: none"> <li>Focusing on a small segment <b>limits sales potential</b></li> <li>If the niche <b>market shrinks or changes</b> the business may struggle to break even</li> <li>Larger competitors might enter the niche market and <b>outcompete</b> the focused business.</li> </ul>





Your notes

## Contribution

### An Introduction to Contribution

- Contribution is generated where the production process adds value
- This added value **contributes** to paying a businesses indirect costs (fixed costs)
- Contribution is the **difference between sales revenue and variable costs**
  - The amount left over **contributes** towards paying the fixed costs

- Contribution per unit** is calculated using the formula

$$\text{Selling price} - \text{Variable cost per unit}$$

- Total contribution** is calculated using the formula

$$\text{Contribution per unit} \times \text{Quantity of output}$$

#### Key uses of Contribution Analysis

Make or Buy Analysis	Contribution Costing	Absorption Costing
Determining whether to manufacture in-house or purchase from a third-party	A method of costing where only direct costs are allocated to products	A method of costing that allocates both direct and indirect costs to products



Your notes

## Make or Buy Analysis

- This process helps to decide if a business product should be **manufactured in-house** or **outsourced to a supplier**
  - If the cost to manufacture (CTM) is lower than the cost to buy (CTB) a business should manufacture the product in-house
  - If the CTB is lower than the CTM a business should outsource production to a third-party supplier

### Worked example

Renflux can manufacture processors for \$3.50 per unit. It can buy the same product from suppliers for \$4.30 per unit. It expects to sell 6,000 processors per month. Renflux has fixed costs of \$8,000 per month. [4 marks]

#### Step 1 - Identify the cost to make (CTM) and cost to buy (CTB)

$$\text{CTM} = \$3.50$$

$$\text{CTB} = \$4.30$$

#### Step 2 - Identify the quantity needed to be sold to cover fixed costs

$$\begin{aligned} & \frac{\text{Fixed costs}}{\text{CTB} - \text{CTM}} \\ &= \frac{\$8,000}{\$4.30 - \$3.50} \quad [2] \\ &= 10,000 \text{ units} \end{aligned}$$

#### Step 3 - Identify whether Renflux should make or buy

Fixed costs would only be fully covered if Renflux were to sell 10,000 units

In this case it expects to sell only 6,000 units

Renflux should therefore **make the processors in-house** [2]

- Make or buy analysis is a **quantitative decision-making method**
- **However, qualitative factors** should also be considered before the decision is made

### Qualitative Factors that can Affect Make or Buy Decisions



Your notes

Qualitative Factor	Explanation
1. Available capacity	<ul style="list-style-type: none"> <li>Whether the business has <b>sufficient staffing</b>, production facilities and storage to manufacture in-house</li> </ul>
2. Timeframe	<ul style="list-style-type: none"> <li>Whether the need for the product is <b>urgent</b></li> <li>Whether <b>production timescales</b> may be affected if products are not available</li> </ul>
3. Expertise	<ul style="list-style-type: none"> <li>Whether the business has the skills and <b>know-how to manufacture the product</b></li> <li>Whether the supplier has particular capabilities in manufacturing the product</li> </ul>
4. Reputation of suppliers	<ul style="list-style-type: none"> <li>Whether the <b>supplier delivers on-time</b> and within budget</li> <li>Whether specifications and desired quantities can be met</li> </ul>
5. External influences	<ul style="list-style-type: none"> <li>Whether exchange rates or <b>protectionist barriers affect price or delivery</b> of products from suppliers</li> </ul>



Your notes

## Contribution Costing

- Contribution costing is a method of costing where direct costs **are allocated to products or departments** of a business
  - It assumes that indirect costs must be paid during a particular time period regardless of the level of production for each product
  - Each profitable product contributes towards paying these overheads

### Example: Lickety Split Desserts

- Lickety Split is a seaside ice cream café
- It sells a range of ice cream and sorbet-based desserts
- The table below shows a contribution analysis for its top-selling products

Contribution Analysis for Lickety Split's Top-Selling Desserts

Product	Average unit price (\$)	Average variable cost (\$)	Unit contribution (\$)
Super Sundae	8.95	3.45	5.50
Nutty Surprise	9.95	4.25	5.70
Fruit Supreme	8.95	4.30	4.65
Ice Magic	8.95	2.25	6.70
ChocoLick	9.95	6.60	3.35

### Data Analysis

- Ice Magic is the **strongest product**
  - It earns the **highest contribution** (\$6.70) per product sold
- ChocoLick is the **weakest product**
  - It earns the **lowest contribution** (\$3.35) per product sold

- Twice as many ChocoLick as Ice Magic desserts would need to be sold to generate the **same level of contribution**
- All of Lickety Split's products are **profitable** because the **unit contribution is positive** in each case
- This positive contribution can **go towards paying Lickety Split's indirect costs** of operating the café



Your notes



Your notes

## Absorption Costing

- This method determines the most appropriate way to **apportion indirect costs to products or departments** of a business
  - Indirect costs need to be apportioned so that **all costs of production are fully covered**
  - Selling prices are then set accordingly
  - This ensures that the business is able, at the very least, to **break even**
- A simple way to apportion indirect costs is to **split them equally across products or departments**

### Example: Lickety Split Desserts

- Lickety Split is a seaside ice cream café
- It sells a range of ice cream and sorbet-based desserts
- The business has monthly indirect costs of \$7,500
  - Indirect costs are **split equally** across the five top-selling desserts
- The table below shows an absorption costing analysis for its top-selling products

**Absorption Costing Analysis for Lickety Split's Top-Selling Desserts**

Product	Average unit price (\$)	Average variable cost (\$)	Unit contribution (\$)	Indirect Cost Allocation (\$)	Break Even Point (desserts)
Super Sundae	8.95	3.45	5.50	1,500	273
Nutty Surprise	9.95	4.25	5.70	1,500	263
Fruit Supreme	8.95	4.30	4.65	1,500	323
Ice Magic	8.95	2.25	6.70	1,500	224
ChocoLick	9.95	6.60	3.35	1,500	448

### Data Analysis

- Indirect costs of \$1,500 are allocated to each product **equally**
- The break even point for each product can be calculated using the formula

$$\text{Break Even Point} = \frac{\text{Indirect Costs}}{\text{Unit Contribution}}$$

- As long as each product achieves its break even point Lickety Split's **indirect costs will be covered**

### Examiner Tip

**Other criteria** that may be used to allocate indirect costs including

- Floor area occupied by a product or department
- Sales volume or value
- Number of employees
- Output levels

Use the data provided to accurately allocate the indirect costs to the relevant product - and in the correct proportions



Your notes



Your notes

## Critical Path Analysis

### The Nature & Purpose of Critical Path Analysis

- Critical path analysis is a **project management tool** that uses **network analysis** to plan **complex** and **time-sensitive** projects
- It involves the construction of a **visual model** of the project that includes key elements
  - A list of all **activities** required to complete the project
  - The time (**duration**) that each activity will take to complete
  - How each project activity **depends** on others
- Critical Path Analysis shows
  - The order in which activities must be completed
  - The **longest path of project activities** to the completion of the project
  - The **earliest** and **latest** that each project activity can **start and finish** without delaying completion of the project as a whole
  - Activities within a project that can be carried out simultaneously are identified
  - The **critical project activities** which if delayed will cause the project as a whole to over-run
  - Those project **activities where some delay is acceptable** without delaying the project as a whole
  - The **shortest time possible** to complete the project
- It allows managers to identify the **relationships between the activities** involved and to work out the **most efficient way of completing the project**
  - **Resources** such as raw materials and components can be ordered or hired at precisely the right time they are needed
  - **Working capital** may be managed efficiently
  - Where **delays** occur managers can **identify the implications for the project's completion** and **redirect resources** if required





Your notes

## The Components of Network Analysis Diagrams

### A Network Analysis Diagram

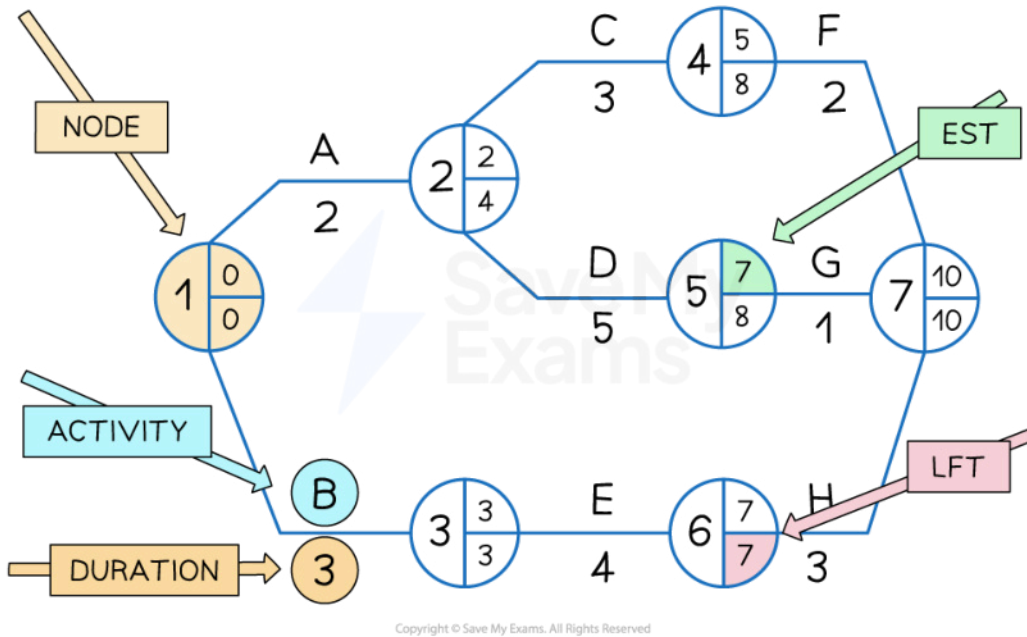

Copyright © Save My Exams. All Rights Reserved

*An example of a simple network diagram showing key elements*

- A network diagram must **always start and end on a single node**
- **Lines must not cross** and must **only be assigned to activities**

#### Explaining the Elements of a Network Diagram

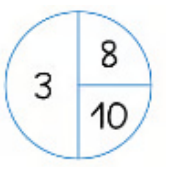
Element	Description
<b>Node</b> 	<ul style="list-style-type: none"> <li>▪ A node is a <b>circle</b> that represents a point in time where an activity is started or finished</li> <li>▪ <b>The node is split into three sections</b> <ul style="list-style-type: none"> <li>▪ The left half of the circle is the activity number</li> <li>▪ The top right section shows the earliest start time (EST) that an activity can begin based on the completion of the previous activity</li> <li>▪ The bottom right section shows the latest finish time (LFT) by which the previous activity must be completed</li> </ul> </li> </ul>
<b>Activities</b>	<ul style="list-style-type: none"> <li>▪ An activity is a process or task within a project that takes time</li> </ul>

	<ul style="list-style-type: none"><li>▪ Activities are shown on the network diagram as a <b>line which link nodes</b></li><li>▪ A description of the activity or a letter representing the activity is usually shown <b>above the line</b></li></ul>
<b>Duration</b>	<ul style="list-style-type: none"><li>▪ The duration is the length of time it takes to complete an activity</li><li>▪ The duration is shown as a <b>number of time units</b> such as hours or days <b>below the activity line</b></li></ul>



Your notes

## Calculating Earliest Start Times

- Working forwards from Node 1 it is possible to calculate the **Earliest Start Time** for each activity by **adding the duration of each task**



Your notes

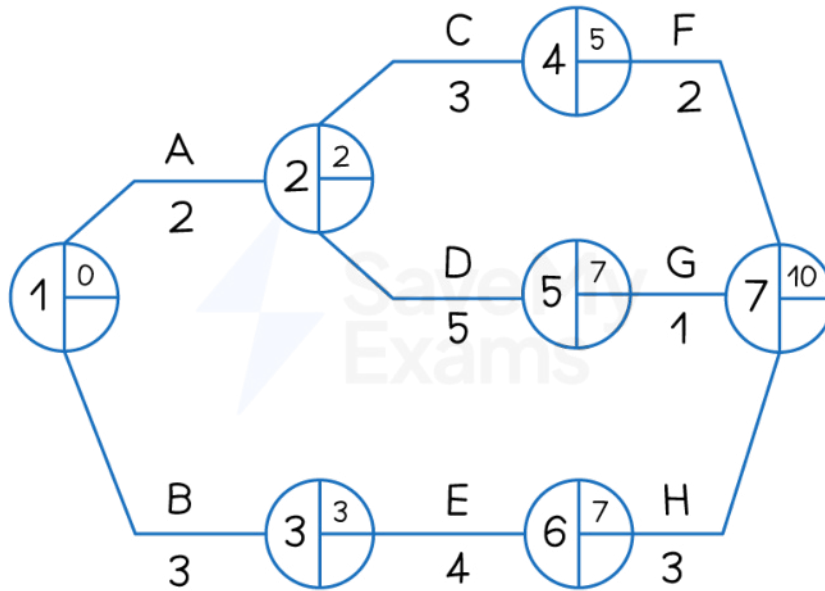

Copyright © Save My Exams. All Rights Reserved

**An example of a simple network diagram showing Earliest Start Times**

## Network Diagram Analysis

- The EST for each activity is placed in the **top right** of each node
  - Node 1 is the starting point of the project and where both Activity A and Activity B begin
  - Activity A and Activity B are independent processes
  - Activity A has a duration of 2 days and its earliest start time (EST) is 0 days
  - Activity B has a duration of 3 days and its EST is also 0 days
  - Activity C and Activity D both begin at Node 2 and are dependent upon the completion of Activity A but are independent from each other
    - Activity C has a duration of 3 days and its EST is 2 days
    - Activity D has a duration of 5 days and its EST is also 2 days
  - Activity E begins at Node 3
    - Activity E has a duration of 4 days and its EST is 3 days
  - Activity F begins at Node 4
    - Activity F has a duration of 2 days and its EST is 5 days
  - Activity G begins at Node 5
    - Activity G has a duration of 1 day and its EST is 7 days
  - Activity H begins at Node 6

- Activity H has a duration of 3 days and its EST is 7 days
- Node 7 is the end point of the project



Your notes

## Calculating Latest Finish Times

- Working backwards from Node 7 it is now possible to calculate the Latest Finish Time (LFT) for each activity by **subtracting the duration of each task**



Your notes

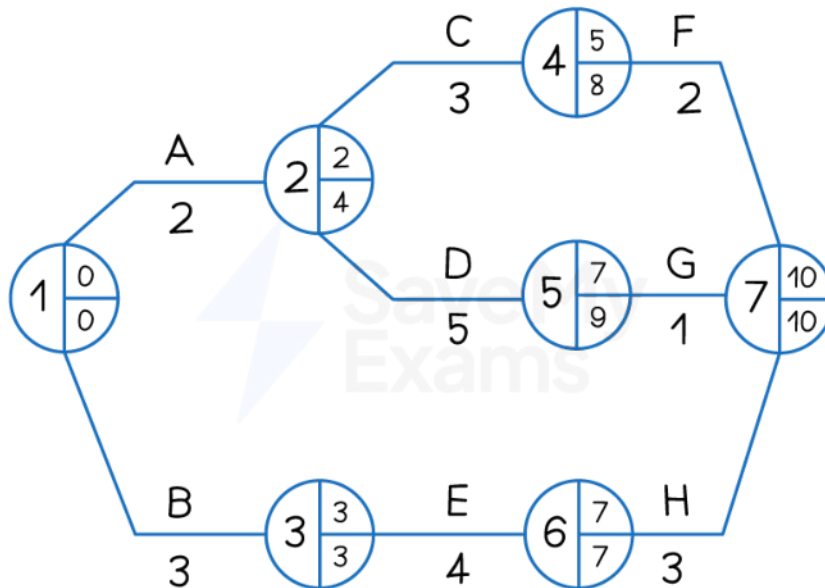

Copyright © Save My Exams. All Rights Reserved

*An example of a simple network diagram showing Earliest Start Times and Latest Finish Times*

## Network Diagram Analysis

- The LFT for each activity is placed in the **bottom right** of each node
  - Node 7 is the end point of the project which has a latest finish time of 10 days
  - Activity H has a duration of 3 days
    - The LFT in Node 6 is 7 days (10 days - 3 days)
  - Activity G has a duration of 1 day
    - The LFT in Node 5 is 9 days (10 days - 1 day)
  - Activity F has a duration of 2 days
    - The LFT in Node 4 is 8 days (10 days - 2 days)
  - Activity E has a duration of 4 days
    - The LFT in Node 3 is 3 days (7 days - 4 days)
  - Activity D has a duration of 5 days
    - The LFT in Node 2 is 4 days (9 days - 5 days)
  - Activity C has a duration of 3 days
    - The LFT in Node 3 is 4 days because Activity D is the more time-critical of the two activities that are dependent upon the completion of Activity A and so its LFT is recorded
  - Activity B has a duration of 3 days
    - The LFT in Node 1 is 0 days (3 days - 3 days)



Your notes

- Activity A has a duration of 2 days
  - The LFT in Node 1 is 0 days because Activity B is the more time-critical of the two starting activities and so its LFT is recorded
- The LFT in Node 1 is always 0

## Identifying the Critical Path

- The **critical path** highlights those **activities that determine the length of the whole project**
  - If any of these critical activities are delayed the **project as a whole will be delayed**
- The critical path follows the **nodes where the EST and LFT are equal**
  - In the diagram below nodes 1 3 6 and 7 have equal ESTs and LFTs
  - Activities that determine these nodes are B E and H
  - These activities are marked with two short lines
  - The critical path is therefore BEH

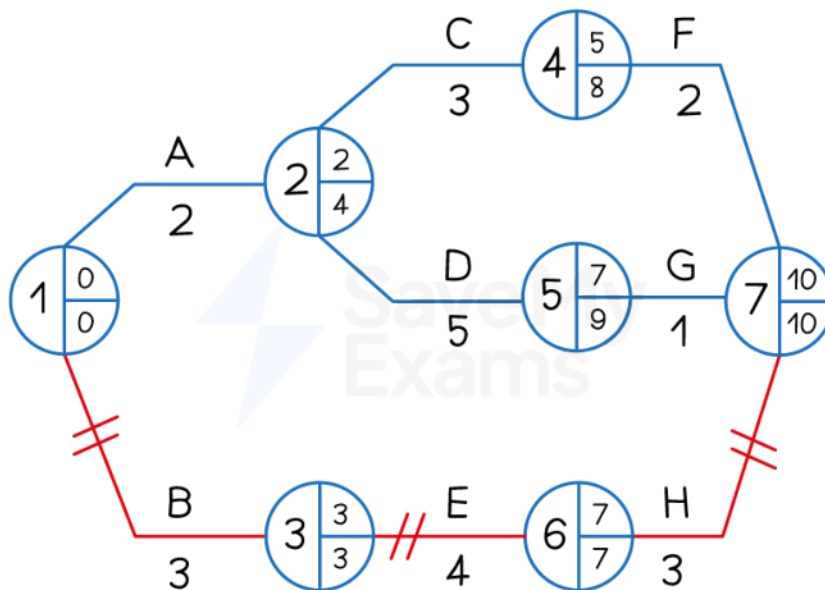

Copyright © Save My Exams. All Rights Reserved

*An example of a simple network diagram showing the critical path BEH*



Your notes

## Identifying and Calculating Float Time

- Float time exists where there is a **difference between the Earliest Start Time (EST) and the Latest Finish Time (LFT)**
- Where float time is identified managers may
  - Transfer resources** such as staff or machinery to more critical activities
  - Allow extra time** to complete tasks to improve quality or allow for creativity

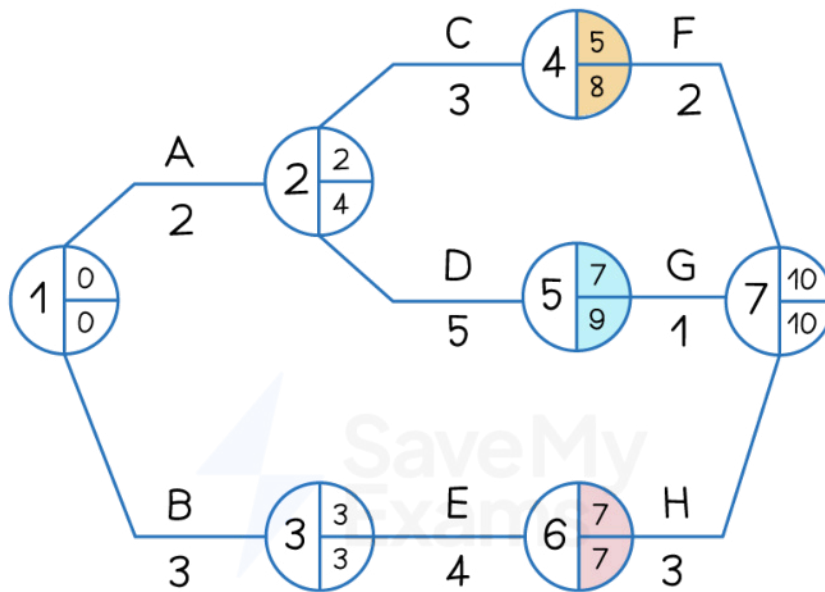

AT NODE 4 THERE IS A DIFFERENCE OF 3 DAYS (8 DAYS – 5 DAYS)

AT NODE 5 THERE IS A DIFFERENCE OF 2 DAYS (9 DAYS – 7 DAYS)

AT NODE 6 THERE IS NO FLOAT TIME. SPARE RESOURCES MAY BE USED TO SUPPORT COMPLETION OF CRITICAL ACTIVITY H

Copyright © Save My Exams. All Rights Reserved

*An example of a simple network diagram showing float nodes (4 and 5) and a critical node (6)*

## Float Time Analysis

- The **total float** refers specifically to spare time that is available so that the **overall project completion is not delayed**
- The **total float** for a specific activity is calculated by

$$\text{LFT for the activity} - \text{Duration of the activity} - \text{EST for the activity}$$



Your notes

- Using the diagram above the following **total float times** can be calculated for Activities A to H

Activity	LFT	- Duration	- EST	= Total Float
A	4	2	0	2
B	3	3	0	0
C	8	3	2	3
D	9	5	2	2
E	7	4	3	0
F	10	2	5	3
G	10	1	7	2
H	10	3	7	0

- The critical activities B E and H each have a total float of 0 days





Your notes

 **Worked example**

The network diagram below shows the activities involved in a new promotional campaign for a small fashion accessories business as well as the time (in weeks) it is expected that each activity will take to complete.

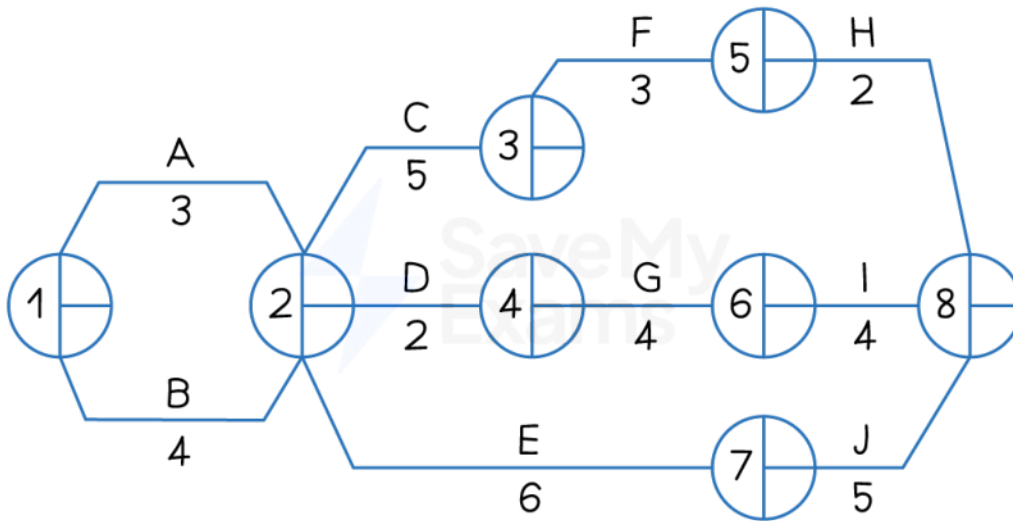

Copyright © Save My Exams. All Rights Reserved

**Calculate**

- a) The earliest start times and latest finish times for each node. (4 marks)
- b) The total float time for activity G. (3 marks)

**Step 1 - Calculate the Earliest Start Times (EST)**

Node 1 EST = 0

Node 2 EST =  $0 + 3 = 3$  **but**  $0 + 4 = 4$  so **4**

Node 3 EST =  $4 + 5 = 9$

Node 4 EST =  $4 + 2 = 6$

Node 5 EST =  $9 + 3 = 12$

Node 6 EST =  $6 + 4 = 10$

Node 7 EST =  $4 + 6 = 10$

Node 8 EST =  $12 + 2 = 14$  **but**  $10 + 4 = 14$  **and**  $10 + 5 = 15$  so **15**



Your notes

### Step 2 – Calculate the Latest Finish Times (LFT)

$$\text{Node 8} = 15$$

$$\text{Node 7} = 15 - 5 = 10$$

$$\text{Node 6} = 15 - 4 = 11$$

$$\text{Node 5} = 15 - 2 = 13$$

$$\text{Node 4} = 11 - 4 = 7$$

$$\text{Node 3} = 13 - 3 = 10$$

$$\text{Node 2} = 10 - 6 = 4$$

$$\text{Node 1} = 4 - 4 = 0$$

### Step 3 – Calculate the total float time for Activity G

$$\text{Total float} = \text{LFT for the activity} - \text{Duration of the activity} - \text{EST for the activity}$$

$$= 11 \text{ weeks} - 4 \text{ weeks} - 6 \text{ weeks}$$

$$= 1 \text{ week}$$

## Evaluating Critical Path Analysis

- Although Critical Path Analysis can be useful in project planning the method has some limitations

### Evaluating Critical Path Analysis as a Project Planning tool



Your notes

Limitations	Explanation
<ul style="list-style-type: none"> <li>Very lengthy or <b>complex projects involve a very large number of activities</b> that have numerous dependencies</li> </ul>	<ul style="list-style-type: none"> <li><b>Supervisors and specialist network planning software</b> may be required</li> </ul>
<ul style="list-style-type: none"> <li>Network analysis often <b>relies on estimates and forecasts</b></li> </ul>	<ul style="list-style-type: none"> <li>Significant research and good communication with suppliers is required to make <b>a network diagram really useful</b></li> </ul>
<ul style="list-style-type: none"> <li>Network analysis <b>does not guarantee the success</b> of a project</li> </ul>	<ul style="list-style-type: none"> <li><b>Project managers</b> will need to be <b>highly skilled</b> and will need <b>experience</b> of working with complicated plans</li> </ul>
<ul style="list-style-type: none"> <li>Resources may not prove to be as flexible as hoped when managers identify float periods</li> </ul>	<ul style="list-style-type: none"> <li>Employees may require <b>additional training</b> in order to transfer to critical tasks</li> <li>Machinery and other capital resources may need to be adapted or upgraded</li> </ul>



Your notes

## Simple Linear Regression

### Interpreting Scatter Graphs

- Scatter graphs allow businesses to compare **two variables** such as sales volume and advertising to establish if there is any **correlation** between them

#### Diagram of a Typical Scatter Graph

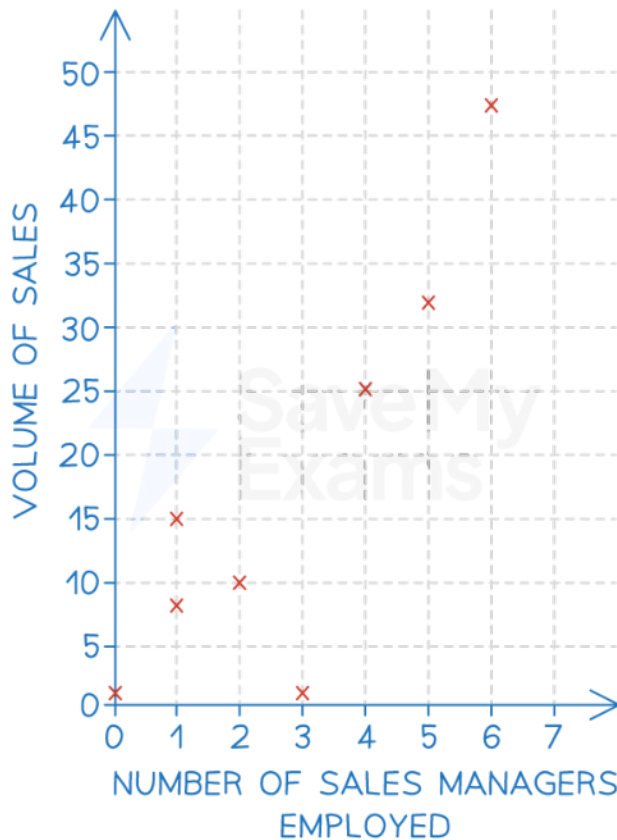

Copyright © Save My Exams. All Rights Reserved

*An example of a scatter graph showing the number of sales managers employed by a business and the volume of items sold*

### Types of correlation

- A correlation exists where there is a **relationship** or **connection** between two variables
- A **positive correlation** means **as one variable increases, so does the other variable**
  - A **line of best fit** that **slopes upwards** can be identified
- A **negative correlation** means **as one variable increases, the other variable decreases**
  - A **line of best fit** that **slopes downwards** can be identified



Your notes

- **No correlation** means there is **no connection** between the two variables
  - It is not possible to identify a **line of best fit**

### Diagram of Positive, Negative and No Correlation

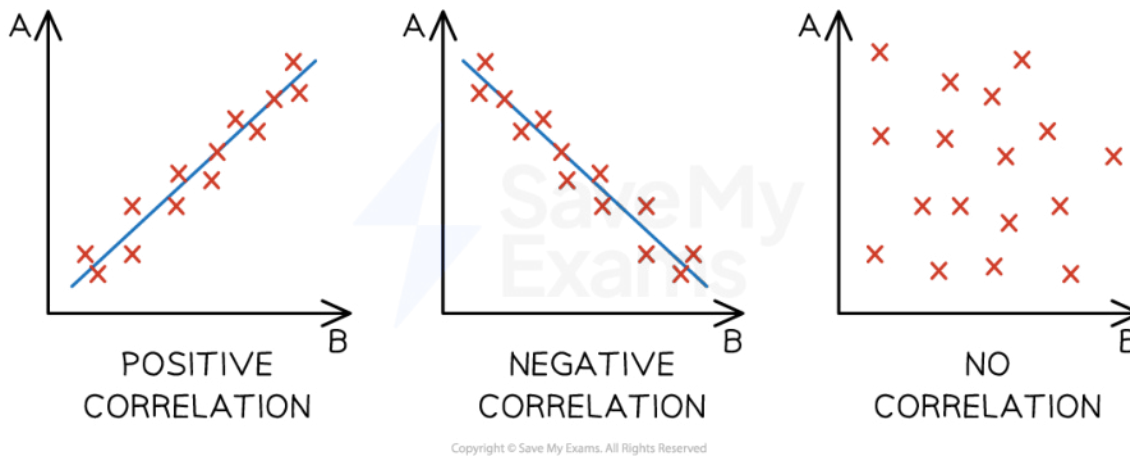

*The main types of correlation between two variables*

- Correlation does not always indicate a relationship or causation between two sets of variables so businesses need to **conduct research** to establish **whether a relationship exists** as well as the **strength of that relationship**

### Line of best fit

- A line of best fit (regression line) is a visualisation of a correlation between two sets of data
  - It is drawn roughly **through the middle of all of the points** on a scatter diagram
  - The line **may not go directly through** any data points - but should have the **same amount of data points above it as below it**
    - A **strong** (positive or negative) **correlation** exists when data points sit close to the line of best fit
    - The **further the distance** between the line of best fit and the spread of data points, **the weaker the** (positive or negative) **correlation**
- Where a **line of best fit can be identified** and when **causation** is determined, a business can **extrapolate** the data to make **predictions** around changes to either of the variables
  - E.g. extrapolation the line of best fit in the example below, the business could predict that **employing seven sales managers would be result in likely sales of 46 units**
- Extrapolation assumes that what has **happened in the past** will be the same as what will happen in the future

**Diagram of a line of best fit**



Your notes

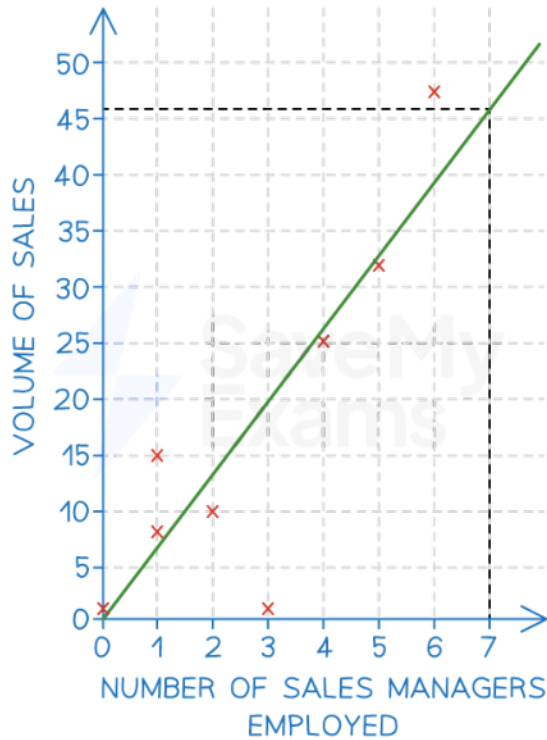

Copyright © Save My Exams. All Rights Reserved

**An example of a scatter graph with a line of best fit showing the number of sales managers employed by a business and the volume of items sold**

- Extrapolation works best when there is a **strong correlation** between the two data sets

 **Examiner Tip**

When drawing a line of best fit you should try to include as many data points above the line as below the line.

Watch out for outlying data - if there is more than one outlier above the line, adjust your line of best fit upwards. Similarly, if there is more than one outlier below the line, adjust your line of best fit downwards. Just one outlier should not influence your line of best fit.