

HL IB Chemistry



Your notes

The Periodic Table: Classification of Elements

Contents

- * The Periodic Table
- * Electron Configurations & the Periodic Table
- * Periodic Trends
- * Group 1 Metals with Water
- * Group 17 Elements with Halide Ions
- * Metallic & Non-Metallic Oxides
- * Oxidation States
- * Ionisation Energy Trends Across a Period (HL)
- * Characteristic Properties of Transition Elements (HL)
- * Variable Oxidation States in Transition Elements (HL)
- * Colour in Transition Metal Complexes (HL)



Your notes

The Periodic Table

The Periodic Table

- The **Periodic Table** is a list of all known elements arranged in order of **increasing atomic number**, from 1 to 118
- In addition, the elements are arranged so that atoms with the same number of shells are placed together, and atoms with similar electronic configurations in the outer shell are also placed together
 - This is achieved as follows:
 - The elements are arranged in rows and columns
 - Elements with **one** shell are placed in the **first row** (i.e. H and He)
 - Elements with **two** shells are placed in the **second row** (Li to Ne) and so on
- A row of elements thus arranged is called a **period**
 - The period number, **n**, is the outer energy level that is occupied by electrons
- In addition, the elements are aligned vertically (in columns) with other elements in different rows, if they share a similar outer-shell electronic configuration
 - The outer electrons are known as the **valence** electrons
 - A column of elements thus arranged is called a **group**

The Periodic Table



	ALKALI METALS																ALKALINE EARTH METALS										TRANSITION METALS										HALOGENS					NOBLE GASES											
1/I	1/I																2/II										3/III					4/IV				5/V	6/VI	7/VII	0/VIII														
2/II	Li																Be										B					C				N	O	F	Ne														
3/III	Na																Mg										Al					Si				P	S	Cl	Ar														
4/IV	K																Ca										Sc					Ti				V	Cr	Mn	Fe	Co	Ni	Cu	Zn	Ga	Ge	As	Se	Br	Kr				
5/V	Rb																Sr										Y					Zr				Nb	Mo	Tc	Ru	Rh	Pd	Ag	Cd	In	Sn	Sb	Te	I	Xe				
6/VI	Cs																Ba										La					Hf				Ta	W	Re	Os	Ir	Pt	Au	Hg	Tl	Pb	Bi	Po	At	Rn				
7/VII	Fr																Ra										Ac					Unq				Unp	Unh																

LANTHANIDE ELEMENTS																											
140	260	144	(147)	150	152	157	159	162	165	167	169	173	175	Ce	Pr	Nd	Pm	Sm	Eu	Gd	Tb	Dy	Ho	Er	Tm	Yb	Lu
58	59	60	61	62	63	64	65	66	67	68	69	70	71	CERMIUM	PRASEODYMIUM	NEODYMIUM	PROMETHIUM	SAMARIUM	EUROPIUM	GADOLINIUM	TERBIUM	DYSPROSIUM	HOLMIUM	ERBIUM	THULIUM	YTTERIUM	LUTETIUM
ACTINIDES ELEMENTS																											
(232)	(231)	(238)	(237)	(242)	(243)	(247)	(247)	(251)	(254)	(253)	(256)	(254)	(257)	Th	Pa	U	Np	Pu	Am	Cm	Bk	Cf	Es	Fm	Md	No	Lr
90	91	92	93	94	95	96	97	98	99	100	101	102	103	THORIUM	PROTACTINIUM	CAPRANIUM	NEPTUNIUM	PLUTONIUM	AMERICIUM	CURIUM	BERKELIUM	CALIFORNIUM	EINSTEINIUM	FERMIVIUM	MENDELEVIUM	NOBELIUM	LAWRENCIUM

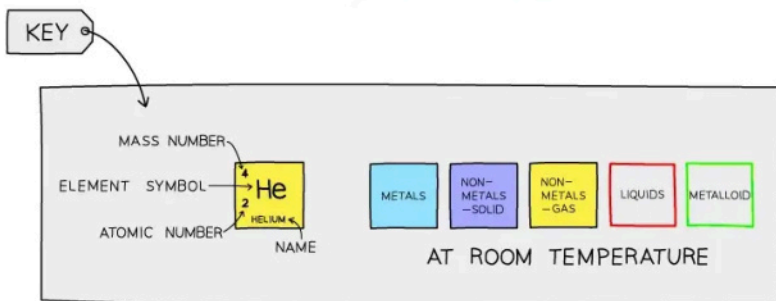

Copyright © Save My Exams. All Rights Reserved

The Periodic Table showing the groups and periods

- Since the electronic configurations of **H** and **He** are unusual, they do not fit comfortably into any group
- They are thus allocated a group based on similarities in physical and chemical properties with other members of the group
 - He** is placed in **Group 0** on this basis
 - Hydrogen does not behave like any other element and so is placed in a group of its own

Diagram to show the s, p and f blocks in the Periodic Table

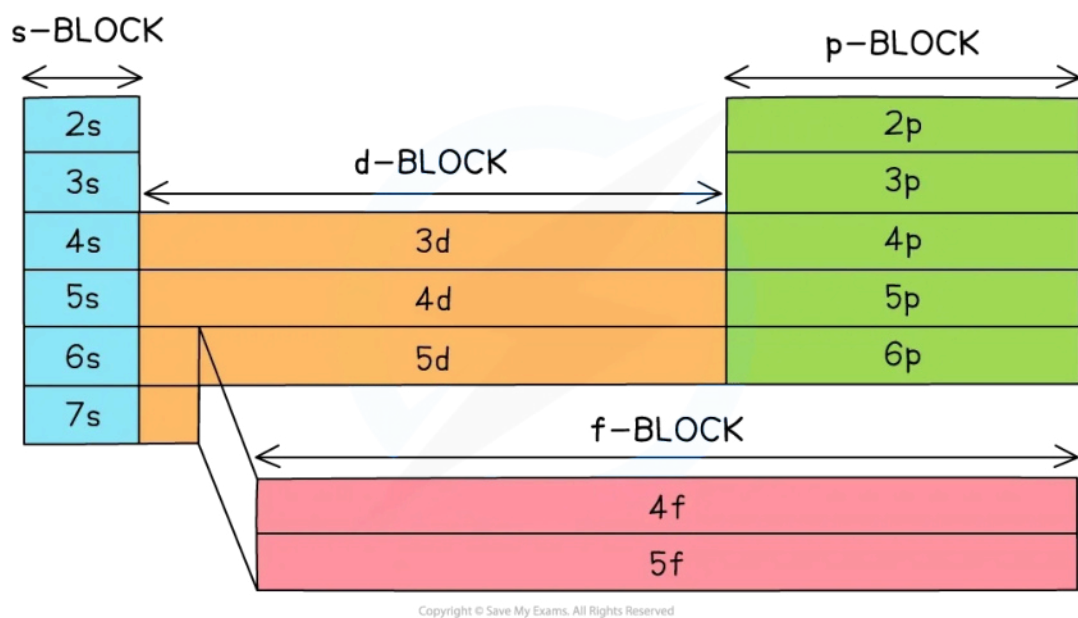

The blocks of the periodic table

- All elements belong to one of **four** main blocks: the s-block, the p-block, the d-block and the f-block
 - **s-block elements contain only s electrons in the outer shell**
 - **p-block elements contain at least one p-electron in the outer shell**
 - **The d-block elements are all those with at least one d-electron and at least one s-electron but no f or p electrons in the outer shell (up to 5d)**
 - **The f-block elements are all those with at least one f-electron and at least one s-electron but no d or p electrons in the outer shell**
- The physical and chemical properties of elements in the periodic table show clear patterns related to the position of each element in the table
 - Elements in the same group show similar properties, and properties change gradually as you go across a period
- As atomic number increases, the properties of the elements show trends which repeat themselves in each period of the periodic table
 - These trends are known as periodic trends and the study of these trends is known as **periodicity**



Your notes

Electron Configurations & the Periodic Table

Electron Configurations & the Periodic Table

- The electron configuration of any element can be deduced from its position in the periodic table
- It is like an 'address' that tells you exactly where an element is found
- Using the element germanium as an example to illustrate how it works:

Interpreting the electronic configuration

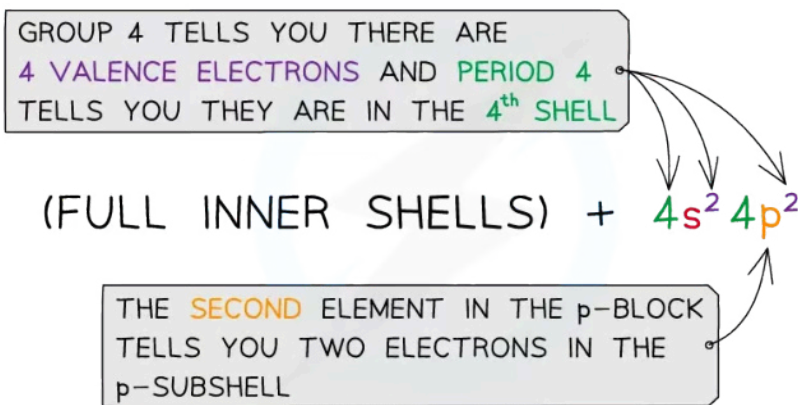

Copyright © Save My Exams. All Rights Reserved

Deducing the electron configuration of germanium

- Germanium is in **p block**, in **group 4** (using the simplified numbering system) and the **second** element across in **period 4**
- Group 4 tells you there are **four valence electrons** and period 4 tells you the **valence electrons** are in the **fourth shell**
- The **second** position in **p block** tells you that two electrons are in the **p subshell**
- Similarly, you can deduce the position of an element in the periodic table from its electron configuration:

How to write electronic configuration

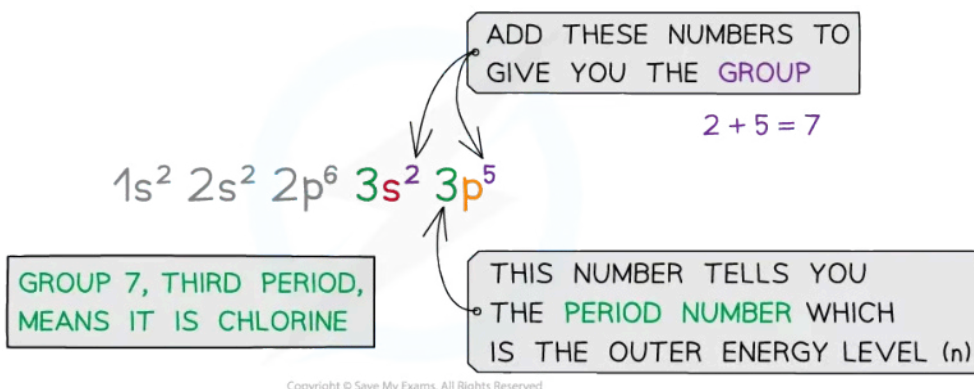

Deducing information from the electron configuration of chlorine

- Test your understanding in the following example:

Worked example

Element **Z** is in period 4 and group 5 of the periodic table. Which statement is correct?

- A. Z has 5 occupied energy levels.
- B. Z can form ions with 3- charge.
- C. Z is a transition element.
- D. Z has 4 valence electrons.

Answer:

- The correct option is **B**
 - A group 5 element can form a 3- ion
 - 5 occupied energy levels would place it in period 5, so **A** is incorrect
 - Transition elements would not be found in group 5, so **C** is also incorrect
 - 4 valence electrons would match an element in group 4, so **D** must be wrong



Your notes

Periodic Trends

Periodicity

Atomic radius

- The **atomic radius** of an element is a measure of the size of an atom
- It is the distance between the **nucleus** of an atom and the outermost electron shell
- It can be quite hard to determine exactly where the boundary of an atom lies, so a variety of approaches are taken such as half the mean distance between two adjacent atoms
- This will vary depending on the type of structure and bonding, but it gives a comparative value for atoms

Atomic radius diagram

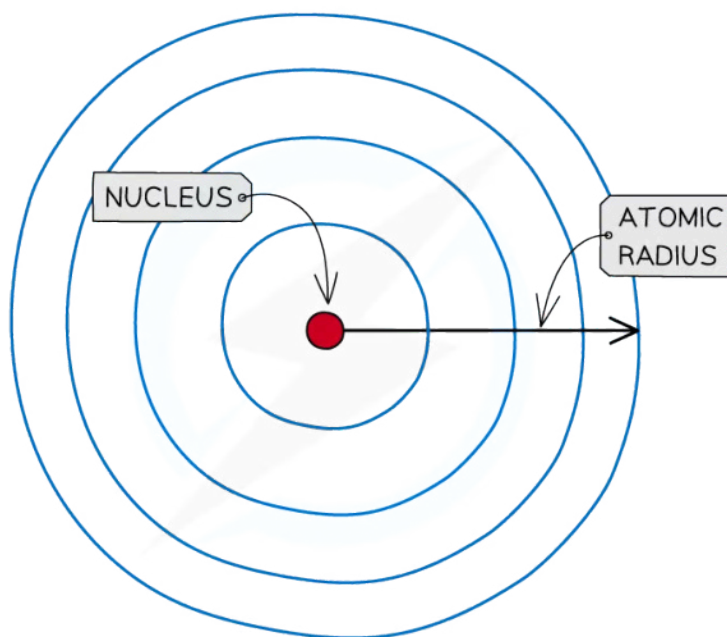

Copyright © Save My Exams. All Rights Reserved

The atomic radius of an atom is the typical distance between the nucleus and the outermost electron shell

Trends in atomic radii

- Atomic radii show predictable patterns across the periodic table
 - They generally **decrease** across each period
 - They generally **increase** down each group
- These trends can be explained by the **electron shell theory**

- Atomic radii decrease as you move across a period as the atomic number increases (increased positive **nuclear charge**) but at the same time extra electrons are added to the same **principal quantum shell**
- The larger the nuclear charge, the greater the pull of the nuclei on the electrons which results in smaller atoms
- Atomic radii increase moving down a group as there is an increased number of shells going down the group
- The electrons in the **inner shells** repel the electrons in the **outermost shells**, **shielding** them from the positive nuclear charge
- This weakens the pull of the nuclei on the electrons resulting in larger atoms

Diagram to show the trends in atomic radii

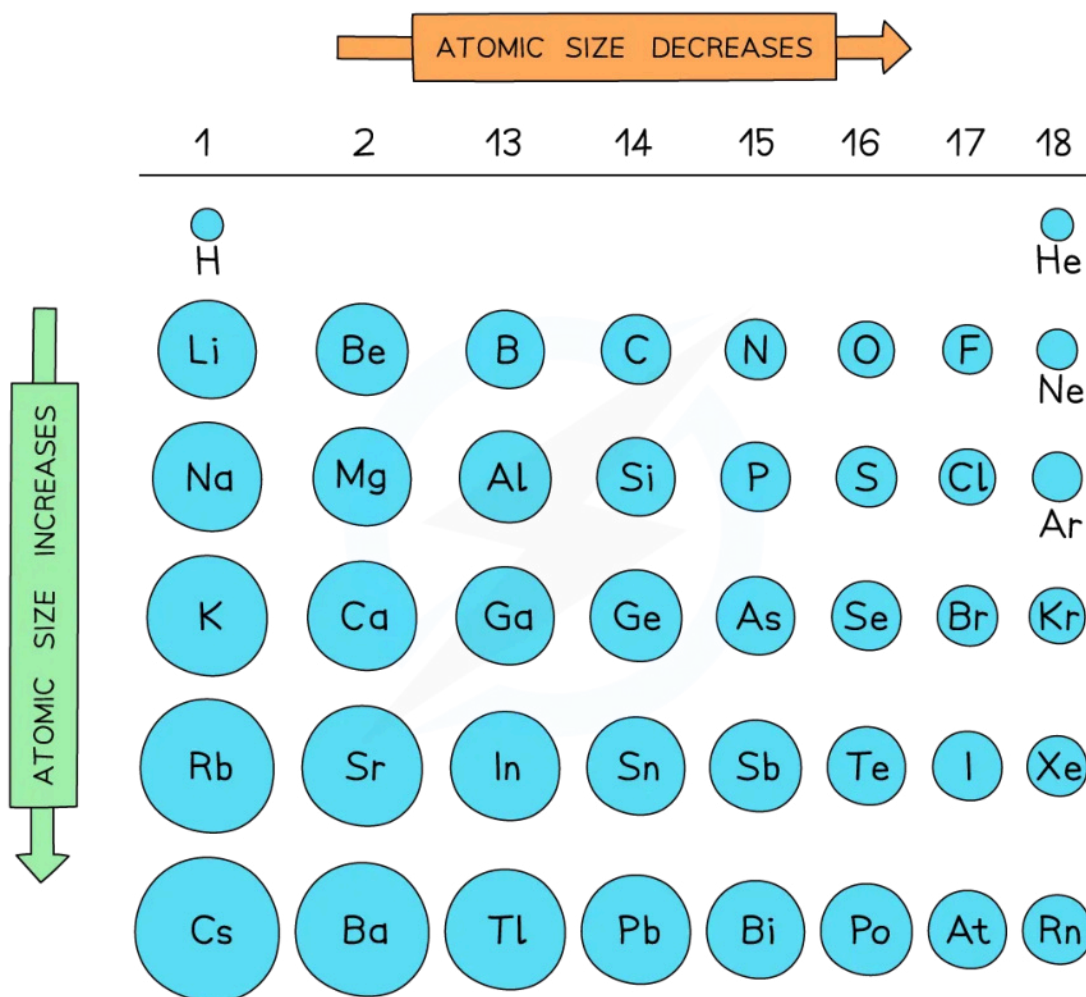

Copyright © Save My Exams. All Rights Reserved

Trends in the atomic radii across a period and down a group

- The diagram shows that the atomic radius increases sharply between the noble gas at the end of each period and the alkali metal at the beginning of the next period
- This is because the alkali metals at the beginning of the next period have one extra principal quantum shell
 - This increases the shielding of the outermost electrons and therefore increases the atomic radius



Your notes













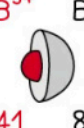
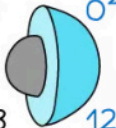

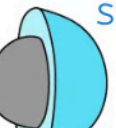

Ionic radius

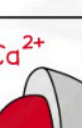
- The **ionic radius** of an element is a measure of the size of an ion
 - The trend down a group is the same as atomic radius - it increases as the number of shells increases
 - The trend across a period is not so straightforward as it depends on whether it is positive or negative ions are considered
 - Ionic radii **increase** with increasing **negative charge**
 - Ionic radii **decrease** with increasing **positive charge**
- These trends can also be explained by the **electron shell theory**
 - Ions with **negative** charges are formed by atoms **accepting** extra electrons while the **nuclear charge** remains the same
 - The extra electrons experience repulsion with the other valence electrons which increases the ionic radius
 - The greater the negative charge, the larger the ionic radius
 - **Positively** charged ions are formed by atoms **losing** electrons
 - The **nuclear charge** remains the same but there are now fewer electrons which undergo a **greater electrostatic force of attraction** towards the nucleus which decreases the ionic radius
 - The greater the positive charge, the smaller the ionic radius

Diagram to show the trends in ionic radii

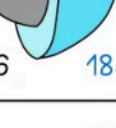

Your notes

	GROUP 1	GROUP 2	GROUP 13	GROUP 16	GROUP 17
PERIOD 2	Li^+ Li  90 134	Be^{2+} Be  59 90	B^{3+} B  41 82	O O^{2-}  73 126	F F^-  71 119
PERIOD 3	Na^+ Na  116 154	Mg^{2+} Mg  86 130	Al^{3+} Al  68 118	S S^{2-}  102 170	Cl Cl^-  99 167
PERIOD 4	K^+ K  152 196	Ca^{2+} Ca  114 174	Ga^{3+} Ga  76 126	Se Se^{2-}  116 184	Br Br^-  114 182
PERIOD 5	Rb^+ Rb  166 211	Sr^{2+} Sr  132 192	In^{3+} In  94 144	Te Te^{2-}  135 207	I I^-  133 206

Copyright © Save My Exams. All Rights Reserved

Trends in the ionic radii across a period and down a group



Your notes

Worked example

Which option shows atoms in order of decreasing atomic radius?

- A. $N > C > Be > Mg$
- B. $Mg > N > C > Be$
- C. $Be > C > N > Mg$
- D. $Mg > Be > C > N$

Answer:

- Option **D** is the correct answer
 - First, you need to identify that Be, C and N are all in Period 2, but Mg is in Period 3, so Mg will have the biggest radius.
 - Secondly, the atomic radius decreases across the period so Be, C and N decrease in that order as they belong to Groups 2, 14 and 15, respectively

Ionisation energy

- The **ionisation energy (IE)** of an element is the amount of energy required to remove **one mole** of electrons from **one mole** of atoms of an element in the gaseous state to form **one mole** of gaseous ions
- Ionisation energies are measured under **standard conditions** which are 298 K and 100 kPa
- The units of IE are **kilojoules per mole** (kJ mol^{-1})
- E.g. the first ionisation energy of calcium:
 - The **first ionisation energy** is the energy required to remove one mole of electrons from one mole of gaseous atoms

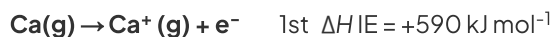

Trends in ionisation energy

- Ionisation energies show **periodicity**
- As could be expected from their electronic configuration, the Group 1 metals show low IE whereas the noble gases have very high IEs
- The **first ionisation energy increases** across a period and **decreases** down a group and is caused by **four factors** that influence the ionisation energy:
 - **Size of the nuclear charge:** the nuclear charge increases with increasing atomic number, which means that there are greater **attractive forces** between the nucleus and outer electrons, so more energy is required to overcome these attractive forces when removing an electron
 - **Distance of outer electrons from the nucleus:** electrons in shells that are further away from the nucleus are less attracted to the nucleus so the further the outer electron shell is from the nucleus, the **lower** the ionisation energy
 - **Shielding effect of inner electrons:** the **shielding effect** is when the electrons in full inner shells repel electrons in outer shells preventing them to feel the **full nuclear charge** so the greater the

shielding of outer electrons by inner electron shells, the lower the ionisation energy

- **Spin-pair repulsion:** paired electrons in the same atomic orbital in a subshell repel each other more than electrons in different atomic orbitals; this makes it easier to remove an electron (which is why the first ionisation energy is always the lowest)



Your notes

Graph to show the trend in ionisation energies from H to Na

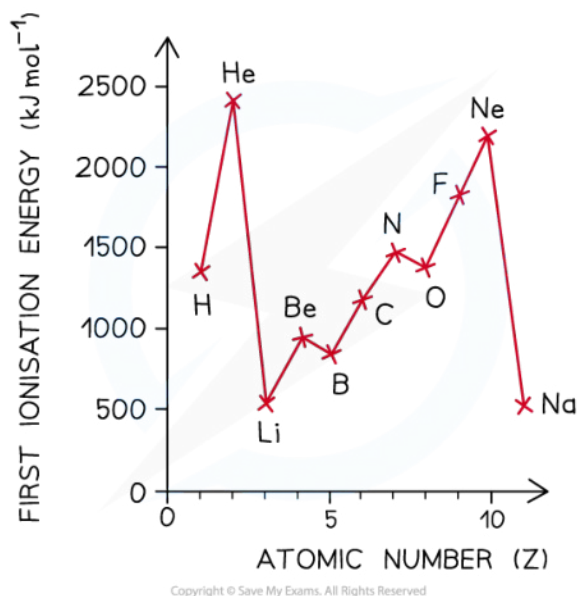

A graph showing the ionisation energies of the elements hydrogen to sodium

Ionisation energy across a period

- The ionisation energy across a period increases due to the following factors:
 - Across a period the **nuclear charge** increases
 - The **distance** between the nucleus and outer electron remains reasonably **constant**
 - The **shielding** by inner shell electrons remains the same
- There is a rapid **decrease** in ionisation energy between the **last** element in one period and the **first** element in the next period caused by:
 - The increased **distance** between the nucleus and the outer electrons
 - The increased **shielding** by inner electrons
 - These two factors outweigh the increased **nuclear charge**

Ionisation energy down a group

- Although going down a group the **nuclear charge** increases, the ionisation energy down a group decreases and it is due to the following factors:
 - The **distance** between the nucleus and the outer electron **increases**
 - The **shielding** by inner shell electrons **increases**

- The **effective nuclear charge** is decreasing as **shielding** increases



Your notes

Ionisation Energy Trends across a Period & going down a Group Table

Across a Period: Ionisation Energy Increases	Down a Group: Ionisation Energy Decreases
Increase in nuclear charge	Increase in nuclear charge
Shell number is the same The distance of outer electrons to the nucleus is the same	Increase in shells Distance of outer electron to nucleus increases The shielding effect increases, therefore, the attraction of outer electrons to the nucleus decreases
Shielding remains reasonably constant	Increased shielding
Decreased atomic/ionic radius	Increases atomic/ionic radius
The outer electron is held more tightly to the nucleus so it gets harder to remove it	The outer electron is held more loosely to the nucleus so it gets easier to remove it

Electron affinity

- When atoms gain electrons they become negative ions or **anions**
- Electron affinity (EA)** can be thought of as the opposite process of ionisation energy and is defined as
 - The amount of energy released when **one mole** of electrons is gained by **one mole** of atoms of an element in the gaseous state to form **one mole** of gaseous ions
- Electron affinities are measured under **standard conditions** which are 298 K and 100 kPa
- The units of EA are **kilojoules per mole** (kJ mol^{-1})
- The **first electron affinity** is always exothermic, e.g.

$$\text{Cl}(g) + e^{-} \rightarrow \text{Cl}^{-}(g) \quad \Delta H = -349 \text{ kJ mol}^{-1}$$
- However, the second electron affinity can be an endothermic process, e.g.

$$\text{O}^{-}(g) + e^{-} \rightarrow \text{O}^{2-}(g) \quad \Delta H = +753 \text{ kJ mol}^{-1}$$
- This is due to the fact that you are overcoming repulsion between the electron and a negative ion, so energy is required making the process endothermic overall

Trends in electron affinity

Graph to show the electron affinities across a period

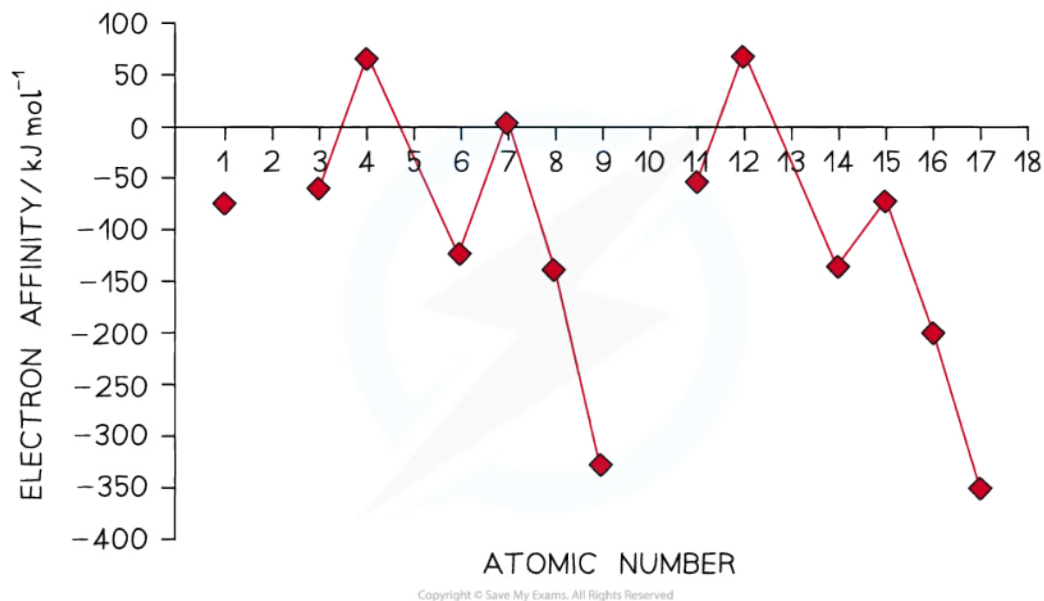

Graph to show the electron affinities from lithium to chlorine

- Electron affinities show **periodicity**
- The pattern is very **similar** to ionisation energies, except that it is inverted and the minimum points are displaced one element to the right
- As might be expected, the most exothermic electron affinities are for Group 17 elements which also have the highest electronegativities
- The strongest pull on electrons correlates with the greater amount of energy released when negative ions are formed
- Noble gases do not form negative ions, so they don't appear in this chart
- The electron affinities reach a peak for Group 2 and Group 5 elements

Graph to show the electron affinities down a group

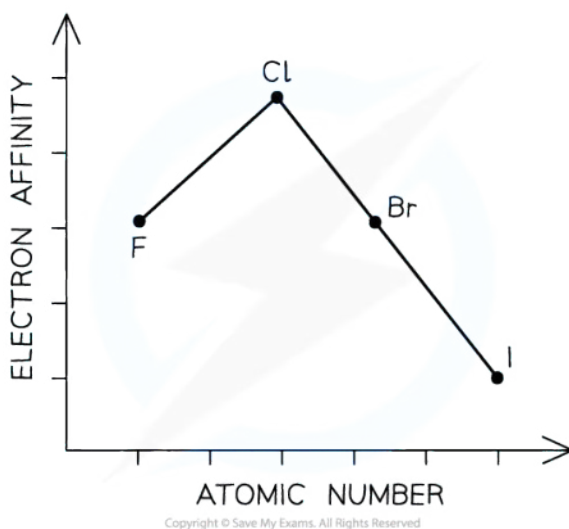

Electron affinities down Group 17 from F to I

- **Electron affinities** generally decrease down a group
- As the atoms become larger the attraction for an additional electron is less, since the **effective nuclear charge** is reduced due to increased **shielding**
- Electron affinity become **less exothermic** going down the group
- An exception to this is fluorine whose **electron affinity** is smaller than expected
- This is because fluorine is such a small atom and an additional electron in the 2p subshell experiences considerable repulsion with the other valence electrons

Electronegativity

- **Electronegativity** is the ability of an atom to attract a pair of electrons towards itself in a covalent bond
- This phenomenon arises from the **positive** nucleus's ability to attract the **negatively** charged electrons, in the outer shells, towards itself
- **Electronegativity** varies across periods and down the groups of the periodic table

Across a period

- Electronegativity **increases** across a period
- The **nuclear charge increases** with the addition of protons to the nucleus
- **Shielding** remains the **same** across the period as no new shells are being added to the atoms
- The nucleus has an increasingly strong attraction for the bonding pair of electrons of atoms across the period
- This results in **smaller atomic radii**

Diagram to show the trend in electronegativity across a period



Your notes

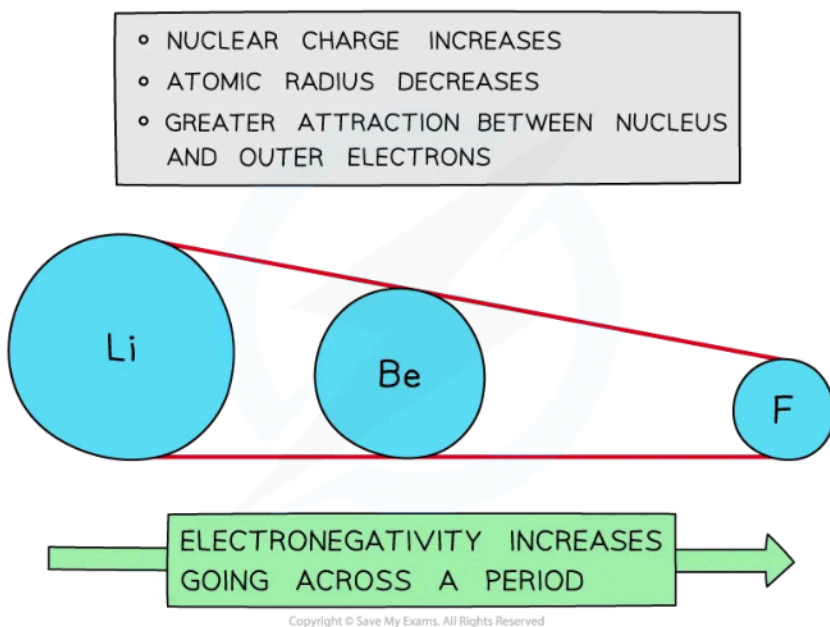

Electronegativity increases going across the periods of the periodic table

Down a group

- There is a **decrease** in **electronegativity** going down the group
- The **nuclear charge increases** as more protons are added to the nucleus
- However, each element has an extra filled electron shell, which increases the **shielding**
- The addition of the extra shells increases the distance between the nucleus and the outer electrons resulting in **larger atomic radii**
- Overall, there is a decrease in attraction between the nucleus and outer bonding electrons
- We say the **effective nuclear charge** has decreased down the group

Diagram to show the trend in electronegativities down a group

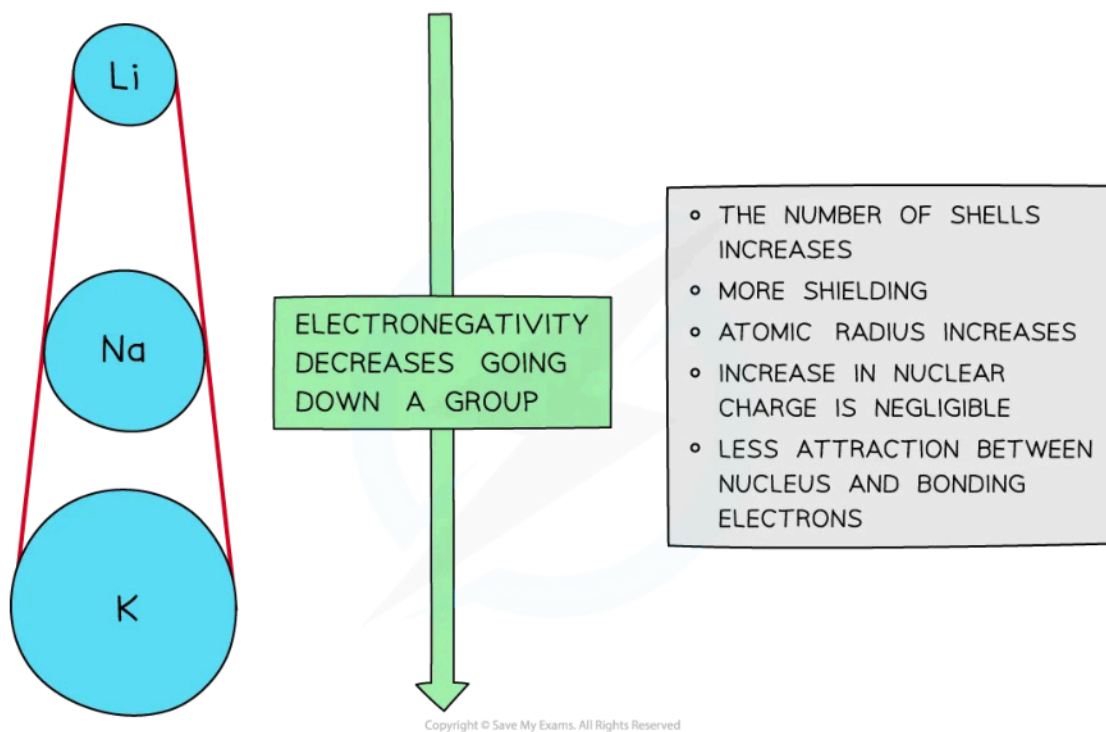

Electronegativity decreases going down the groups of the periodic table

Table of trends down a group & across a period

	Down a group	Across a period
Nuclear charge	Increases	Increases
Shielding	Increases	Reasonably constant
Atomic radius	Increases	Decreases
Electronegativity	Decreases	Increases

 **Examiner Tip**

- Make sure you learn the definition of **electronegativity** and can distinguish it from **electron affinity** as the two are often confused
- **Electronegativity** is about chemical character and only applies to considerations of covalent bonds whereas **electron affinity** is a thermodynamic value that is measurable and applies to the formation of negative ions
- You may come across something called **electropositivity** - this is a term used to describe the character of elements to form positive ions and is useful when talking about metal atoms and metal ions



Your notes



Your notes

Group 1 Metals with Water

Group 1 Metals with Water

The Group 1 metals

- The Group 1 metals are called the **alkali metals** because they form **alkaline solutions** with high pH values when reacted with water
- Group 1 metals are lithium, sodium, potassium, rubidium, caesium and francium
- They all end in the electron configuration ns^1

Physical properties of the Group 1 metals

- The Group 1 metals:
 - Are soft and easy to cut, getting **softer** and **denser** as you move down the group
 - Have **shiny** silvery surfaces when freshly cut
 - Conduct **heat** and **electricity**
 - They all have **low** melting points and **low** densities and the melting point **decreases** going down the group as the atomic radius increases and the metallic bonding gets weaker

Group 1 metals in The Periodic Table

GROUP METALS																	0
1	2											3	4	5	6	7	He
Li	Be											B	C	N	O	F	Ne
Na	Mg											Al	Si	P	S	Cl	Ar
K	Ca	Sc	Ti	V	Cr	Mn	Fe	Co	Ni	Cu	Zn	Ga	Ge	As	Se	Br	Kr
Rb	Sr	Y	Zr	Nb	Mo	Tc	Ru	Rh	Pd	Ag	Cd	In	Sn	Sb	Te	I	Xe
Cs	Ba	La	Hf	Ta	W	Re	Os	Ir	Pt	Au	Hg	Tl	Pb	Bi	Po	At	Rn
Fr	Ra	Ac															

Copyright © Save My Exams. All Rights Reserved



The alkali metals are located on the left of the periodic table in the first column of the s block

Chemical properties of the Group 1 metals

- They react readily with oxygen and water vapour in air so they are usually kept under **oil** to stop them from reacting

- Group 1 metals will react similarly with water, reacting vigorously to produce an **alkaline** metal hydroxide solution and **hydrogen** gas



Your notes

Table of the reactions of Group 1 metals and water

Element	Reaction
Lithium	$2\text{Li (s)} + 2\text{H}_2\text{O (l)} \rightarrow 2\text{LiOH (aq)} + \text{H}_2 \text{ (g)}$ Lithium floats and reacts slowly H ₂ gas released, lithium keeps shape
Sodium	$2\text{Na (s)} + 2\text{H}_2\text{O (l)} \rightarrow 2\text{NaOH (aq)} + \text{H}_2 \text{ (g)}$ Sodium reacts with a vigorous release of H ₂ gas Heat produced sufficient to melt the unreacted metal, which forms a small ball that moves around on the water surface NaOH formed which produces a highly alkaline solution
Potassium	$2\text{K (s)} + 2\text{H}_2\text{O (l)} \rightarrow 2\text{KOH (aq)} + \text{H}_2 \text{ (g)}$ Reacts more violently than sodium, bubbles of H ₂ gas, melts into a shiny ball that dashes around on the surface Hot enough to ignite H ₂ gas, potassium burns with a lilac flame



Your notes

Worked example

What would you see when sodium is added to water?

- I. A gas is given off
- II. The temperature of the water increases
- III. A clear, colourless solution is formed

- A. I and II only
- B. I and III only
- C. II and III only
- D. I, II and III

Answer

- The correct option is **D**
 - Bubbles of hydrogen gas are given off
 - The sodium melts, so that tells you it is an exothermic reaction
 - The product, sodium hydroxide, is very soluble so a clear, colourless solution would be formed

Alkali metals with halogens

- All the **alkali metals** react vigorously with the **halogens** in Group 17
- The reaction results in an **alkali metal halide salt**
$$2\text{Na (s)} + \text{Cl}_2 \text{(g)} \rightarrow 2\text{NaCl (s)}$$
- The reaction becomes increasingly vigorous going down Group 1 because:
 - The atoms of each element get **larger** going down the group
 - This means that the **ns¹** electron gets **further away** from the nucleus and is **shielded** by more electron shells.
 - The further an electron is from the positive nucleus, the easier it can be lost in reactions



Your notes

Worked example

Which pair of elements has the most vigorous reaction?

- A. Cs and I
- B. Li and Cl
- C. Cs and F
- D. Li and F

Answer

- The correct option is **C**.
 - You need to choose the lowest element in Group 1 and the highest element in Group 17 to predict the most vigorous reaction
 - This is because reactivity increases going down Group 1, but decreases going down Group 17



Your notes

Group 17 Elements with Halide Ions

Group 17 Elements with Halide Ions

The Halogens

- These are the Group 17 non-metals that are **poisonous** and include fluorine, chlorine, bromine, iodine and astatine
- Halogens are **diatomic**, meaning they form molecules of **two** atoms
- All halogens have seven electrons in their outer shell
- They form **halide** ions by gaining one more electron to complete their outer shells

Colours and States at Room Temperature

Halogen	Physical state at room temperature	Colour	Colour in solution
Fluorine	Gas	Yellow	-
Chlorine	Gas	Pale Green	Green-blue
Bromine	Liquid	Red-brown (readily evaporates to form a brown gas)	Orange
Iodine	Solid	Grey-black (sublimes to form a purple gas)	Dark brown

Trends in physical properties of the halogens

Melting point

- The density and melting and boiling points of the halogens **increase** as you go down the group

Trend in the melting and boiling points of the halogens

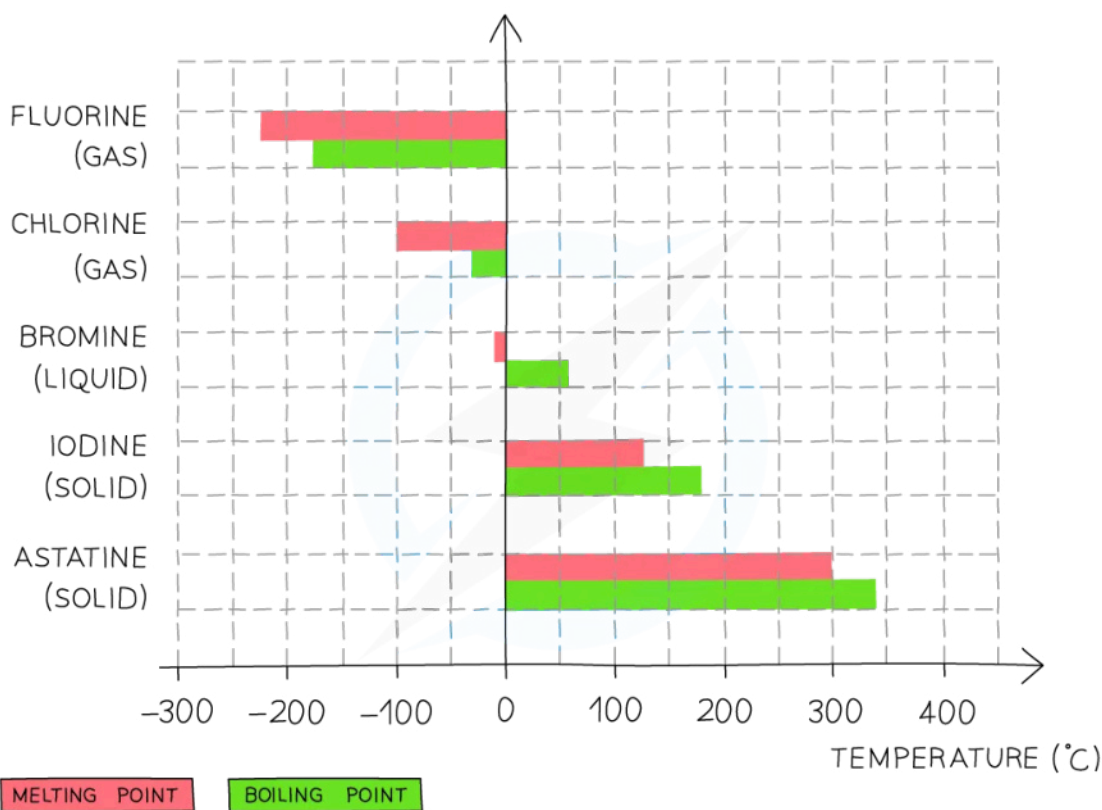

Copyright © Save My Exams. All Rights Reserved



The melting and boiling points increase down the group

Explaining the trend in reactivity in Group 17

- The reactivity of Group 17 non-metals **decreases** as you go down the group
- The halogens electron configurations all end in ns^2np^5
- Each outer shell contains seven electrons and when they react, they will need to gain one outer electron to get a full outer shell of electrons
- Going down the group, the **electron affinity** decreases and the **atomic radius** increases
- As you go down Group 17, the number of shells of electrons **increases** so **shielding** also increases
- This means that the outer electrons are **further** from the nucleus so there are **weaker** electrostatic forces of attraction that attract the extra electron needed
- The electron is attracted less readily, so the **lower** down the element is in Group 17 the **less reactive** it is

Reaction of the halogens with halide ions in displacement reactions

- A halogen **displacement** occurs when a **more** reactive halogen displaces a **less** reactive halogen from an aqueous solution of its halide
- The reactivity of Group 17 non-metals increases as you move up the group
- Out of chlorine, bromine and iodine, chlorine is the most reactive and iodine is the least reactive

Aqueous Solution Colour of Halogens

Aqueous solution	Colour
Chlorine	Very pale green, but usually appears colourless as it is very dilute
Bromine	Orange but will turn yellow when diluted
Iodine	Brown



Your notes

Halogen displacement reactions

Chlorine and bromine

- If you add chlorine solution to colourless potassium bromide solution, the solution becomes orange as bromine is formed
- Chlorine is **above** bromine in Group 17 so it is more reactive
- Chlorine will therefore **displace** bromine from an aqueous solution of a metal bromide

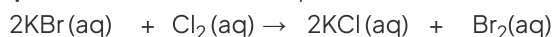

potassium bromide + chlorine → potassium chloride + bromine

Bromine and iodine

- Bromine is **above** iodine in Group 17 so it is **more** reactive
- Bromine will therefore **displace** iodine from an aqueous solution of a metal iodide

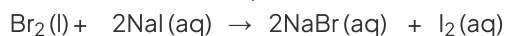

bromine + sodium iodide → sodium bromide + iodine



Your notes

Worked example

Which of the statements below are correct?

- I. Potassium chloride solution will react with fluorine to form chlorine.
- II. Sodium chloride solution will react with iodine to form chlorine.
- III. Lithium iodide solution will react with bromine to form iodine.

- A. I and II only
- B. I and III only
- C. II and III only
- D. I, II and III

Answer

- The correct option is **B**.
 - Fluorine will displace chlorine as it is higher up in the group
 - Bromine will displace iodine for the same reason.
 - Iodine is below chlorine so cannot displace chlorine from sodium chloride



Your notes

Metallic & Non-Metallic Oxides

Metallic & Non-Metallic Oxides

Oxides across a period

- The **acid-base** character of the oxides provides evidence of chemical trends in the periodic table
- The broad trend is that oxides change from **basic** through **amphoteric** to **acidic** across a period
- Aluminium oxide is **amphoteric** which means that it can act both as a base (and react with an acid such as HCl) and an acid (and react with a base such as NaOH)

Acidic & Basic Nature of the Period 3 Oxides

Period 3 oxide	Na ₂ O	MgO	Al ₂ O ₃	SiO ₂	P ₄ O ₁₀	SO ₂ , SO ₃
Acid / base nature	Basic	Basic	Amphoteric	Acidic	Acidic	Acidic

- The acidic and basic nature of the Period 3 elements can be explained by looking at their **structure**, **bonding** and the Period 3 elements' **electronegativity**

Structure, Bonding & Electronegativity of the Period 3 Elements Table

Period 3 oxide	Na ₂ O	MgO	Al ₂ O ₃	SiO ₂	P ₄ O ₁₀	SO ₂ , SO ₃	-	-
Relative melting point	High	High	Very high	Very high	Low	Low	-	-
Chemical bonding	Ionic	Ionic	Ionic (with some degree of covalent character)	Covalent	Covalent	Covalent	-	-
Structure	Giant ionic	Giant ionic	Giant ionic	Giant covalent	Simple molecular	Simple molecular	-	-
Element	Na	Mg	Al	Si	P	S	Cl	O
Electronegativity	0.9	1.2	1.5	1.8	2.1	2.5	3.0	3.5

- The difference in electronegativity between oxygen and Na, Mg and Al is the largest
- Electrons will therefore be **transferred** to oxygen when forming oxides giving the oxide an **ionic bond**

- The oxides of Si, P and S will **share** the electrons with the oxygen to form **covalently bonded** oxides
- The oxides of **Na** and **Mg** which show purely **ionic bonding** produce **alkaline** solutions with water as their **oxide** ions (O^{2-}) become **hydroxide** ions (OH^-):



- The oxides of **P** and **S** which show purely **covalent bonding** produce **acidic** solutions with water because when these oxides react with water, they form an acid which donates H^+ ions to water
 - Eg. SO_3 reacts with water as follows:

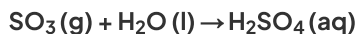

- The H_2SO_4 is an acid which will donate an H^+ to water:

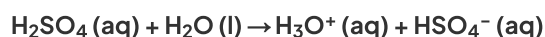

Examiner Tip

Only examples of general trends across periods and groups are required, but you should be able to link trends in ionization energy, electron affinity and electronegativity with trends in chemical character such as the nature of the oxides and metallic / non-metallic behaviour

- The pH changes for the reactions of the oxides with water can be explained by reference to the following equations:

Table of the reaction of oxides with water

Oxide	Chemical equation	pH
Na₂O	$Na_2O (s) + H_2O (l) \rightarrow 2NaOH (aq)$	14 (strongly alkaline)
MgO	$MgO (s) + H_2O (l) \rightarrow Mg(OH)_2 (aq)$	10 (weakly alkaline)
P₄O₁₀	$P_4O_{10} (s) + 6H_2O (l) \rightarrow 4H_3PO_4 (aq)$	2 (strongly acidic)
NO₂	$2NO_2 (aq) + H_2O (l) \rightarrow HNO_3 (aq) + HNO_2 (aq)$	1 (strongly acidic)
SO₂ SO₃	$SO_2 (g) + H_2O (l) \rightarrow H_2SO_3 (aq)$ $SO_3 (g) + H_2O (l) \rightarrow H_2SO_4 (aq)$	1 (strongly acidic)

- The pattern here is that:
 - The metallic oxides form hydroxides when they react with water

- The non-metallic oxides form oxoacids when they react with water

Examiner Tip

You should learn how to construct these equations exactly as they are specifically mentioned in the syllabus

- The position of an element in the periodic table can be used to predict and explain its **metallic** and **non-metallic** behaviour
 - This is illustrated by the bonding of the oxides
 - Metal and non-metal elements generally form **ionic** compounds so the elements **Na** to **Al** have **giant ionic structures**
 - The oxides become more **ionic** as you go **down the group** as the **electronegativity decreases**
 - The oxides become less **ionic** as you go **across a period** as the **electronegativity increases**
 - The oxides of non-metals such as **S**, **N** and **P** form **molecular covalent compounds**
-
- Sometimes you may be asked to make predictions about oxides that are not specifically mentioned in the syllabus but you should be able to deduce their properties if you understand the patterns outlined above, as the following example shows:

Worked example

Which of these oxides produces the solution with the highest pH when added to water?

- A. CO_2
- B. SO_3
- C. CaO
- D. Na_2O

Answer:

- The correct option is **D**
 - CO_2 and SO_3 will produce a pH below 7 as they are non-metal oxides
 - CaO and Na_2O will produce a pH above 7 as they are metal oxides
 - However, the pH decreases as you go across a period, so Na_2O will have a higher pH than CaO



Your notes



Your notes

Oxidation States

Oxidation States

Oxidation and reduction

- There are three definitions of **oxidation** and **reduction** used in different branches of chemistry
- Oxidation** and **reduction** can be used to describe any of the following processes

Definitions and Examples of Oxidation & Reduction Table

Oxidation	Reduction
Addition of oxygen e.g. $2\text{Mg} + \text{O}_2 \rightarrow \text{MgO}$	Loss of oxygen e.g. $2\text{CuO} + \text{C} \rightarrow 2\text{Cu} + \text{CO}_2$
Loss of hydrogen e.g. $\text{CH}_3\text{OH} \xrightarrow{[\text{O}]} \text{CH}_2\text{O} + \text{H}_2\text{O}$	Gain of hydrogen e.g. $\text{C}_2\text{H}_4 + \text{H}_2 \rightarrow \text{C}_2\text{H}_6$
Loss of electrons e.g. $\text{Al} \rightarrow \text{Al}^{3+} + 3\text{e}^-$	Gain of electrons e.g. $\text{F}_2 + 2\text{e}^- \rightarrow 2\text{F}^-$

Oxidation Number

- The **oxidation number or state** of an atom is the charge that would exist on an individual atom if the bonding were completely ionic
- It is like the electronic 'status' of an element
- Oxidation numbers** are used to...
 - tell if oxidation or reduction has taken place
 - work out what has been oxidised and/or reduced
 - construct half equations and balance redox equations

Atoms and simple ions

- The oxidation number is the number of electrons which must be added or removed to become neutral
- The oxidation number is always written with the charge before the number

Oxidation Number of Simple Ions Table

Atoms	Na in Na = 0	Neutral already, no need to add any electrons
Cations	Na in Na^+ = +1	Need to add 1 electron to make Na^+ neutral

Anions	Cl in $\text{Cl}^- = -1$	Need to take 1 electron away to make Cl^- neutral
--------	--------------------------	--



Worked example

What are the oxidation states of the elements in the following species?

1. C
2. Fe^{3+}
3. Fe^{2+}
4. O^{2-}
5. He
6. Al^{3+}

Answers:

1. 0
2. +3
3. +2
4. -2
5. 0
6. +3

- So, in simple ions, the oxidation number of the atom is the charge on the ion:
 - Na^+ , K^+ , H^+ all have an oxidation number of +1
 - Mg^{2+} , Ca^{2+} , Pb^{2+} all have an oxidation number of +2
 - Cl^- , Br^- , I^- all have an oxidation number of -1
 - O^{2-} , S^{2-} all have an oxidation number of -2

Molecules or Compounds

- In molecules or compounds, the sum of the oxidation numbers on the atoms is zero

Oxidation Number in Molecules or Compounds Table

Elements	H in $\text{H}_2 = 0$	Both are the same and must add up to zero
Compounds	C in $\text{CO}_2 = +4$	$1 \times (+4) \text{ and } 2 \times (-2) = 0$
	O in $\text{CO}_2 = -2$	

- Since CO_2 is a neutral molecule, the sum of the oxidation states must be zero
- For this, one element must have a positive oxidation number and the other must be negative

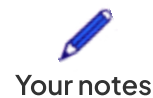

How do you determine which is the positive one?

- The more electronegative species will have the negative value
- Electronegativity increases across a period and decreases down a group
- O is further to the right than C in the periodic table so it has the negative value

How do you determine the value of an element's oxidation state?

- From its position in the periodic table and/or
- The other element(s) present in the formula
- Many atoms, such as S, N and Cl can exist in a variety of oxidation states
- The oxidation number of these atoms can be calculated by assuming that the oxidation number of the other atom is fixed
- Here are six rules to deduce the oxidation number of an element

Oxidation Number Rules Table

Rule	Example
1. The oxidation number of any uncombined element is zero	H ₂ Zn O ₂
2. Many atoms or ions have fixed oxidation numbers in compounds	Group 1 elements are always +1 Group 2 elements are always +2 Fluorine is always -1 Hydrogen is +1 (except for in metal hydrides like NaH, where it is -1) Oxygen is -2 (except in peroxides, where it is -1 and in F ₂ O where it is +2)
3. The oxidation number of an element in a mono-atomic ion is always the same as the charge	Zn ²⁺ = +2 Fe ³⁺ = +3 Cl ⁻ = -1
4. The sum of the oxidation number in a compound is zero	NaCl Na = +1 Cl = -1 Sum of oxidation numbers = 0



Your notes

5. The sum of oxidation numbers in an ion is equal to the charge on the ion	SO_4^{2-} $\text{S} = +6$ Four O atoms = $4 \times (-2)$ Sum of oxidation numbers = -2
6. In either a compound or an ion, the more electronegative element is given the negative oxidation number	F_2O Both F atoms = $2 \times (-1)$ $\text{O} = +2$ Sum of oxidation numbers = 0



Your notes

Worked example

State the oxidation number of the atoms in blue in these compounds or ions.

- a) P_2O_5
- b) SO_4^{2-}
- c) H_2S
- d) Al_2Cl_6
- e) NH_3
- f) ClO_2^-

Answer:

P_2O_5	$5 \text{ O atoms} = 5 \times (-2) = -10$ Overall charge compound = 0 $2 \text{ P atoms} = +10$ $\text{P} = +5$
SO_4^{2-}	$4 \text{ O atoms} = 4 \times (-2) = -8$ Overall charge compound = -2 $\text{S} = +6$
H_2S	$2 \text{ H atoms} = 2 \times (+1) = +2$ Overall charge compound = 0 $\text{S} = -2$
Al_2Cl_6	$6 \text{ Cl atoms} = 6 \times (-1) = -6$ Overall charge compound = 0 $2 \text{ Al atoms} = +6$ $\text{Al} = +3$
NH_3	$3 \text{ H atoms} = 3 \times (+1) = +3$



	Overall charge compound = 0 $N = -3$
ClO_2^-	$2 \text{ O atoms} = 2 \times (-2) = -4$ Overall charge compound = -1 $\text{Cl} = +3$

Are oxidation numbers always whole numbers?

- The answer is yes and no
- When you try and work out the oxidation of sulfur in the tetrathionate ion $\text{S}_4\text{O}_6^{2-}$ you get an interesting result!

Oxidation number of S in $\text{S}_4\text{O}_6^{2-}$

$$\begin{array}{c}
 \text{S}_4\text{O}_6^{2-} \\
 \downarrow \quad \quad \quad \searrow \\
 (? \times 4) + (-2 \times 6) = -2 \\
 (? \times 4) - 12 = -2 \\
 (? \times 4) = -2 + 12 \\
 ? = \frac{+10}{4} = +2\frac{1}{2}
 \end{array}$$

Copyright © Save My Exams. All Rights Reserved

The oxidation number of sulfur in $\text{S}_4\text{O}_6^{2-}$ is a fraction

- The fact that the oxidation number comes out to +2.5 does not mean it is possible to get half an oxidation number
 - This is only a mathematical consequence of four sulfur atoms sharing +10 oxidation number
 - The four sulfur atoms are in two different environments and the +2.5 is showing the average oxidation number of these two environments
- Single atoms can only have an integer oxidation number, because you cannot have half an electron!

Examiner Tip

- Oxidation number and oxidation state are often used interchangeably, though IUPAC does not distinguish between the two terms
- Oxidation numbers are represented by Roman numerals according to IUPAC

Naming Transition Metal Compounds

- **Transition metals** are characterized by having **variable oxidation numbers**.
- **Oxidation numbers** can be used in the names of compounds to indicate which **oxidation number** a particular element in the compound is in
- Where the element has a **variable oxidation number**, the number is written afterwards in **Roman numerals**.
- This is called the **STOCK NOTATION** (after the German inorganic chemist Alfred Stock), but is not widely used for non-metals, so SO_2 is sulphur dioxide rather than sulphur(IV) oxide
- For example, iron can be both +2 and +3 so **Roman numerals** are used to distinguish between them
 - Fe^{2+} in FeO can be written as **iron(II) oxide**
 - Fe^{3+} in Fe_2O_3 can be written as **iron(III) oxide**



Your notes



Your notes

Worked example

Name these transition metal compounds.

1. Cu_2O
2. MnSO_4
3. Na_2CrO_4
4. KMnO_4
5. $\text{Na}_2\text{Cr}_2\text{O}_7$

Answers:

1. Copper(I) oxide

- The oxidation number of 1 O atom is -2
- Cu_2O has overall no charge
- So, the oxidation number of Cu is +1

2. Manganese(II) sulfate

- The charge on the sulfate ion is -2
- So, the charge on Mn and oxidation number is +2

3. Sodium chromate(VI)

- The oxidation number of 2 Na atoms is +2
- Therefore, CrO_4 has an overall -2 charge
- So, the oxidation number of Cr is +6

4. Potassium manganate(VII)

- The oxidation number of a K atom is +1
- Therefore, MnO_4 has an overall -1 charge
- So, the oxidation number of Mn is +7

5. Sodium dichromate(VI)

- The oxidation number of 2 Na atoms is +2
- Therefore, Cr_2O_7 has an overall -2 charge
- So the oxidation number of Cr is +6
 - To distinguish it from CrO_4 we use the prefix di in front of the anion

Examiner Tip

- The answer to question 2 should strictly speaking be manganese (II) sulfate(VI) since sulfur is an element with a variable oxidation number
- However, the sulfate ion is a common ion whose name and formula you should know and you are only required to name transition metal compounds using Stock Notation



Your notes

Ionisation Energy Trends Across a Period (HL)

Ionisation Energy Trends Across a Period

- The trends in ionisation energy across a period and down a group have been discussed in our revision note on [Periodicity](#)
 - Trends in ionisation energy across a period provide evidence for the existence of energy sublevels

Graph showing Ionisation Energies From H to Ne

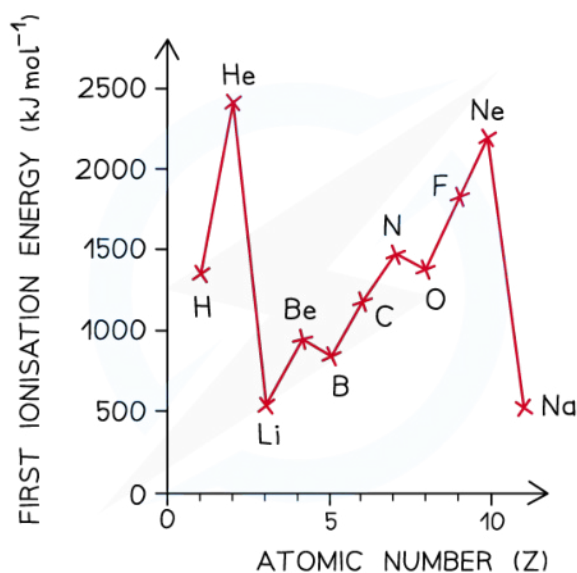

Copyright © Save My Exams. All Rights Reserved

A graph showing the ionisation energies of the elements hydrogen to sodium

- The ionization energy across a period increases due to the following factors:
 - Across a period the **nuclear charge** increases
 - The **distance** between the nucleus and outer electron remains reasonably **constant**
 - The **shielding** by inner shell electrons remains the same
- There is a rapid **decrease** in ionisation energy between the **last** element in one period and the **first** element in the next period caused by:
 - The increased **distance** between the nucleus and the outer electrons
 - The increased **shielding** by inner electrons
 - These two factors outweigh the increased **nuclear charge**

Exceptions to the general trend in ionisation energy

- There are discontinuities in the general trend which are caused by the following:
 - There is a slight **decrease** in 1st I.E. between **beryllium** and **boron** as the fifth electron in boron is in the 2p subshell which is further away from the nucleus than the 2s subshell of beryllium
 - Beryllium** has a first ionisation energy of **900 kJ mol⁻¹** as its electron configuration is **1s² 2s²**

- **Boron** has a first ionisation energy of 801 kJ mol^{-1} as its electron configuration is $1s^2 2s^2 2p^1$
- There is a slight **decrease** in 1st I.E. between **nitrogen** and **oxygen** due to **spin-pair repulsion** in the 2p subshell of oxygen
 - **Nitrogen** has a first ionisation energy of 1402 kJ mol^{-1} as its electron configuration is $1s^2 2s^2 2p^3$
 - **Oxygen** has a first ionisation energy of 1314 kJ mol^{-1} as its electron configuration is $1s^2 2s^2 2p^4$



Summary of Ionisation Energy Trends across a Period & going down a Group Table

Across a Period: Ionisation Energy Increases	Down a Group: Ionisation Energy Decreases
Increase in nuclear charge	Increase in nuclear charge
Shell number is the same The distance of the outer electron to the nucleus is the same	Increase in shells Distance of outer electron to nucleus increases The shielding effect increases, therefore, the attraction of valence electrons to the nucleus decreases
Shielding remains reasonably constant	Increased shielding
Decreased atomic/ionic radius	Increases atomic/ionic radius
The outer electron is held more tightly to the nucleus so it gets harder to remove it	The outer electron is held more loosely to the nucleus so it gets easier to remove it



Your notes

Characteristic Properties of Transition Elements (HL)

Characteristic Properties of Transition Elements

- Although the **transition elements** are metals, they have some properties unlike those of other metals on the periodic table, such as:
 - Variable **oxidation states**
 - High **melting points**
 - Have **magnetic properties**
 - Behave as **catalysts**
 - Use in catalytic converters and as biological catalysts
 - Form **coloured compounds**
 - Form **complex ions** with **ligands**
- These properties are a result of having an incomplete d sublevel

For more information about the electrical conductivity and high melting points of transition metals, see our revision note on the [Physical Properties of Transition Elements](#)

Variable Oxidation States

- Like other metals on the periodic table, the transition elements will lose electrons to form positively charged ions
- However, unlike other metals, transition elements can form more than one positive ion
 - They are said to have **variable oxidation states**
- Because of this, Roman numerals are used to indicate the oxidation state of the metal ion
 - For example, the metal sodium (Na) will only form Na^+ ions (no Roman numerals are needed, as the ion formed by Na will always have an oxidation state of +1)
 - The transition metal iron (Fe) can form Fe^{2+} (Fe(II)) **and** Fe^{3+} (Fe(III)) ions

Magnetic Properties

- Magnetism in transition metals is due to the presence of **unpaired electrons** in the **d-orbitals**
- Spinning electrons create a tiny **magnetic dipole**
- When paired electrons orientate themselves, the magnetic dipoles act in **opposite directions**, which means that there is **no overall magnetic effect**
- Most materials have paired electrons arranged like this, making them non-magnetic
- Some transition elements have unpaired electrons
- These unpaired electrons can be **aligned** in an external field resulting in magnetic properties
- The transition elements iron, cobalt and nickel have strong magnetic properties
 - The alloy steel also has strong magnetic properties because it contains iron
- They contain unpaired electrons in their d orbitals

Arrangement of electrons in orbitals for iron, cobalt and nickel



	4s	3d				
Fe [Ar]	$\uparrow\downarrow$	$\uparrow\downarrow$	\uparrow	\uparrow	\uparrow	\uparrow
Co [Ar]	$\uparrow\downarrow$	$\uparrow\downarrow$	$\uparrow\downarrow$	\uparrow	\uparrow	\uparrow
Ni [Ar]	$\uparrow\downarrow$	$\uparrow\downarrow$	$\uparrow\downarrow$	\uparrow	\uparrow	

Copyright © Save My Exams. All Rights Reserved

Iron, cobalt and nickel have strong magnetic properties because they contain unpaired electrons in their d orbitals

- If iron, cobalt and nickel are heated and cooled in a magnetic field, the magnetic field of the electrons remains
- Magnetic regions within the metal that are aligned magnetically are known as **domains**
- Banging or heating a permanent magnet will weaken the magnetism

Examiner Tip

- Previous specifications required you to know about the three types of magnetism:
 - **Diamagnetism**
 - **Paramagnetism**
 - **Ferromagnetism**
- The current specification states that "knowledge of different types of magnetism **will not be assessed**"

Transition elements as catalysts

- Transition metals are often used as catalysts in the elemental form or as compounds
- The ability of transition metals to form more than one stable oxidation state means that they can accept and lose electrons easily
- This enables them to catalyse certain redox reactions
 - They can be readily oxidised and reduced again, or reduced and then oxidised again
 - This is a consequence of transition metals having variable oxidation states
- There are two types of catalyst:
 - A **heterogeneous** catalyst is in a different physical state (phase) from the reactants
 - The reaction occurs at active sites on the surface of the catalyst
 - An example is the use of iron, Fe, in the Haber process for making ammonia

$$\text{N}_2(\text{g}) + 3\text{H}_2(\text{g}) = 2\text{NH}_3(\text{g})$$
 - A **homogeneous** catalyst is in the same physical state (phase) as the reactants

Further examples of transition metal catalysts

- The hydrogenation or reduction of alkenes makes use of a nickel catalyst

$$\text{CH}_2=\text{CH}_2(\text{g}) + \text{H}_2(\text{g}) \rightarrow \text{CH}_3\text{CH}_3(\text{g})$$

- The same reaction is used in the hydrogenation of vegetable oils
- The decomposition of hydrogen peroxide is a common reaction in the study of chemical kinetics and uses manganese(IV) oxide as the catalyst

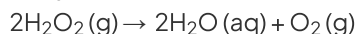

Catalytic converters

- Catalytic converters are used in car exhaust boxes to reduce air pollution
- They usually consist of a mixture of finely divided platinum and rhodium supported on a ceramic base

Catalytic converter diagram

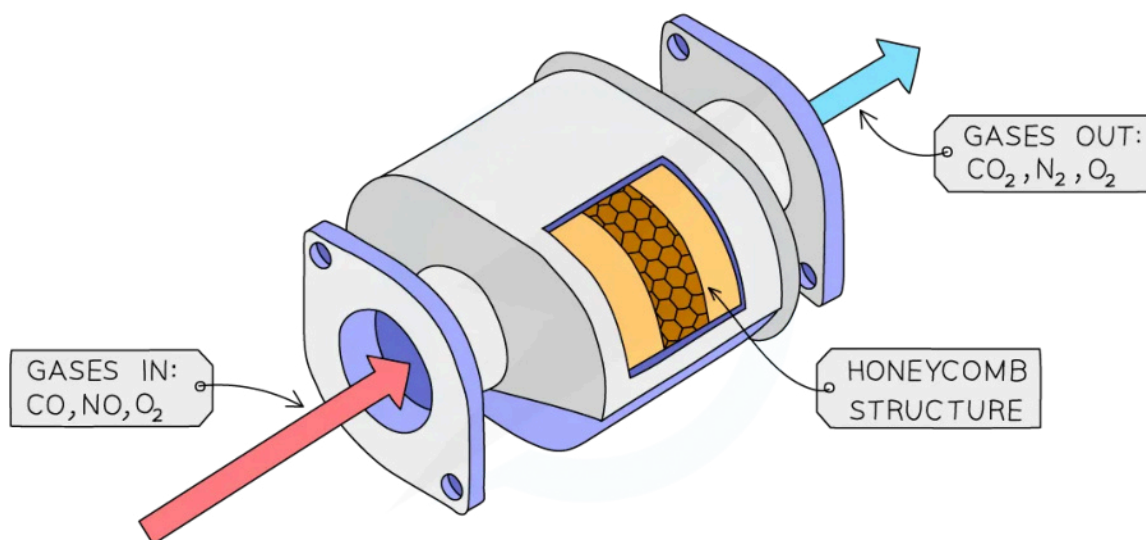

Copyright © Save My Exams. All Rights Reserved



The transition metal catalyst is on an inert support medium in a vehicle catalytic converter

- Carbon monoxide, nitrogen dioxide and unburnt hydrocarbons are sources of pollution in car exhaust
- The transition metal catalysts facilitate the conversion of these pollutants into less harmful products:

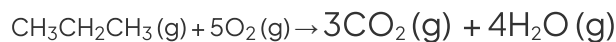
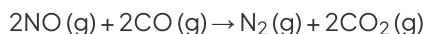

- Some transition metals are precious metals so they can be very expensive
 - In order to minimise the cost and maximise the efficiency of the catalyst the following measures can be taken:
 - Increasing the surface area of the catalyst
 - Coating an inert surface medium with the catalyst to avoid using large amounts of the catalyst
 - This is achieved by spreading the catalyst over a hollow matrix such as a honeycomb-like structure



Your notes

Biological catalysts

- Many of the enzyme catalysed reactions in the body make use of homogeneous transition metal catalysts
- An example of this is haemoglobin, abbreviated to Hb, which transports oxygen around the blood:

Haemoglobin structure diagram

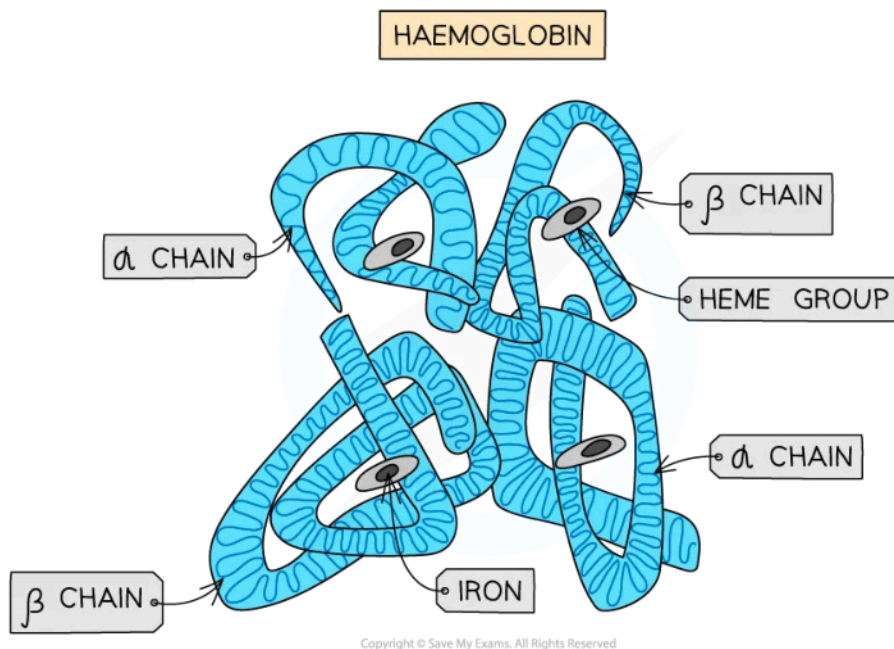

Haemoglobin contains haem units that are responsible for transporting oxygen

The structure of haem

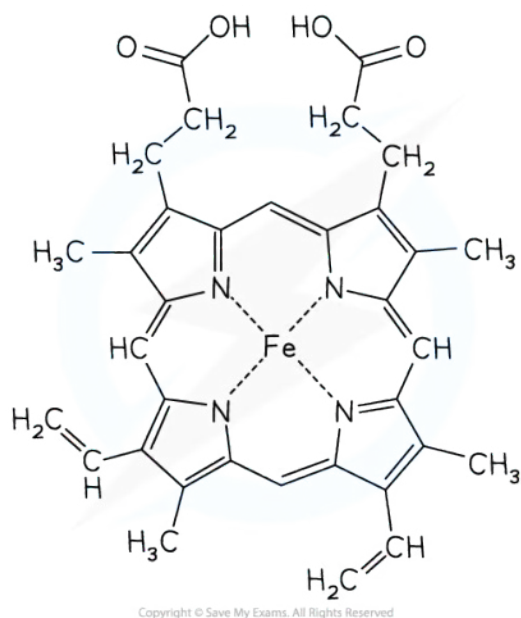

The haem unit contains an iron(II) ion

- The iron(II) ion is in the centre of a large heterocyclic ring called a **porphyrin**
- The iron has a coordination number of four, is square planar and can bind to one oxygen molecule
- The Hb molecule contains four porphyrin rings so each Hb can transport four oxygen molecules

Forming coloured compounds

- Another characteristic property of transition elements is that their compounds are often **coloured**
 - For example, the colour of the $[\text{Cr}(\text{OH})_6]^{3-}$ complex (where the oxidation state of Cr is +3) is **dark green**
 - Whereas the colour of the $[\text{Cr}(\text{NH}_3)_6]^{3+}$ complex (the oxidation state of Cr is still +3) is **purple**

For more information about transition metals as coloured compounds, see our revision note on [Colour in Transition Metal Complexes](#)

Forming Complex Ions

- Another property of transition elements caused by their ability to form variable oxidation states is the ability to form **complex ions**
- A complex ion consists of a central metal atom or ion, with a number of molecules or ions surrounding it
 - A molecule or ion surrounding the central metal atom or ion is called a ligand
- Due to the different oxidation states of the central metal ions, a different number and wide variety of ligands can form bonds with the transition element
 - For example, the chromium(III) ion can form $[\text{Cr}(\text{NH}_3)_6]^{3+}$, $[\text{Cr}(\text{OH})_6]^{3-}$ and $[\text{Cr}(\text{H}_2\text{O})_6]^{3+}$ complex ions

For more information about complex ions and transition metals, see our revision note on [Coordinate Bonds](#)



Your notes

Variable Oxidation States in Transition Elements (HL)

Variable Oxidation States in Transition Elements

Electron Configuration

- The full electronic configuration of the first-row transition metals is shown in the table below
- Following the **Aufbau Principle** electrons occupy the lowest energy subshells first
 - The 4s overlaps with the 3d subshell so the 4s is filled first
- Remember:** You can abbreviate the first five subshells, 1s-3p, to [Ar] representing the configuration of argon (known as the argon core)

Table showing the electronic configuration of the first d-series transition elements

Transition metal	Electronic configuration	Noble gas core electronic configuration
Ti	$1s^2 2s^2 2p^6 3s^2 3p^6 3d^2 4s^2$	[Ar] $3d^2 4s^2$
V	$1s^2 2s^2 2p^6 3s^2 3p^6 3d^3 4s^2$	[Ar] $3d^3 4s^2$
Cr	$1s^2 2s^2 2p^6 3s^2 3p^6 3d^5 4s^1$	[Ar] $3d^5 4s^1$
Mn	$1s^2 2s^2 2p^6 3s^2 3p^6 3d^5 4s^2$	[Ar] $3d^5 4s^2$
Fe	$1s^2 2s^2 2p^6 3s^2 3p^6 3d^6 4s^2$	[Ar] $3d^6 4s^2$
Co	$1s^2 2s^2 2p^6 3s^2 3p^6 3d^7 4s^2$	[Ar] $3d^7 4s^2$
Ni	$1s^2 2s^2 2p^6 3s^2 3p^6 3d^8 4s^2$	[Ar] $3d^8 4s^2$
Cu	$1s^2 2s^2 2p^6 3s^2 3p^6 3d^{10} 4s^1$	[Ar] $3d^{10} 4s^1$

- There are two exceptions to the **Aufbau Principle** in the first row of the d-block:
 - Chromium
 - Copper
- In both cases, an electron is promoted from 4s to 3d to achieve a half-full and full d-subshell, respectively
- Chromium and copper have the following electron configurations, which are different to what you may expect:



Your notes

- Cr is $[\text{Ar}] 3d^5 4s^1$ not $[\text{Ar}] 3d^4 4s^2$
- Cu is $[\text{Ar}] 3d^{10} 4s^1$ not $[\text{Ar}] 3d^9 4s^2$
- This is because the $[\text{Ar}] 3d^5 4s^1$ and $[\text{Ar}] 3d^{10} 4s^1$ configurations are energetically more stable and are preferred configurations
- When forming cations, remove the **4s** electrons first

Worked example

Deducing the electronic configuration of transition element ions

State the full electronic configuration of:

1. Cu
2. Mn(III) ions
3. V^{4+}

Answer 1 – Cu:

- Cu atomic number = 29
- $1s^2 2s^2 2p^6 3s^2 3p^6 3d^{10} 4s^1$ OR $1s^2 2s^2 2p^6 3s^2 3p^6 4s^1 3d^{10}$
- **Remember:** Copper atoms prefer a complete d subshell

Answer 2 – Mn(III):

- **Step 1:** Write out the electron configuration of the atom first:
 - Mn atomic number = 25
 - $1s^2 2s^2 2p^6 3s^2 3p^6 4s^2 3d^5$
- **Step 2:** Subtract the appropriate number of electrons starting from the 4s subshell
 - Mn(III) = 22 electrons
 - $1s^2 2s^2 2p^6 3s^2 3p^6 3d^4$

Answer 3 – V^{4+} :

- **Step 1:** Write out the electron configuration of the atom first:
 - V atomic number = 23
 - $1s^2 2s^2 2p^6 3s^2 3p^6 3d^3 4s^2$
- **Step 2:** Subtract the appropriate number of electrons starting from the 4s subshell
 - V^{4+} = 19 electrons
 - $1s^2 2s^2 2p^6 3s^2 3p^6 3d^1$

- When transition elements form ions they lose electrons from the **4s** subshell first
- This is because when the orbitals are occupied, the repulsion between electrons pushes the **4s** into a higher energy state so that it now becomes slightly higher in energy than the **3d** subshell
 - The **4s** is now the outer shell and loses electrons first
- The loss of the **4s** electrons means that **+2** is a common oxidation state in transition metals
- The reason why the transition metals have variable oxidation states all comes down to energy

Table showing the common oxidation states of transition elements



Your notes

Element	Most common oxidation states
Ti	+3, +4
V	+3, +5
Cr	+3, +6
Mn	+2, +4, +7
Fe	+2, +3
Co	+2, +3
Ni	+2
Cu	+1, +2

Explaining variable oxidation states using successive ionisation energies

- Using titanium and vanadium as examples, the graph below shows that the first few ionisation energies are relatively small and relatively close together
 - This means that the energy difference associated with removing a small number of electrons enables transition metals to vary their oxidation state with ease

Graph of titanium and vanadium ionisation energies



Your notes

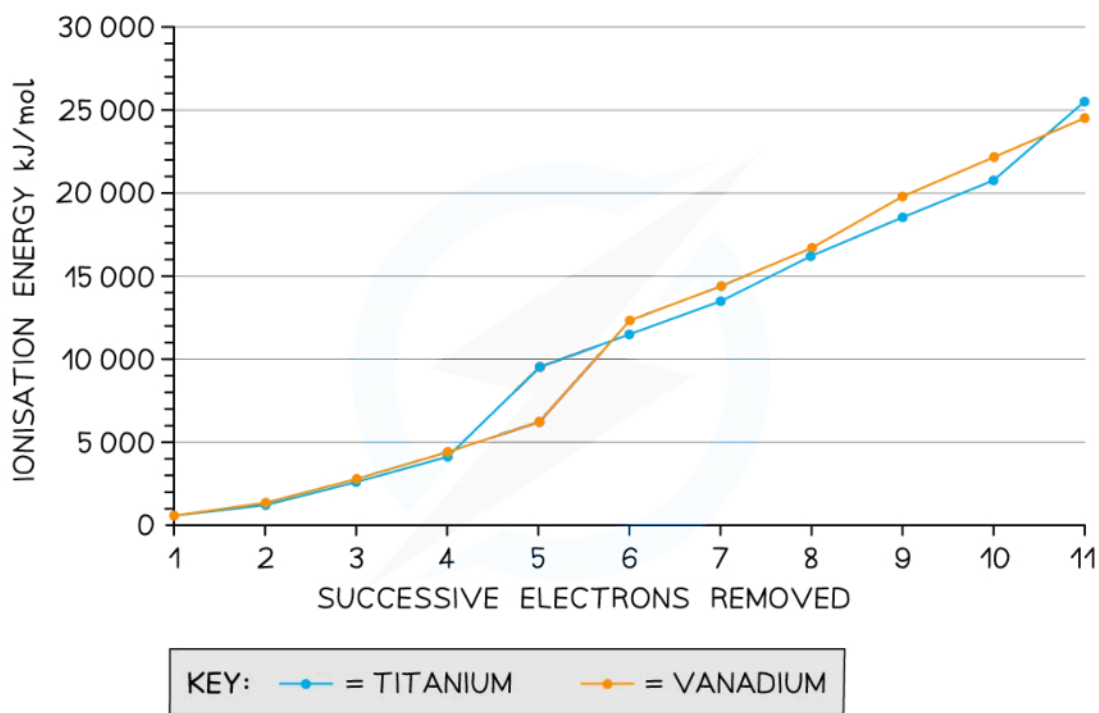

Ionisation energies increase for the removal of successive electrons in titanium and vanadium

- The +2 and +3 oxidation states are shown by all the transition elements
 - The +3 state is more stable in the elements up to chromium
 - The +2 state is more stable in the later elements
- Transition metal ions with oxidation state +3 and above tend to be polarising and have a degree of covalent character in the bonds they form
 - The ions have a high charge density and pull electrons towards themselves
- The maximum oxidation state possible corresponds to the total number of electrons in the 4s and 3d which reaches a maximum at manganese
 - An example you may be familiar with is the manganate(VII) ion, MnO_4^- which is a powerful oxidising agent

💡 Examiner Tip

- You may sometimes see electronic configurations with:
 - 3d electrons written before 4s
 - 4s electrons written before 3d
- Both ways are acceptable although putting the 3d electrons first is more conventional, even though 4s fills before 3d



Your notes

Colour in Transition Metal Complexes (HL)

Colour in Transition Metal Complexes

- Transition elements form coloured complexes when they bond with ligands
- Ligands are molecules, such as ammonia and water, or ions, such as ammonium or chloride ions that form a coordinate bond to a central metal ion
 - For more information, see our revision note on [Coordination Bonds](#)

Crystal Field Theory (CFT)

- The crystal field theory is a model based on electrostatic point charges and is used to explain colour in transition metal compounds
- In a transition metal atom, the five orbitals that make up the d-subshell all have the same energy
 - The term for this is **degenerate**
- However, when ligands are attached to a transition metal ion, the electric field formed by the lone pairs of electrons on the ligands repel the electrons in the d-subshell causing the d-orbitals to split in energy
- The dative bonding from the ligands causes the five d orbitals to split into two sets
- These two sets are **not** equal in energy and are described as being **non-degenerate** orbitals

The effect of ligands on the d-orbitals of a central transition metal ion

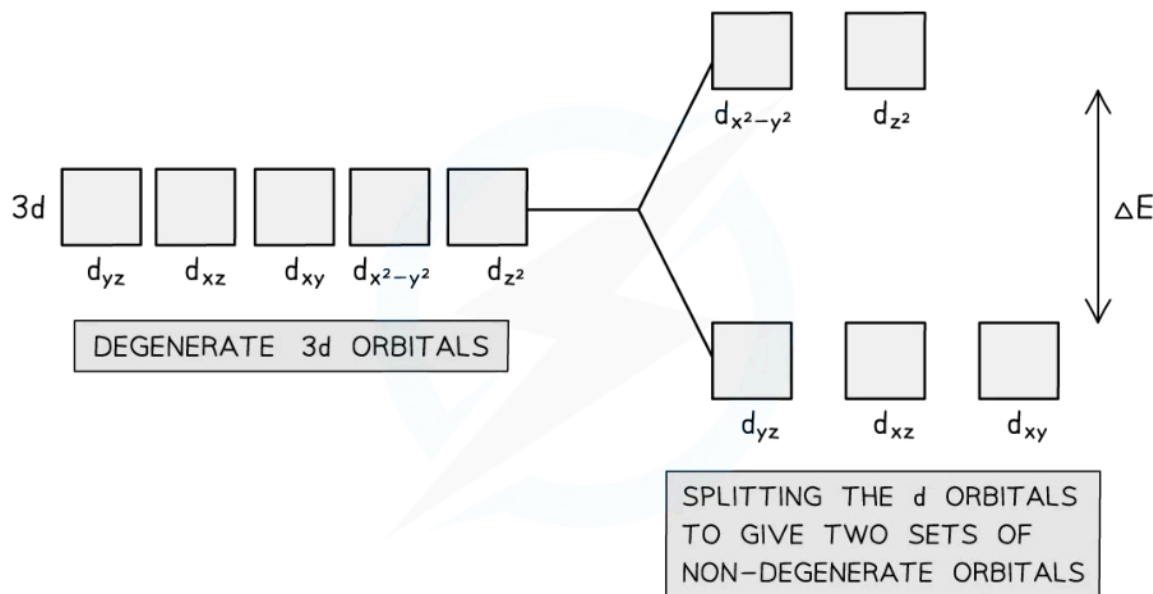

Upon bonding to ligands, the d orbitals of the transition element ion split into two non-degenerate sets of orbitals

- The central metal ion in a complex has five d-orbitals for the electrons

Diagram showing the shapes and orientation of the five d-orbitals

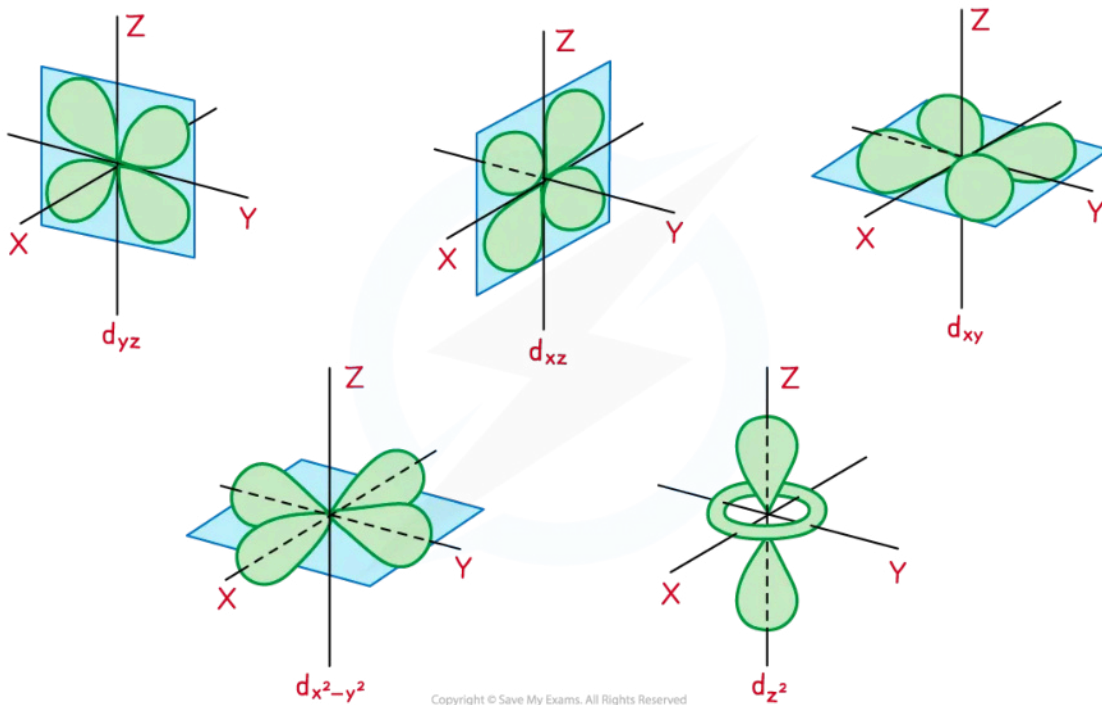

The names of the different d-orbitals are based on their position in the x, y and z planes. The shapes are shown here for reference only. You are not required to know the shapes of d-orbitals in the exam

Perception of colour

- Most transition metal compounds appear coloured
- This is because the difference in energy between the non-degenerate orbitals allows electrons in the lower energy orbitals to be **promoted** into the higher energy orbitals
 - A larger splitting of the d-orbitals means that more energy is required to promote an electron
- This happens when the complex absorbs light energy with a wavelength corresponding to the energy gap between the orbitals
 - With a larger splitting of d-orbitals, light of a shorter wavelength and higher frequency is absorbed
- The amount of energy absorbed relates to certain parts of the visible **electromagnetic spectrum**
- The colour that is seen is **complementary** to the colour that is absorbed, i.e. it is made up of the parts of the visible spectrum that aren't absorbed
 - For example, a green compound will absorb all frequencies of the spectrum apart from green light, which is transmitted

The colour wheel

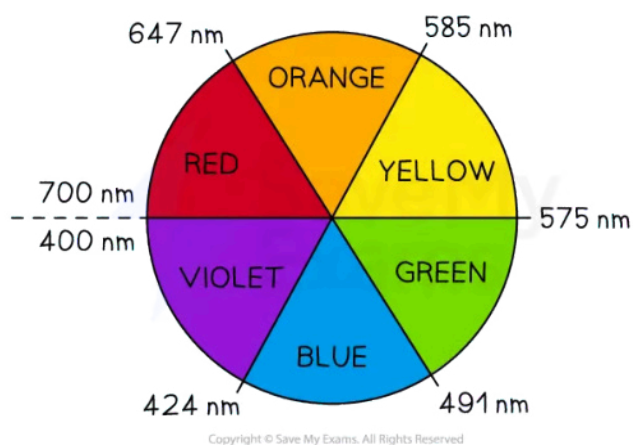

The colour wheel shows complementary colours in the visible light region of the electromagnetic spectrum

- Complementary colours are any two colours which are directly opposite each other in the colour wheel
 - For example, the complementary colour of red is green and the complementary colours of red-violet are yellow-green

Examiner Tip

- The colour wheel is given section 15 in the Data booklet, so there is no need to learn it
- There are different splitting patterns possible but you are not required to know different splitting patterns or their relation to coordination number.

Absorption of light

- When white light passes through a solution of aqueous nickel(II) sulfate, an electron in the lower energy d-orbitals is excited and jumps up into the higher energy d-orbitals
- A **photon** of red light is absorbed and light of the complementary colour (green) is transmitted
- This is why nickel(II) sulfate solution appears green
- The energy of the separation is ΔE corresponding to a wavelength of about 647 - 700 nm

Illustration of the electron promotion process in Nickel(II)

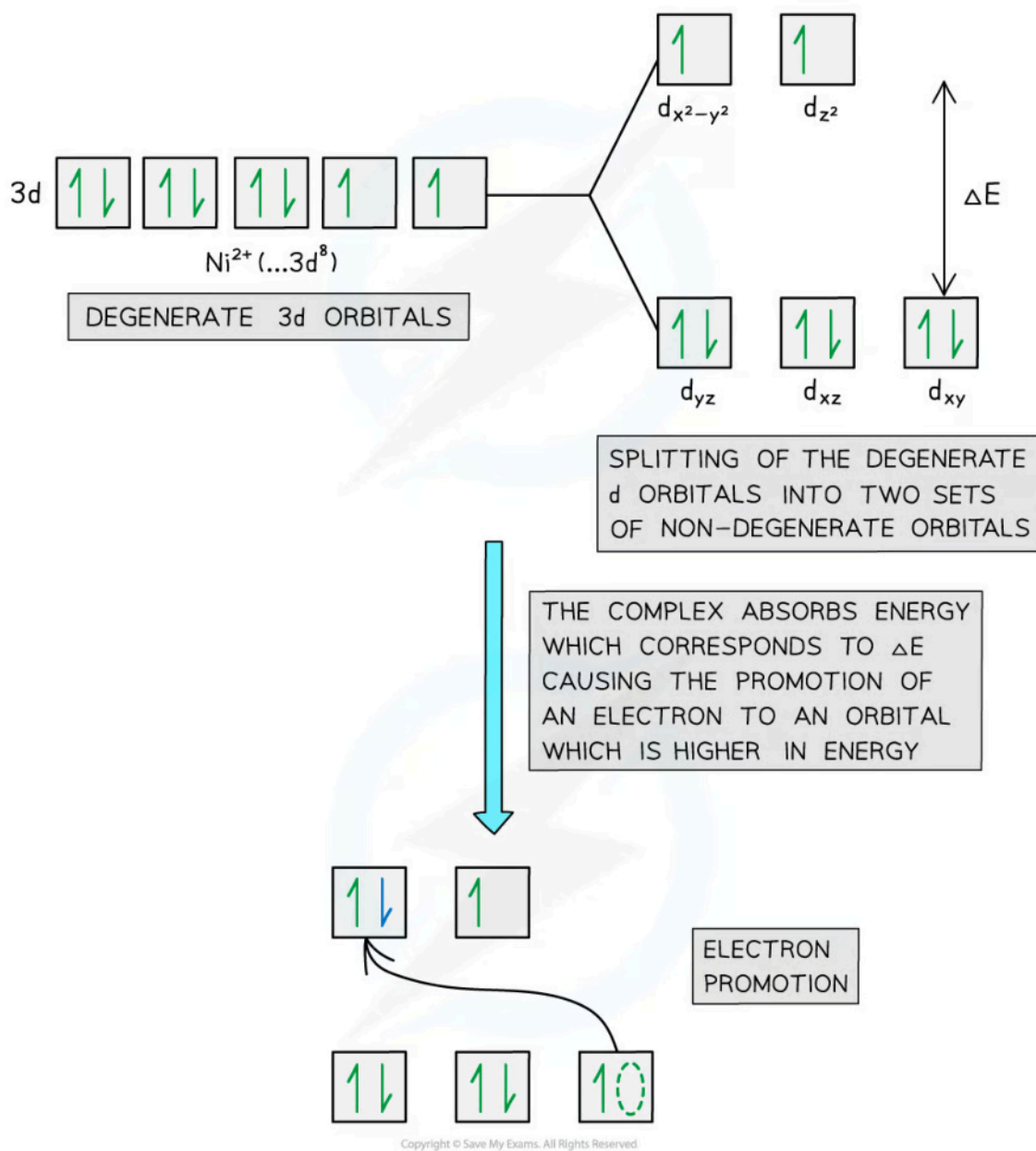

During electron promotion of a Ni(II) complex, an electron jumps from a d_x orbital to a $d_{x^2-y^2}$ orbital when light is shone on the solution



Your notes

Worked example

Titanium(III) sulfate forms a purple aqueous solution. Estimate the wavelength of light absorbed by this solution, using Section 15 of the data booklet.

Answer:

- Titanium(III) sulfate appears purple
- The complementary colour of yellow is absorbed
- The wavelength range of the complementary colour is **575 – 585 nm**

Wavelength, frequency and energy

- A greater splitting of the d-orbitals results in a larger energy gap, ΔE
- This means that more energy is needed to promote an electron from a lower to a higher energy orbital
- Therefore, the light needs to have:
 - Shorter wavelength
 - Higher frequency
- The equations relating wavelength, frequency and energy are:

$$\begin{array}{ccccc}
 \text{speed of light} & & \text{frequency} & & \text{wavelength} \\
 (3.00 \times 10^8 \text{ m s}^{-1}) & = & (\text{s}^{-1}) & \times & (\text{m}) \\
 \mathbf{c} & & \mathbf{f} & & \mathbf{\lambda}
 \end{array}$$

$$\begin{array}{ccccc}
 \text{energy} & & \text{Planck's constant} & & \text{frequency} \\
 (\text{J}) & = & (6.63 \times 10^{-34} \text{ J s}) & \times & (\text{s}^{-1}) \\
 \mathbf{E} & & \mathbf{h} & & \mathbf{f}
 \end{array}$$

- These are given in Section 1 of the Data Booklet, so there is no need to memorise them, although you do need to know how to manipulate them and what the units are
- The constants are listed in Section 2 of the data Booklet